

***2ELD2-RS Series Servo
Drives User Manual***

Ver 1.0

Foreword

Thanks for purchasing Leadshine 2ELD2-series low-voltage DC servo drive, this instruction manual provides knowledge and attention for using this driver.

Contact tech@leadshine.com for more technical support .

Incorrect operation may cause unexpected accident, please read this manual carefully before using product.

- ✧ We reserve the right to modify equipment and documentation without prior notice.
- ✧ We won't undertake any responsibility with customer's any modification of product, and the warranty of product will be cancel at the same time.

Be attention to the following warning symbol:



Warning

indicates that the error operation could result in loss of life or serious injury.



Caution

indicates that the error operation could result in operator injured, also make equipment damaged.



Attention

indicates that the error use may damage product and equipment.

Safety precautions



Warning

- The design and manufacture of product doesn't use in mechanic and system which have a threat to operator.
- The safety protection must be provided in design and manufacture when using this product to prevent incorrect operation or abnormal accident.

Transportation



Caution

- The storage and transportation must be in normal condition.
- The product should be packaged properly in transportation,
- Don't hold the product by the cable, motor shaft or encoder while transporting it.
- The product can't undertake external force and shock.

Installation



Caution

Servo Driver and Servo Motor:

- Don't install them on inflammable substance or near it to preventing fire hazard.
- Avoid vibration, prohibit direct impact.
- Don't install the product while the product is damaged or incomplete.

Servo Drive:

- Must install in control cabinet with sufficient safeguarding grade.
- Must reserve sufficient gap with the other equipment.
- Must keep good cooling condition.
- Avoid dust, corrosive gas, conducting object, fluid and inflammable, explosive object from invading.

Servo Motor:

- Installation must be steady, prevent drop from vibrating.

- Prevent fluid from invading to damage motor and encoder.
- Prohibit knocking the motor and shaft, avoid damaging encoder.
- The motor shaft can't bear the load beyond the limits.

Wiring



Warning

- The workers of participation in wiring or checking must possess sufficient ability do this job.
- Ground the earth terminal of the motor and driver without fail.
- The wiring should be connected after servo driver and servo motor installed correctly.
- After correctly connecting cables, insulate the live parts with insulator.



Caution

- The wiring must be connected correctly and steadily, otherwise servo motor may run incorrectly, or damage the equipment.
- We mustn't connect capacitors, inductors or filters between servo motor and servo driver.
- The wire and temperature-resistant object must not be close to radiator of servo driver and motor.
- The freewheel diode which connect in parallel to output signal DC relay mustn't connect reversely.

Debugging and running



Caution

- Make sure the servo drive and servo motor installed properly before power on, fixed steadily, power voltage and wiring correctly.
- The first time of debugging should be run without loaded, debugging with load can be done after confirming parameter setting correctly, to prevent mechanical damage because of error operation.



Caution

- Install a emergency stop protection circuit externally, the protection can stop running immediately to prevent accident happened and the power can be cut off immediately.
- The run signal must be cut off before resetting alarm signal, just to prevent restarting suddenly.
- The servo driver must be matched with specified motor.
- Don't power on and off servo system frequently, just to prevent equipment damaged.
- Forbidden to modify servo system.

Fault Processing



Caution

- The reason of fault must be figured out after alarm occurs, reset alarm signal before restarting the power.
- Keep away from machine, because of restarting suddenly if the driver is powered on again after momentary interruption(the design of the machine should be assured to avoid danger when restart occurs)

System selection



Attention

- The rate torque of servo motor should be larger than effective continuous load torque.
- The ratio of load inertia and motor inertia should be smaller than recommended value.
- The servo driver should be matched with servo motor.

Table of Contents

Foreword	2
Chapter 1 Introduction.....	6
1.1 Inspection of product.....	6
1.2 Specification and feature	7
1.3 Part Number	7
Chapter 2 Installation	8
2.1 Storage and Installation Circumstance	8
2.2 Servo Driver Installation	9
2.2.1 Installation Method.....	9
2.2.2 Installation Space.....	10
2.3 Servo Motor Installation.....	10
Chapter 3 Wiring	11
3.1 Wiring.....	11
3.1.1 Wire Gauge.....	11
3.1.2 Wiring.....	12
3.2 Driver Terminals Function.....	13
3.2.1 Power Terminal - Axis 1 and Axis 2.....	13
3.2.2 Encoder Input Port- Axis 1 or Axis 2	13
3.2.3 Control signal I/O-Port of CN1 and CN2.....	14
3.2.4 Communication Port.....	15
3.2.5 RS485 Bus Connector	15
3.2.5 STO Connector.....	16
3.2.7 RS485 Node-ID and Baud rate switch	16
3.3 I/O Interface Principle	17
3.3.1 Digital Input Interface	17
3.3.2 Digital Output Interface.....	17
3.3.3 Pulse Input Interface.....	17
Chapter 4 Parameter	19
4.1 Parameter List.....	19
4.2 Parameter Function.....	24
4.2.1 【Class 0】 Basic Setting	24
4.2.2 【Class 1】 Gain Adjust	29
4.2.3 【Class 2】 Vibration Suppression.....	34
4.2.4 【Class 3】 Velocity/ Torque Control.....	36
4.2.5 【Class 4】 I/F Monitor Setting	41
4.2.6 【Class 5】 Extended Setup	47
4.2.7 【Class 6】 Special Setup.....	51
4.2.8 【Class 7】 Factory setting.....	53
4.2.8 【Class B】 Status Information	54
Chapter 5 Trial Run	58
5.1 Inspection Before trial Run	58
5.1.1 Inspection on wiring	58
5.1.2 Timing chart on power-up	59
5.1.3 Timing chart on fault	59
5.1.4 Holding brake	59
5.2 Position Control.....	60
5.2.1 Pulse command and rotation direction	62
5.2.2 Electronic gear function	62
5.2.3 Position command filter	63
5.2.4 Motor encoder pulse output.....	64
5.2.5 Position complete output (INP).....	65
5.3 Velocity Control	66
5.3.1 Velocity mode control by internal speed command.....	66
5.3.2 Speed command acceleration and deceleration	69
5.3.3 Attained Speed signal AT-SPEED output	70

5.3.4 Velocity coincidence output (V-COIN)	71
5.3.5 Speed zero clamp (ZEROSPD)	71
5.4 Torque Control.....	72
5.4.1 Torque limit function	72
5.5 Multi-turn absolute encoder	73
5.5.1 Parameters setting.....	73
5.5.2 Reading absolute position.....	74
5.5.3 Alarm.....	74
5.6 Security Features	76
5.6.1 Speed limit.....	76
5.6.2 BRK-OFF output.....	76
5.6.3 Servo stop mode	77
5.6.4 Emergency stop function	77
5.7 Inertia ratio identification	78
5.7.1 On-line inertia ratio identification	78
5.7.2 Motion Studio inertia ratio identification	78
5.8 Vibration Suppression	79
5.9 Third gain switching.....	81
5.10 Friction torque compensation	82
5.11 Regenerative resistor setting.....	82
Chapter6 Pr-Mode	84
6.1 Overview	84
6.1.1 Main function	84
6.1.2 Installation wiring.....	85
6.2 Pr-Mode Parameters	87
6.2.1 8th parameters specification	87
6.2.2 9th parameters specification	88
6.3 Pr-Mode motion control	89
6.3.1 Homing.....	89
6.3.2 Position limit and E-stop	91
6.3.3 JOG.....	91
6.3.4 Path Motion	91
6.4 Execute Movement of Pr-Mode	94
6.4.1 Execute movement by Configuration software	94
6.4.2 Execute movement by digital signal.....	96
6.4.3 Execute movement by RS485 Communication	98
6.4.4 Fixed trigger method	101
6.4.5 Immediately trigger method	102
6.5 Operation Examples	103
6.5.1 Execute movement by digital signal.....	103
6.5.2 Execute movement by RS485 Communication	105
Chapter 7 Alarm and Processing	111
7.1 Alarm List.....	111
6.2 Alarm Processing Method	113
Appendix	121
A. Modbus Communication	121
A.1 Wiring.....	121
A.2 Parameters and interface for communication	121
A.3 Modbus Protocol	122
A.4 RS485 common problems and solutions	125
Contact us.....	126

Chapter 1 Introduction

The 2ELD2 series is a new low voltage DC servo drive developed from Leadshine, dual-axis, that one 2ELD2 drive can drive two servo motors at the same time. 2ELD2 series keep the same performance of ELD2 series, relying on the special dual-axis structure, 2ELD2 series achieve less wiring, space saving, energy saving, while having a high cost performance.

Talent feature:

- ✓ Compact size, dual-axis design
- ✓ Wide voltage input range: 24~70VDC
- ✓ High current driving ability: 2 x up to 30Arms continuous/ 90A peak
- ✓ STO(SIL3, TUV certification pending)
- ✓ Auxiliary logic input power
- ✓ Direct brake output function
- ✓ Pulse + direction
- ✓ Modbus based on RS485

1.1 Inspection of product

1. **Check the following thing before using the products :**
 - a. Check if the product is damaged or not during transportation.
 - b. Check if the servo driver & motor are complete or not.
 - c. Check the packing list if the accessories are complete or not

The 2ELD2 series DC servo driver can be matched with ELVM Low-voltage DC servo motor

Matched Motors	
Power Range	Up to 1200W for each axis
Motor Supported	Brushless、 Brushed
Voltage Range	24 - 70Vdc
Feedback supported	<ul style="list-style-type: none"> ✓ Incremental TTL signal encoder (5V) ✓ LeadShine 17bit serial signal encoder ✓ Hall sensor
Motor Size	40mm,42mm,57mm,60mm,80mm frame,110mm frame or other size
Other Requirements	Brake. oil-seal. protection level. Shaft &connector can be customized

1.2 Specification and feature

Specifications			
Drive model		2ELD2-RS7020B	2ELD2-RS7030B
Size(mm)		194*103*41	
Input main voltage(V)		DC24~70	
Input auxiliary power(V)		DC24~70	
Rated power(kw) / Axis		0.75	1.2
Rated output current(Arms) / Axis		20	30
Max output current(Apeak) / Axis		60	90
Main power	Voltage(V)	DC24V-70V	DC24V-70V
	Current/Axis	20Arms ($\leq 48Vdc$) 14Arms ($> 48Vdc$)	30Arms($\leq 48Vdc$) 21Arms ($> 48Vdc$)
Control power	Voltage(V)	DC12-24	
	Current(mA)	≥ 12	
Control method		IGBT PWM sinusoidal Wave Drive	
Overload		300%	
Regenerative resistor		External connection	
Safe function		STO(SIL3)	
Protection rank		IP20	

Communication & Connection	
Communication	Modbus based on RS485
Inputs/Outputs	4 programmable digital inputs 2 programmable digital outputs
Pulse+direction	Yes
Brake Output (24vdc)	Yes
Feedback Supported	<ul style="list-style-type: none"> ✓ Incremental TTL signal encoder (5V) ✓ LeadShine 17bit serial signal encoder ✓ Hall sensor

1.3 Part Number

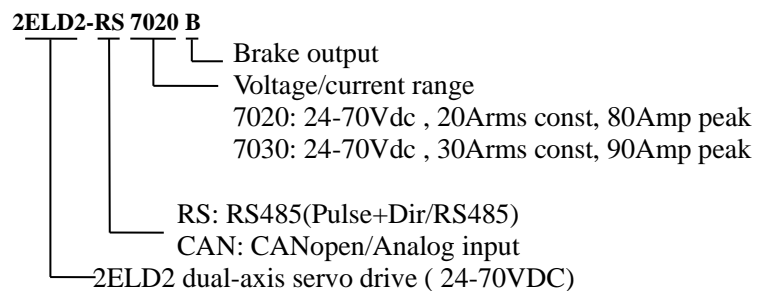

Chapter 2 Installation

2.1 Storage and Installation Circumstance

Table 2.1 Servo Driver, Servo Motor Storage Circumstance Requirement

Item	2ELD2 series driver	ELVM low voltage servo motor
Temperature	-20-80°C	-25-70°C
Humidity	Under 90%RH (free from condensation)	Under 80%RH (free from condensation)
Atmospheric environment	Indoor (no exposure) no corrosive gas or flammable gas, no oil or dust	Indoor (no exposure) no corrosive gas or flammable gas, no oil or dust
Altitude	Lower than 1000m	Lower than 2500m
Vibration	Less than 0.5G (4.9m/s ²) 10-60Hz (non-continuous working)	
Protection level	IP00 (no protection)	IP54

Table 2.2 Servo Driver, Servo Motor Installation Circumstance Requirement

Item	2ELD2 series driver	ELVM low voltage servo motor
Temperature	0-55°C	-25-40°C
Humidity	Under 90%RH (free from condensation)	Under 90%RH (free from condensation)
Atmospheric environment	Indoor (no exposure) no corrosive gas or flammable gas, no oil or dust	Indoor (no exposure) no corrosive gas or flammable gas, no oil or dust
Altitude	Lower than 1000m	Lower than 2500m
Vibration	Less than 0.5G (4.9m/s ²) 10-60Hz (non-continuous working)	
Protection level	IP00 (no protection)	IP54

2.2 Servo Driver Installation

Notice

- Must install in control cabinet with sufficient safeguarding grade.
- Must install with specified direction and intervals, and ensure good cooling condition.
- Don't install them on inflammable substance or near it to prevent fire hazard.

2.2.1 Installation Method

Install in vertical position ,and reserve enough space around the servo driver for ventilation.

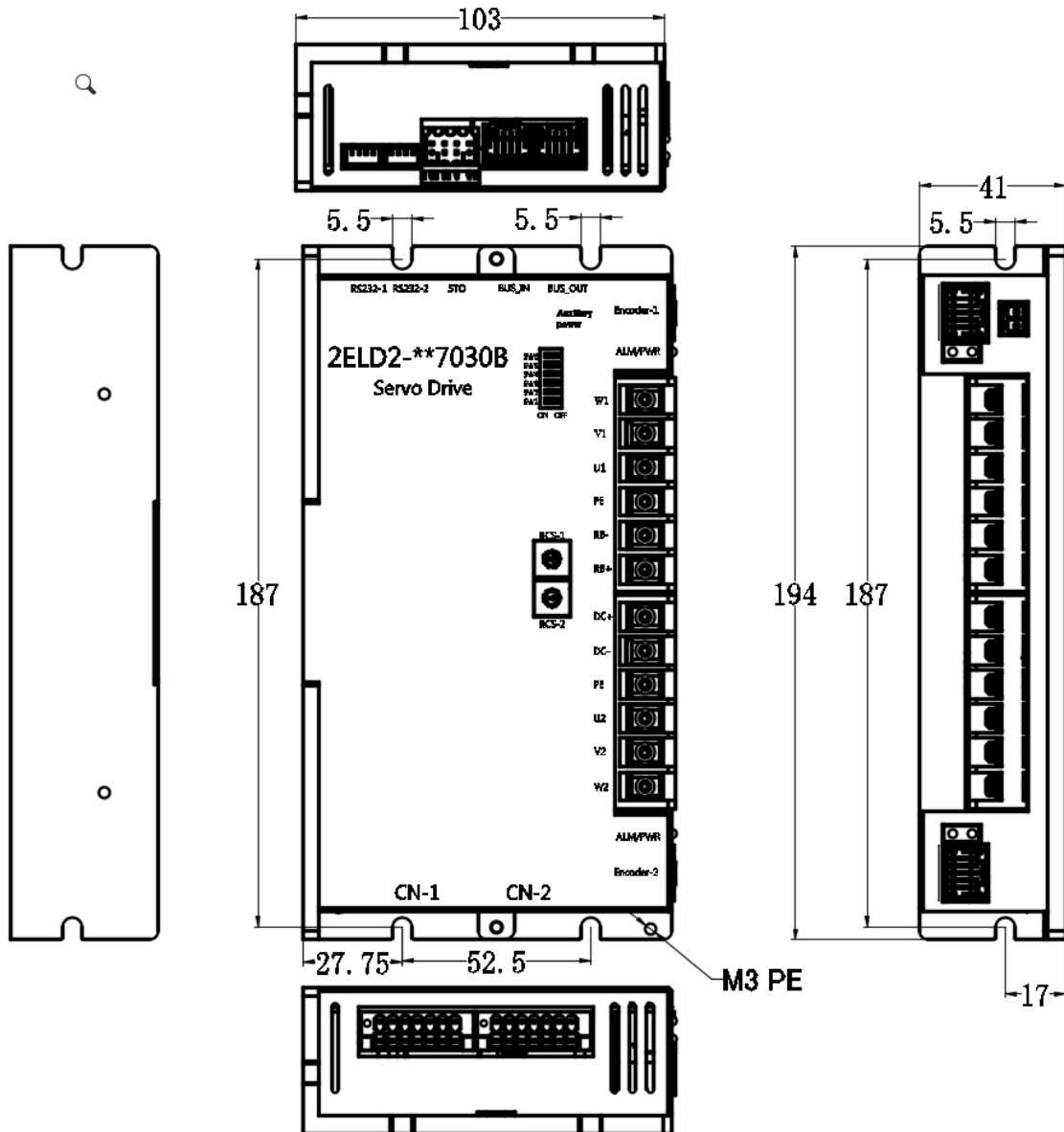

Figure 2.1 installation method of drive 2ELD2-RS7020B/2ELD2-RS7030B

2.2.2 Installation Space

Reserve enough surrounding space for effective cooling.

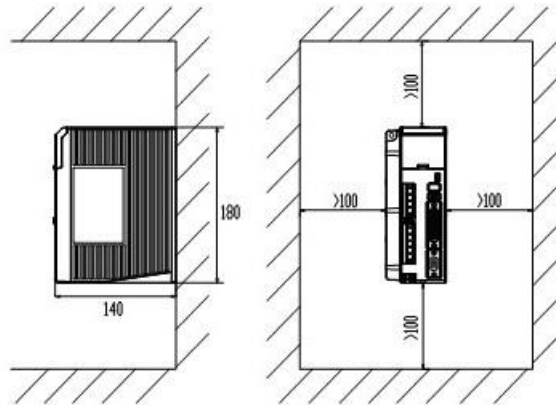

Figure 2.2 Installation Space for Single Driver

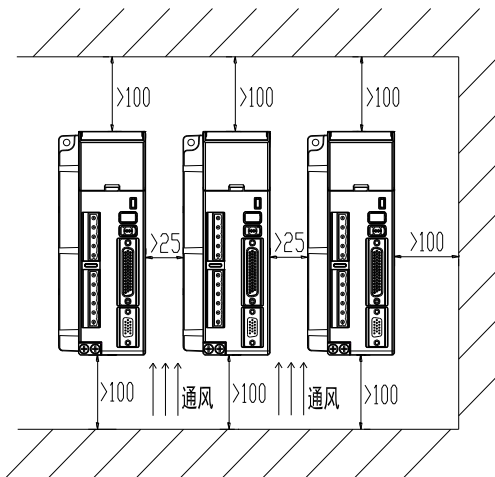

Figure 2.3 Installation Space for several Drivers

2.3 Servo Motor Installation

Notice

- Don't hold the product by the cable, motor shaft or encoder while transporting it.
- No knocking motor shaft or encoders, prevent motor by vibration or shock.
- The motor shaft can't bear the load beyond the limits.
- Motor shaft does not bear the axial load, radial load, otherwise you may damage the motor.
- Use a flexible with high stiffness designed exclusively for servo application in order to make a radial thrust caused by micro misalignment smaller than the permissible value.
- Install must be steady, prevent drop from vibrating.

Chapter 3 Wiring



Warning

- The workers of participation in wiring or checking must possess sufficient ability do this job.
- The wiring and check must be going with power off after five minutes.



Caution

- Ground the earth terminal of the motor and driver without fail.
- The wiring should be connected after servo driver and servo motor installed correctly

3.1 Wiring

3.1.1 Wire Gauge

(1) Power supply terminal TB

- Diameter:

Driver	Wire diameter (mm ² /AWG)		
	Vdc、GND	U、V、W	PE
2ELD2-RS7020B	AWG14	AWG14	AWG14
2ELD2-RS7030B	AWG12	AWG12	AWG12

- Grounding: The grounding wire should be as thick as possible, drive servo motor the PE terminal point ground, ground resistance <math><100 \Omega</math>.

- Use noise filter to remove external noise from the power lines and reduce an effect of the noise generated by the servo driver.

- Install fuse (NFB) promptly to cut off the external power supply if driver error occurs.

(2) The control signal CN1 /CN2 , feedback signal ENC-1/ENC-2

- **Diameter:** shielded cable (twisting shield cable is better), the diameter $\geq 0.14\text{mm}^2$ (AWG24-26), the shield should be connected to FG terminal.
- **Length of line:** cable length should be as short as possible and control CN1/CN2 cable is no more than 3 meters, the encoder cable length of the feedback signal is no more than 20 meters.
- **Wiring:** be away from the wiring of power line, to prevent interference input.
- Install a surge absorbing element for the relevant inductive element (coil); DC coil should be in parallel connection with freewheeling diode reversely; AC coil should be in parallel connection with RC snubber circuit.

(3) Regenerative resister

When the torque of the motor is opposite to the direction of rotation (common scenarios such as deceleration, vertical axis descent, etc.), energy will feedback from the load to the drive. At this time, the energy feedback is first received by the capacitor in the drive, which makes the voltage of the capacitor rise. When it rises to a certain voltage value, the excess energy needs to be consumed by the regenerative resistance

The recommended regenerative resistance specifications for the ELD2 series are as follows:

Drive	Recommend resister value (Ω)	Recommend resister power (W)
2ELD2-RS7020B	10	100
2ELD2-RS7030B	10	100 or 150

Method for determining regenerative resistance specification

- Firstly, use the built-in resistance of the drive to run for a long time to see if it can meet the requirements: ensure that the drive temperature $d33 < 60^\circ\text{C}$, the braking circuit does not alarm (Regeneration load factor $d14 < 80$), and the drive does not report overvoltage error
- If the drive temperature is high, try to reduce the regenerative energy power, or external resistance of the same specification (in this case, cancel the built-in resistance).
- If the brake resistance burns out, try to reduce the regenerative energy power, or put an external resistance of the same specification or even more power (in this case, cancel the built-in resistance).

- If d14 is too large or accumulates too fast, it means that the regenerative energy is too large, and the built-in resistance cannot consume the generated energy, the regenerative energy power will be reduced, or the external resistance with higher resistance value or power will be reduced.

If an overvoltage error is reported by the drive, the regenerative energy power is reduced, or a resistance with a smaller external resistance, or a parallel resistance.

The recommended regenerative resistance specifications for most application of 2ELD2 are as follows:

10Ω+/-5%, 100w,

Part number : RXFB-1, Code : 10100469



Attention

- Match the colors of the motor lead wires to those of the corresponding motor output terminals (U.V.W)
- Never start nor stop the servo motor with this magnetic contactor.

3.1.2 Wiring

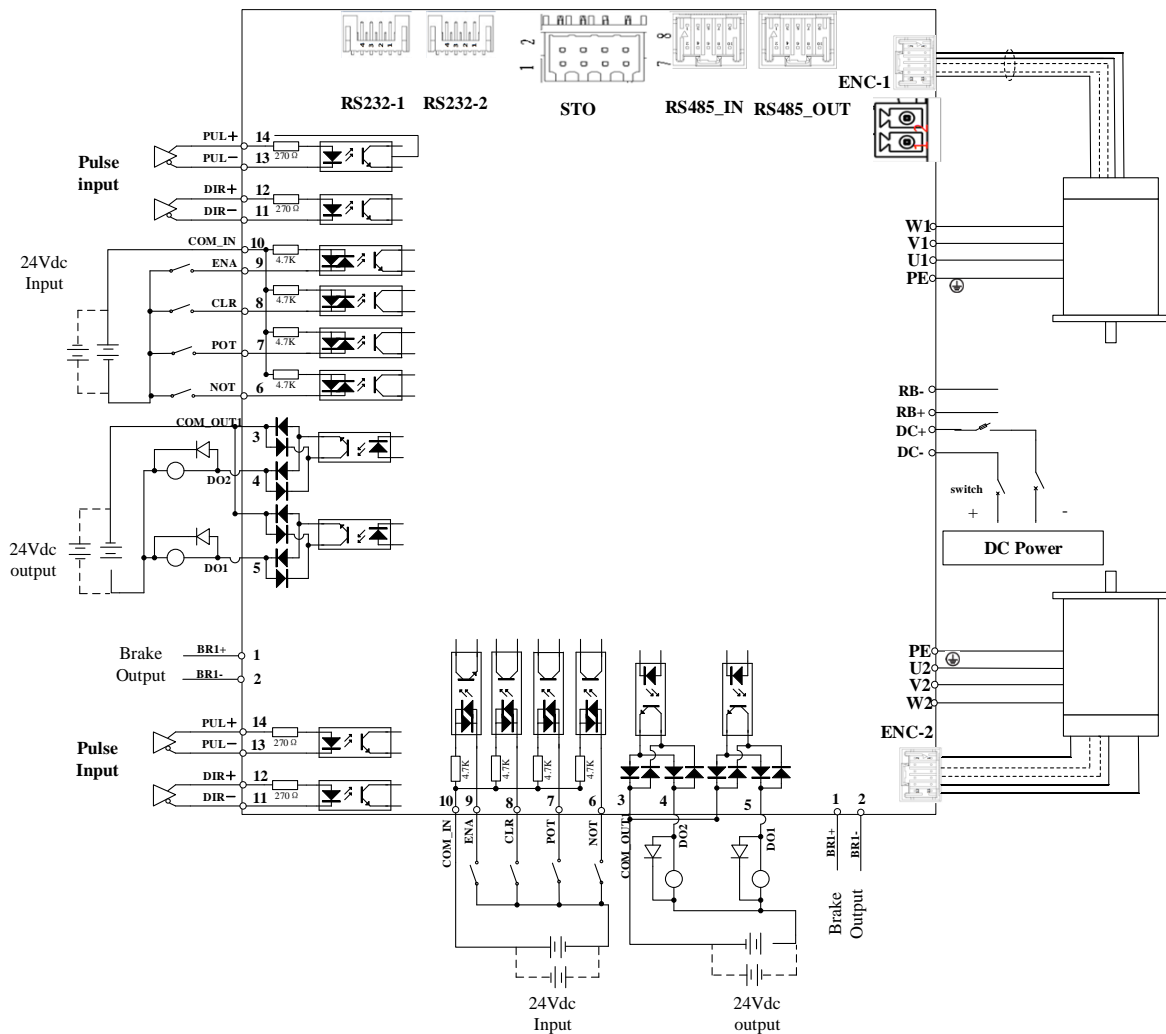

Figure 3-1 Position Mode Wiring

Notes:

1. Only support 5V pulse and direction signal, 2KΩ resistor must installed with 24V pulse and direction signal.
2. 4 digital inputs DI3~DI6, support NPN and PNP connection, recommend 12~24V input signal.
3. 2 digital outputs DO1~DO2, support NPN and PNP connection, recommend 24V output signal.

3.2 Driver Terminals Function

3.2.1 Power Terminal - Axis 1 and Axis 2

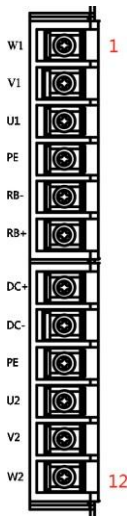
Power terminal	Pin	Signal	Input / Output	Details
	1	W1	Output	Power for motor 1
	2	V1	Output	
	3	U1	Output	
	4	PE	Output	
	5	RB-	Input	Regenerative resistor Note : Pls check 3.1.1 about how to use the right external resistor
	6	RB+	Input	
	7	DC+	Output	Power for Drive: DC24~70V
	8	DC-	Output	
	9	PE	Output	Power for motor 2
	10	U2	Output	
	11	V2	Output	
	12	W2	Output	

Auxiliary Power Terminal

Auxiliary power		Pin	Detail
Auxiliary power		1	VCC+
		2	GND

3.2.2 Encoder Input Port- Axis 1 or Axis 2

For motor with incremental encoder :

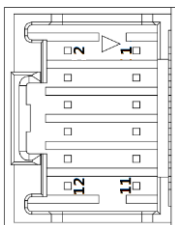
Encoder	Pin	Signal	IO	Detail
	1	SHIELD	Input	Ground terminal for shielded
	2	HU	Input	Hall sensor U input
	3	HW	Input	Hall sensor W input
	4	HV	Input	Hall sensor V input
	5	VCC	Input	+5V for encoder power supply
	6	GND	Input	
	7	EZ+	Input	Encoder channel Z+ input
	8	EZ-	Input	Encoder channel Z- input
	9	EB+	Input	Encoder channel B+ input
	10	EB-	Input	Encoder channel B- input
	11	EA+	PE	Encoder channel A+ input
	12	EA-	Input	Encoder channel A- input

For motor with serial encoder :

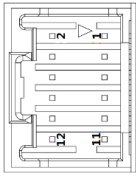
Encoder	Pin	Signal	IO	Detail
	1	SHIELD	Input	Ground terminal for shielded
	5	VCC	Input	+5V for encoder power supply
	6	GND	Input	
	7	D+	Input	Serial encoder signal
	8	D-	Input	Serial encoder signal

3.2.3 Control signal I/O-Port of CN1 and CN2

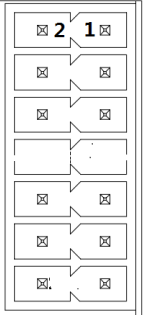
CN-1	Pin	Signal	IO	Detail	
	1	BR+	Output	Brake output, 24V/1A	
	2	BR-	Output		
	3	COM_OUT	Output	Digital output signal commonality ground, 24V	
	4	DO2	Output	Digital output signal 2 , (Servo-Ready) 24V, 8mA	
	5	DO1	Output	Digital output signal 1 , (ALARM) 24V, 8mA	
	6	DI6	Input	Digital input signal 6, default value is reverse run prohibited (NOT) signal in position mode , low level available in default , max voltage is 24V input 20KHz	
	7	DI5/POT	Input	Digital input signal 5, default value is forward run prohibited (POT)signal in position mode , low level available in default , max voltage is 24V input 20KHz	
	8	DI4/A-CLR	Input	Digital input signal 4, default value is alarm clear signal , low level available in default , max voltage is 24V input 20KHz	
	9	DI3/ENA	Input	Digital input signal 3, default value is forward enable signal , low level available in default , max voltage is 24V input 20KHz	
	10	COM_IN	Input	Power supply positive terminal of the external input control signal, 12V ~ 24V	
	11	DI2-/DIR-	Input	Negative differential direction input, 5-24V, 500KHz	Pulse + direction , 2KΩ resistor is needed if the voltage is 24Vdc
	12	DI2+/DIR+	Input	Positive differential direction input, 5-24V, 500KHz	
	13	DI1-/PUL-	Input	Negative differential pulse input, 5-24V, 500KHz	
	14	DI1+/PUL+	Input	Positive differential pulse input, 5-24V, 500KHz	

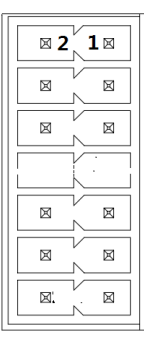
CN-2	Pin	Signal	IO	Detail	
	1	BR+	Output	Brake output, 24V/1A Note : pls check more details from Pr437/ Pr438 of Chapter	
	2	BR-	Output		
	3	COM_OUT	Output	Digital output signal commonality ground, 24V	
	4	DO2	Output	Digital output signal 2 , (Servo-Ready) 24V, 8mA	
	5	DO1	Output	Digital output signal 1 ,(Alarm)24V, 8mA	
	6	DI6	Input	Digital input signal 6, default value is reverse run prohibited (NOT) signal in position mode , low level available in default , max voltage is 24V input 20KHz	
	7	DI5/POT	Input	Digital input signal 5, default value is forward run prohibited (POT)signal in position mode , low level available in default , max voltage is 24V input 20KHz	
	8	DI4/A-CLR	Input	Digital input signal 4, default value is alarm clear signal , low level available in default , max voltage is 24V input 20KHz	
	9	DI3/ENA	Input	Digital input signal 3, default value is forward enable signal , low level available in default , max voltage is 24V input 20KHz	
	10	COM_IN	Input	Power supply positive terminal of the external input control signal, 12V ~ 24V	
	11	DI2-/DIR-	Input	Negative differential direction input, 5-24V, 500KHz	Pulse + direction , 2KΩ resistor is needed if the voltage is 24Vdc
	12	DI2+/DIR+	Input	Positive differential direction input, 5-24V, 500KHz	
	13	DI1-/PUL-	Input	Negative differential pulse input, 5-24V, 500KHz	
	14	DI1+/PUL+	Input	Positive differential pulse input, 5-24V, 500KHz	

3.2.4 Communication Port

RS232 Communication port for GUI software- Axis 1 or Axis 2

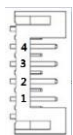
RS232		Pin	Detail
RS232		1	5V
		2	TX
		3	GND
		4	RX

3.2.5 RS485 Bus Connector

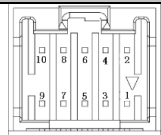
BUS		Pin	CANopen
485_IN / OUT		1	RS485+
		3	RS485-
		5	GND
		other	NC

3.2.5 STO Connector

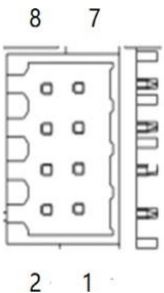
STO	Pin	Signal	IO	Detail
	1	5V	/	When the drive is not using the STO function, pins 1 and 2 are used to short the positive and negative terminals of SF1 and SF2 respectively. Caution: Pins 1 and 2 cannot be used to supply power to other devices.
	2	GND	/	
	3	SF 1+	input	When using the function, connect this pin in a way so that the photocoupler of this input circuit turns off to activate STO function.
	4	SF 1-	input	
	5	SF 2+	input	When using the function, connect this pin in a way so that the photocoupler of this input circuit turns off to activate STO function.
	6	SF 2-	input	
	7	EDM+	output	Outputs monitor signal that is used to check the safety function. Caution: This output signal is not a safety output.
	8	EDM-	output	

3.2.7 RS485 Node-ID and Baud rate switch

RS485 Node-ID:

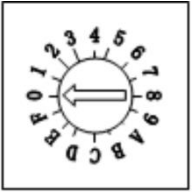
		NO	485 Slave ID	NO	485 Slave ID
RCS-1 RCS-2 	0		Pr5.31 Default=16	8	8
	1		1	9	9
	2		2	A	10
	3		3	B	11
	4		4	C	12
	5		5	D	13
	6		6	E	14
	;7		7	F	15

Note : If switch S1=0, then Pr5.31 is valid.
 If switch S1=1~F, S1 is valid in higher priority than Pr5.31

Baud rate switch :

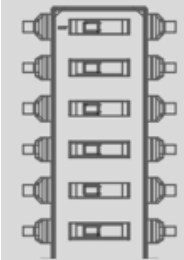
	RS485 Baud rate	SW3	SW4
	Pr5.30 Default =9600	off	off
	19200	on	off
	38400	off	on
	57600	on	on

SW1 : High bit of 485_ID1

SW1=off, High Bit =0
 SW1=on, High Bit =1

SW2 : High bit of 485_ID2

SW2=off, High Bit =0
 SW2=on, High Bit =1

SW5 : Reserved	SW6 : RS485 terminal resistor SW6=off, disconnect the terminal resistor SW6=on, connect the terminal resistor
-----------------------	--

3.3 I/O Interface Principle

3.3.1 Digital Input Interface

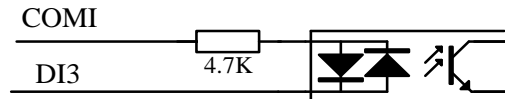

Figure 3-2 Digital Input Interface

- (1) The user provide power supply, DC12-24V, current \geq 100mA
- (2) **Notice:** if the polar of current is connected reversely, servo driver doesn't run.

3.3.2 Digital Output Interface

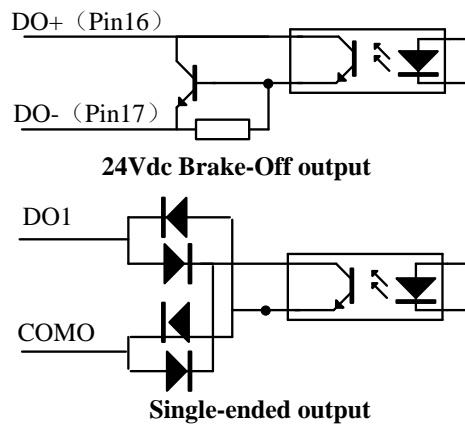

Figure 3-3 Switch Output Interface

- (1) 2 digital single-ended outputs DO1~DO2, both NPN and PNP connection are supported, recommend 24V output signal.
- (2) If the load is inductive load , for example ,relays, etc., there must be anti-parallel freewheeling diode across the load. If the freewheeling diode is connected reversely, the servo drive is damaged.

3.3.3 Pulse Input Interface

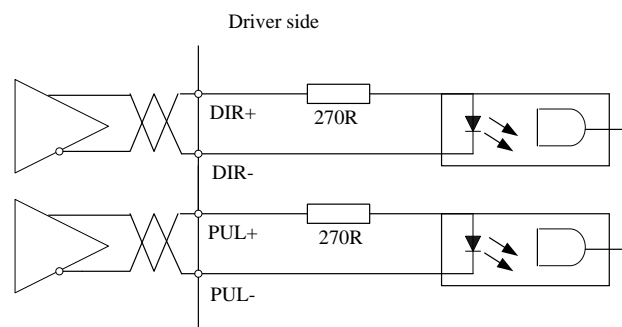
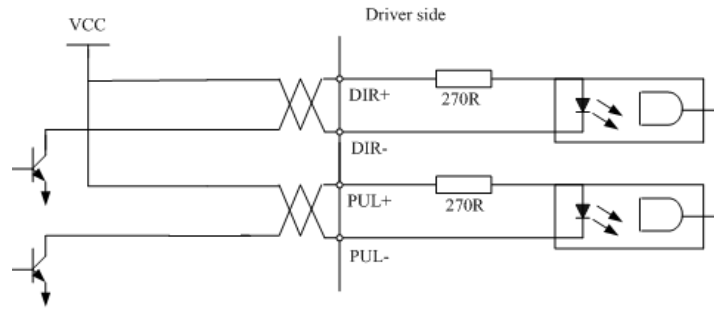
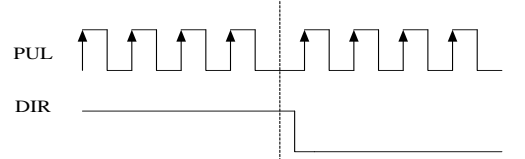
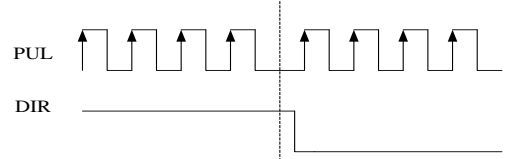

Figure 3-4 Pulse Input Interface Differential Drive Mode

Figure3-5 Pulse Input Interface Single Terminal Drive Mode

- (1) In order to transmit pulse data properly , we recommend using the differential drive mode.
- (2) The differential drive mode, AM26LS31, MC3487 or similar RS422 line drive.
- (3) Using of single-ended drive will cause reduction of the operation frequency.
- (4) The user provide external power supply for single-ended drive. However, if current polarity connect reversely, servo driver is damaged.
- (5) The form of pulse input is the following form 3.3below, while the arrows indicates the count .

Table 3.3 Pulse Input Form

Pulse command form	CCW	CW	Parameter setting value
Pulse symbol			Pulse + direction

The form of pulse input timing parameter is the following form 3.4 below. The 4 times pulse frequency $\leq 500\text{kHz}$ if 2-phase input form is used.

Table 3.4 the parameters of pulse input time sequence

parameter	Differential drive input	Single-ended drive input
t_{ck}	$> 2\mu\text{s}$	$> 5\mu\text{s}$
t_h	$> 1\mu\text{s}$	$> 2.5\mu\text{s}$
t_l	$> 1\mu\text{s}$	$> 2.5\mu\text{s}$
t_{rh}	$< 0.2\mu\text{s}$	$< 0.3\mu\text{s}$
t_{rl}	$< 0.2\mu\text{s}$	$< 0.3\mu\text{s}$
t_s	$> 1\mu\text{s}$	$> 2.5\mu\text{s}$
t_{qck}	$> 8\mu\text{s}$	$> 10\mu\text{s}$
t_{qh}	$> 4\mu\text{s}$	$> 5\mu\text{s}$
t_{ql}	$> 4\mu\text{s}$	$> 5\mu\text{s}$
t_{qrh}	$< 0.2\mu\text{s}$	$< 0.3\mu\text{s}$
t_{qrl}	$< 0.2\mu\text{s}$	$< 0.3\mu\text{s}$
t_{qs}	$> 1\mu\text{s}$	$> 2.5\mu\text{s}$

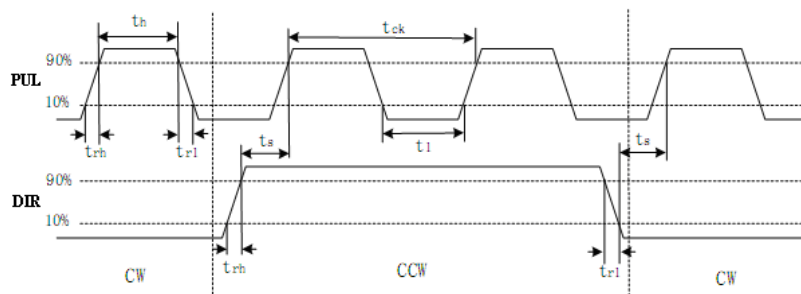
Figure 3.6 pulse + direction input interface timing (the maximum of pulse frequency : 500KHZ)

Chapter 4 Parameter

4.1 Parameter List

Notes: The parameters like Pr0.01*, which contain '*' means that the new value of this parameters will valid after power is restarted!

Parameter Number		Name	Default value	Repower	Mode			Communication		
Classify	NO				P	V	T	Data Type	Access	Add
【Class 0】 Basic setting	00	Model following control	1	—	√	—	—	16bit	R/W	0001H
	01	Control mode setup	0	√	√	√	√	16bit	R/W	0003H
	02	Real-time auto-gain tuning	2	—	√	√	√	16bit	R/W	0005H
	03	Selection of machine stiffness at real-time auto-gain tuning	70	—	√	√	√	16bit	R/W	0007H
	04	Inertia ratio	250	—	√	√	√	16bit	R/W	0009H
	06	Command pulse rotational direction setup	0	√	√	—	—	16bit	R/W	000DH
	07	Command pulse input mode setup	3	√	√	—	—	16bit	R/W	000FH
	08	Command pulse per one motor revolution	10000	√	√	—	—	32bit	R/W	0010H 0011H
	09	1st numerator of electronic gear	1	√	√	—	—	32bit	R/W	0012H 0013H
	10	Denominator of electronic gear	1	√	√	—	—	32bit	R/W	0014H 0015H
	11	Output pulse counts per one motor revolution	2500	√	√	√	√	16bit	R/W	0017H
	12	Reverse of pulse output logic	0	√	√	√	√	16bit	R/W	0019H
	13	1st torque limit	300	—	√	√	√	16bit	R/W	001BH
	14	Position deviation excess setup	200	—	√	—	—	16bit	R/W	001DH
	15	Absolute encoder setup	0	—	√	√	√	16bit	R/W	001FH
	16	External regenerative resistance value	100	—	√	√	√	16bit	R/W	0021H
	17	External regenerative resistance power value	50	—	√	√	√	16bit	R/W	0023H
25	Auxiliary function	0	—	√	√	√	16bit	R/W	0033H	

Parameter Number		Name	Default value	Repower	Mode			Communication		
Classify	NO				P	V	T	Data Type	Access	Address
【Class 1】 Gain Adjust	00	1st gain of position loop	320	—	√	—	—	16bit	R/W	0101H
	01	1st gain of velocity loop	180	—	√	√	√	16bit	R/W	0103H
	02	1st time constant of velocity loop integration	310	—	√	√	√	16bit	R/W	0105H
	03	1st filter of velocity detection	15	—	√	√	√	16bit	R/W	0107H
	04	1st time constant of torque filter	126	—	√	√	√	16bit	R/W	0109H
	05	2nd gain of position loop	380	—	√	—	—	16bit	R/W	010BH
	06	2nd gain of velocity loop	180	—	√	√	√	16bit	R/W	010DH

	07	2nd time constant of velocity loop integration	10000	—	✓	✓	✓	16bit	R/W	010FH
	08	2nd filter of velocity detection	15	—	✓	✓	✓	16bit	R/W	0111H
	09	2nd time constant of torque filter	126	—	✓	✓	✓	16bit	R/W	0113H
	10	Velocity feed forward gain	300	—	✓	—	—	16bit	R/W	0115H
	11	Velocity feed forward filter	50	—	✓	—	—	16bit	R/W	0117H
	12	Torque feed forward gain	0	—	✓	✓	—	16bit	R/W	0119H
	13	Torque feed forward filter	0	—	✓	✓	—	16bit	R/W	011BH
	15	Control switching mode	0	—	✓	--	—	16bit	R/W	011FH
	17	Control switching level	50	—	✓	—	—	16bit	R/W	0123H
	18	Control switch hysteresis	33	—	✓	—	—	16bit	R/W	0125H
	19	Gain switching time	33	—	✓	—	—	16bit	R/W	0127H
	35	Positional command filter setup	0	✓	✓	—	—	16bit	R/W	0147H
	36	Encoder feedback pulse digital filter setup	0	—	✓	✓	✓	16bit	R/W	0149H
	37	Special register	0	—	✓	✓	✓	16bit	R/W	014BH

Parameter Number		Name	Default value	Repower	Mode			Communication		
Classify	NO				P	V	T	Data Type	Access	Address
【Class 2】 Vibration Restrain Function	00	Adaptive filter mode setup	0	—	✓	✓	—	16bit	R/W	0201H
	01	1st notch frequency	2000	—	✓	✓	✓	16bit	R/W	0203H
	02	1st notch width selection	2	—	✓	✓	✓	16bit	R/W	0205H
	03	1st notch depth selection	0	—	✓	✓	✓	16bit	R/W	0207H
	04	2nd notch frequency	2000	—	✓	✓	✓	16bit	R/W	0209H
	05	2nd notch width selection	2	—	✓	✓	✓	16bit	R/W	020BH
	06	2nd notch depth selection	0	—	✓	✓	✓	16bit	R/W	020DH
	07	3rd notch frequency	2000	—	✓	✓	✓	16bit	R/W	020FH
	08	3rd notch width selection	2	—	✓	✓	✓	16bit	R/W	0211H
	09	3rd notch depth selection	0	—	✓	✓	✓	16bit	R/W	0213H
	14	1st damping frequency	0	—	✓	—	—	16bit	R/W	021DH
	16	2nd damping frequency	0	—	✓	—	—	16bit	R/W	0221H
	22	Positional command smooth filter	0	✓	✓	—	—	16bit	R/W	022DH
23	Positional command FIR filter	0	✓	✓	—	—	16bit	R/W	022FH	

Parameter Number		Name	Default value	Repower	Mode			Communication		
Classify	NO				P	V	T	Data Type	Access	Address
【Class 3】 Speed, Torque Control	00	Velocity setup internal /external switching	0	—	—	✓	—	16bit	R/W	0301H
	01	Speed command rotational direction selection	0	—	—	✓	—	16bit	R/W	0303H
	02	Input gain of speed command	500	—	—	✓	—	16bit	R/W	0305H
	03	Speed command reversal input	0	—	—	✓	—	16bit	R/W	0307H
	04	1st speed setup	0	—	—	✓	—	16bit	R/W	0309H
	05	2nd speed setup	0	—	—	✓	—	16bit	R/W	030BH

06	3rd speed setup	0	—	—	√	—	16bit	R/W	030DH
07	4th speed setup	0	—	—	√	—	16bit	R/W	030FH
08	5th speed setup	0	—	—	√	—	16bit	R/W	0311H
09	6th speed setup	0	—	—	√	—	16bit	R/W	0313H
10	7th speed setup	0	—	—	√	—	16bit	R/W	0315H
11	8th speed setup	0	—	—	√	—	16bit	R/W	0317H
12	time setup acceleration	100	—	—	√	—	16bit	R/W	0319H
13	time setup deceleration	100	—	—	√	—	16bit	R/W	031BH
14	Sigmoid acceleration /deceleration time setup	0	√	—	√	—	16bit	R/W	031DH
15	Speed zero-clamp function selection	0	—	—	√	—	16bit	R/W	031FH
16	Speed zero-clamp level	30	—	—	√	—	16bit	R/W	0321H
17	Torque command selection	0	—	—	—	√	16bit	R/W	0323H
18	Torque command direction selection	0	—	—	—	√	16bit	R/W	0325H
19	Torque command input gain	30	—	—	—	√	16bit	R/W	0327H
20	Torque command input reversal	0	—	—	—	√	16bit	R/W	0329H
21	Speed limit value 1	0	—	—	—	√	16bit	R/W	032BH
22	2nd torque limit	0	—	√	√	√	16bit	R/W	032DH
23	Speed mode stop time	0	—	—	√	—	16bit	R/W	032FH
24	Maximum speed of motor rotation	0	—	√	√	√	16bit	R/W	0331H

Parameter Number		Name	Default value	Repower	Mode			Communication		
Classify	NO				P	V	T	Data Type	Access	Address
【Class 4】 I/F Monitor Setting	00	input selection SI1	0	√	√	√	√	16bit	R/W	0401H
	01	input selection SI2	0	√	√	√	√	16bit	R/W	0403H
	02	input selection SI3	3	√	√	√	√	16bit	R/W	0405H
	03	input selection SI4	4	√	√	√	√	16bit	R/W	0407H
	04	input selection SI5	1	√	√	√	√	16bit	R/W	0409H
	05	input selection SI6	2	√	√	√	√	16bit	R/W	040BH
	10	output selection DO1	1	√	√	√	√	16bit	R/W	0415H
	11	output selection DO2	2	√	√	√	√	16bit	R/W	0417H
	12	output selection DO3	3	√	√	√	√	16bit	R/W	0419H
	31	Positioning complete range	10	—	√	—	—	16bit	R/W	043FH
	32	Positioning complete output setup	0	—	√	—	—	16bit	R/W	0441H
	33	INP hold time	0	—	√	—	—	16bit	R/W	0443H
	34	Zero-speed	50	—	√	√	√	16bit	R/W	0445H
	35	Speed coincidence range	50	—	—	√	—	16bit	R/W	0447H
	36	At-speed	1000	—	—	√	—	16bit	R/W	0449H
	37	Mechanical brake action setting when stopping	0	—	√	√	√	16bit	R/W	044BH
	38	Mechanical brake action setting	0	—	√	√	√	16bit	R/W	044DH
39	Brake release speed setup	30	—	√	√	√	16bit	R/W	044FH	
43	E-stop function active	0	—	√	√	√	16bit	R/W	0457H	

Parameter	Name	Default	Reower	Mode	Communication
-----------	------	---------	--------	------	---------------

Number			value					Data Type	Access	Address
Classify	NO				P	V	T			
【Class 5】 Extended Setup	00	2nd numerator of electronic gear	10000	√	√	—	—	32bit	R/W	0500H 0501H
	01	3rd numerator of electronic gear	1	√	√	—	—	32bit	R/W	0502H 0503H
	02	4th numerator of electronic gear	1	√	√	—	—	32bit	R/W	0504H 0505H
	04	Drive inhibit input setup	0	—	√	√	√	16bit	R/W	0509H
	06	Sequence at servo-off	0	—	√	√	√	16bit	R/W	050DH
	09	Main power off detection time	70	—	√	√	√	16bit	R/W	0513H
	10	Dynamic braking mode	0	√	√	√	√	16bit	R/W	0515H
	11	Torque setup for emergency stop	0	—	√	√	√	16bit	R/W	0517H
	12	Over-load level setup	0	—	√	√	√	16bit	R/W	0519H
	13	Over-speed level setup	0	—	√	√	√	16bit	R/W	051BH
	15	I/F reading filter	0	√	√	√	√	16bit	R/W	051FH
	17	Counter clear up input mode	3	—	√	—	—	16bit	R/W	0523H
	20	Position setup unit select	2	—	√	—	—	16bit	R/W	0529H
	21	Selection of torque limit	0	—	√	√	√	16bit	R/W	052BH
	22	2nd torque limit	300	—	√	√	√	16bit	R/W	052DH
	23	Torque limit switching setup 1	0	—	√	√	√	16bit	R/W	052FH
	24	Torque limit switching setup 2	0	—	√	√	√	16bit	R/W	0531H
	29	RS485 mode selection	21	—	√	√	√	16bit	R/W	053BH
30	RS485 baud rate setup	2	—	√	√	√	16bit	R/W	053DH	
31	RS485 slave ID	1	—	√	√	√	16bit	R/W	053FH	
32	Command pulse input maximum setup	0	—	√	—	—	16bit	R/W	0541H	

Parameter Number		Name	Default value	Repower	Mode			Communication		
Classify	NO				P	V	T	Data Type	Access	Address
【Class 6】 Special Setup	01	Encoder zero position compensation	0	√	√	√	√	16bit	R/W	0603H
	03	JOG trial run command torque	0	—	√	—	—	16bit	R/W	0607H
	04	JOG trial run command speed	400	—	√	—	—	16bit	R/W	0609H
	05	Position 3rd gain valid time	0	—	√	—	—	16bit	R/W	060BH
	06	Position 3rd gain scale factor	100	—	√	—	—	16bit	R/W	060DH
	07	Torque command additional value	0	—	√	√	√	16bit	R/W	060FH
	08	Positive direction torque compensation value	0	—	√	√	√	16bit	R/W	0611H
	09	Negative direction torque compensation value	0	—	√	√	√	16bit	R/W	0613H
	10	Function expansion setup	0	√	√	√	√	16bit	R/W	0615H
	11	Current response setup	100	—	√	√	√	16bit	R/W	0617H
	14	Emergency stop time at alarm	0	—	√	√	√	16bit	R/W	061DH
20	distance of trial running	10	—	√	—	—	16bit	R/W	0629H	

	21	waiting time of trial running	100	—	√	—	—	16bit	R/W	062BH
	22	cycling times of trial running	5	—	√	—	—	16bit	R/W	062DH
	25	Acceleration of trial running	200	—	√	—	—	16bit	R/W	0633H
	63	Position upper Limit of multi-turn ABS encoder	0	√	√	√	√	16bit	R/W	067FH

Parameter Number		Name	Default value	Repower	Mode			Communication		
Classify	NO				P	V	T	Data Type	Access	Address
【Class B】 Status Information	00	Software version 1 (DSP)		—	√	√	√	16bit	R	0B00H
	01	Software version 2 (CPLD)		—	√	√	√	16bit	R	0B01H
	02	Software version 3 (other)		—	√	√	√	16bit	R	0B02H
	03	Error code		—	√	√	√	16bit	R	0B03H
	04	Factor of no-motor running		—	√	√	√	16bit	R	0B04H
	05	Drive operating state		—	√	√	√	16bit	R	0B05H
	06	Actual velocity (unfiltered)			√	√	√	16bit	R	0B06H
	07	Actual torque feedback		—	√	√	√	16bit	R	0B07H
	08	Actual current feedback		—	√	√	√	16bit	R	0B08H
	09	Actual velocity(After filtering)		—	√	√	√	16bit	R	0B09H
	10	DC bus voltage		—	√	√	√	16bit	R	0B0AH
	11	Drive temperature		—	√	√	√	16bit	R	0B0BH
	15	Over-load ratio		—	√	√	√	16bit	R	0B0FH
	16	Regeneration load ratio		—	√	√	√	16bit	R	0B10H
	17	Digital input signal status		—	√	√	√	16bit	R	0B11H
	18	Digital output signal status		—	√	√	√	16bit	R	0B12H
	20	Motor position feedback (Command unit)		—	√	√	√	32bit	R	0B14H 0B15H
	21	Command pulse sum (Command unit)		—	√	-	-	32bit	R	0B16H 0B17H
22	Positional deviation (Command unit)		—	√	√	√	32bit	R	0B18H 0B19H	
23	Position command (Encoder unit)		—	√	√	√	32bit	R	0B1AH 0B1BH	
24	Motor position (encoder unit)		—	√	-	-	32bit	R	0B1CH 0B1DH	
25	Positional deviation (encoder unit)		—	√	√	√	32bit	R	0B1EH 0B1FH	
26	Position feedback in rotation mode(encoder unit)		—	√	-	-	32bit	R	0B20H 0B21H	

Notes:

(1) The "√" in the repower bar indicates that the new value is valid after restarting the power, and the "-" indicates that the new value is valid immediately;

(2) The "√" in the mode bar indicates this parameter is related to this mode, "—" indicates this parameter isn't related to this mode;

(3) 32bit data, high data in front, low data after.

4.2 Parameter Function

Here is the explanation of parameters, you can check them or modify the value using configuration software.
Contact tech@leadshine.com if you need more technical service .

4.2.1 【Class 0】 Basic Setting

Pr0.00	Name	Model following control			Mode	P	S	T
	Range	0-2000	Unit	0.1Hz	Default	1		
	Data Type	16bit	Access	R/W	Address	0001H		
	Repower	--						

Set up the bandwidth of MFC , it is similar to the response bandwidth

Setup value	Details
0	Disable the function.
1	Enable the function, set the bandwidth automatically, recommended for most application.
2-10	Forbidden and reserved.
11-20000	Set the bandwidth manually , 1.1Hz – 2000Hz

MFC is used to enhance the performance of dynamic tracing for input command, make positioning faster, cut down the tracking error, run more smooth and steady. It is very useful for multi-axis synchronous movement and interpolation, the performance will be better.

The main way to use this function :

- a. Choose the right control mode : Pr0.01 = 0
- b. Set up Pr0.02=1 for interpolation movement
- c. Set up the inertia of ratio : Pr0.04
- d. Set up the rigidity : Pr0.03
- e. Set up the Pr0.00 :
 - 1) If no multi-axis synchronous movement , set Pr0.00 as 1 or more than 10 ;
 - 2) If multi-axis synchronous movement needed, set Pr0.00 as the same for all the axes.
 - 3) If Pr0.00 is more than 10, start with 100, or 150, 200, 250

Caution:

1. Set up the right control mode, the right inertia of ratio and rigidity firstly.
2. Don't change the value of Pr0.00 when the motor is running , otherwise vibration occurs

Set up a small value from the beginning if using it in manual mode , smaller value means running more smooth and steady , while bigger one means faster positioning

Pr0.01*	Name	Control Mode Setup			Mode	P	S	T
	Range	0~10	Unit	—	Default	0		
	Data Type	16bit	Access	R/W	Address	0003H		
	Repower	√						

Control mode:

Setup value	Content	
	1st mode	2nd mode
0	Position/ Pr-Mode	-
1	Velocity	-
2	Torque	-
3	Position	Velocity
4	Position	Torque
5	Velocity	Torque

When you set up the combination mode of 3.4.5, you can select either the 1st or the 2nd with control mode switching input(C-MODE). When C-MODE is off, the 1st mode will be selected. When C-MODE is on, the 2nd mode will be selected.

Pr0.02	Name	Real-time Auto-gain Tuning			Mode	P	S	T
	Range	0~2	Unit	—	Default	0		
	Data Type	16bit	Access	R/W	Address	0005H		
	Repower	-						

You can set up the action mode of the real-time auto-gain tuning:

Setup value	mode	Varying degree of load inertia in motion
0	invalid	Real-time auto-gain tuning function is disabled.
1	standard	Basic mode. do not use unbalanced load, friction compensation or gain switching. It is usually for interpolation movement.
2	positioning	Main application is positioning. it is recommended to use this mode on equipment without unbalanced horizontal axis, ball screw driving equipment with low friction, etc. it is usually for point-to-point movement .

Caution: If pr0.02=1 or 2 , you can't modify the values of Pr1.01 – Pr1.13, the values of them depend on the real-time auto-gain tuning ,all of them are set by the drive itself

For **Standard** mode (Pr0.02=1), it is usually for interpolation movement. It is unavailable to modify the value of Pr1.00- 1.14, just need to change the value of Pr0.03 , then all values of Pr1.00-1.14 will be changed accordingly .

For **Positioning** mode (Pr0.02=2), it is usually for point to point movement. It is unavailable to modify the value of Pr1.00- 1.14, just change the value of Pr0.03 ,then all values of Pr1.00-1.14 will be changed

Pr0.03	Name	Selection of machine stiffness at real- time auto-gain tuning			Mode	P	S	T
	Range	50 -81	Unit	—	Default	70		
	Data Type	16bit	Access	R/W	Address	0007H		
	Repower	-						

You can set up response while the real-time auto-gain tuning is valid.

Low ———▶ Machine stiffness ———▶ High

Low ———▶ Servo gain ———▶ High

81.80.....70.69.68.....51.50

Low ———▶ Response ———▶ High

Notice: Lower the setup value, higher the velocity response and servo stiffness will be obtained. However, when decreasing the value, check the resulting operation to avoid oscillation or vibration. Control gain is updated while the motor is stopped. If the motor can't be stopped due to excessively low gain or continuous application of one-way direction command, any change made to Pr0.03 is not used for update. If the changed stiffness setting is made valid after the motor stopped, abnormal sound or oscillation will be generated. To prevent this problem, stop the motor after changing the stiffness setting and check that the changed setting is enabled.

Pr0.04	Name	Inertia ratio			Mode	P	S	T
	Range	0~10000	Unit	%	Default	250		
	Data Type	16bit	Access	R/W	Address	0009H		
	Repower	-						

You can set up the ratio of the load inertia against the rotor(of the motor)inertia.

$$\text{Pr0.04} = (\text{load inertia} / \text{rotate inertia}) \times 100\%$$



Notice:

If the inertia ratio is correctly set, the setup unit of Pr1.01 and Pr1.06 becomes (Hz). When the inertia ratio of Pr0.04 is larger than the actual value, the setup unit of the velocity loop gain becomes larger, and when the inertia ratio of Pr0.04 is smaller than the actual value, the setup unit of the velocity loop gain becomes smaller.

Pr0.06*	Name	Command Pulse Rotational Direction Setup			Mode	P	
	Range	0~1	Unit	—	Default	0	
	Data Type	16bit	Access	R/W	Address	000DH	
	Repower	√					

Set command pulse input rotate direction, command pulse input type

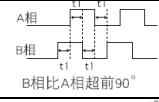
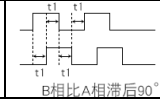
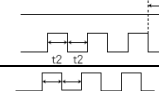
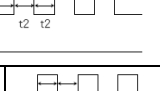
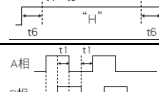
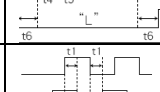
Pr0.07*	Name	Command Pulse Input Mode Setup			Mode	P	
	Range	0~3	Unit	—	Default	1	
	Data Type	16bit	Access	R/W	Address	000FH	
	Repower	√					

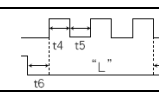
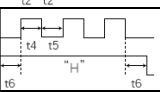
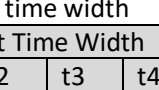
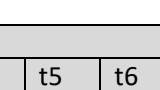
Pr0.06	Pr0.07	Command Pulse Format	Signal	Positive Direction Command	Negative Direction Command
0	0 or 2	90 phase difference 2-phase pulse(A phase +B phase)	Pulse sign		
	1	Positive direction pulse + negative direction pulse	Pulse sign		
	3	Pulse + sign	Pulse sign		
1	0 or 2	90 phase difference 2 phase pulse(A phase +B phase)	Pulse sign		
	1	Positive direction pulse + negative direction pulse	Pulse sign		
	3	Pulse + sign	Pulse sign		

Command pulse input signal allow largest frequency and smallest time width

PULS/SIGN Signal Input I/F		Permissible Max. Input Frequency	Smallest Time Width					
			t1	t2	t3	t4	t5	t6
Pulse series interface	Differential pulse signal	500kpps	2	1	1	1	1	1
	Single-ended pulse signal	200kpps	5	2.5	2.5	2.5	2.5	2.5

Pr0.08	Name	Command pulse counts per one motor revolution			Mode	P	S	T
	Range	0-8388608	Unit	P	Default	0		
	Data Type	32bit	Access	R/W	Address	0010H 0011H		
	Repower	√						

Set the command pulse that causes single turn of the motor shaft.

- 1) If Pr008≠0 , the actual motor rotation turns = pulse number / Pr008
- 2) If Pr008 = 0 , Pr0.09 1st numerator of electronic gear and Pr0.10 Denominator of electronic gear valid.

Pr0. 09	Name	1st numerator of electronic gear			Mode	P	
	Range	1~1073741824	Unit	—	Default	1	
	Data Type	32bit	Access	R/W	Address	0012H 0013H	
	Repower	√					

Set the numerator of division/multiplication operation made according to the command pulse input.

Pr0. 10	Name	1st denominator of electronic gear			Mode	P	
	Range	1~1073741824	Unit	—	Default	1	
	Data Type	32bit	Access	R/W	Address	0014H 0015H	
	Repower	√					

Set the denominator of division/multiplication operation made according to the command pulse input.

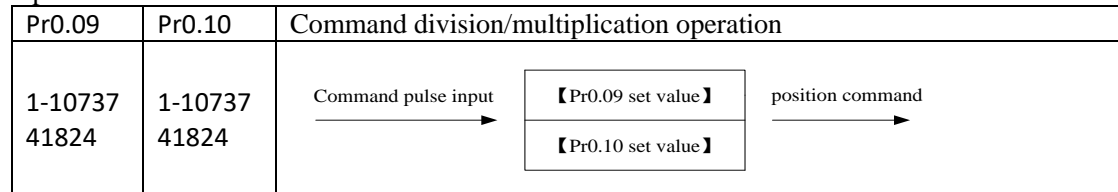

1. Settings:

- 1)The drive input command pulse number is X
- 2)The pulse number of encoder after frequency division and frequency doubling is Y
- 3)The number of pulses per revolution of the motor encoder is Z
- 4)Number of turns of motor is W

2. Calculations:

- 1)Y=X* Pr0.09 / Pr0.10
- 2)17Bit encoder: Z=2¹⁷ = 131072
- 23Bit encoder: Z=2²³ = 8388608

Pr0. 11 *	Name	Output pulse counts per one motor revolution			Mode	P	S	T
	Range	1~2500	Unit	P/r	Default	2500		
	Data Type	16bit	Access	R/W	Address	0017H		
	Repower	√						

For example, if this parameter is set to 1000, it means that the frequency division output signal of the encoder outputs 4000 pulses per turn.

Pr0. 12 *	Name	reversal of pulse output logic			Mode	P	S	T
	Range	0~1	Unit	—	Default	0		
	Data Type	16bit	Access	R/W	Address	0019H		
	Repower	√						

You can set up the B phase logic and the output source of the pulse output. With this parameter, you can reverse the phase relation between the A-phase pulse and B-phase pulse by reversing the B-phase logic.

< reversal of pulse output logic >

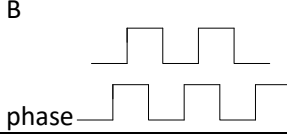
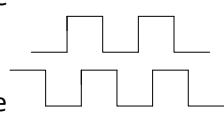
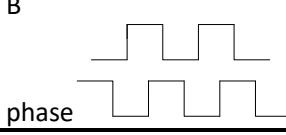
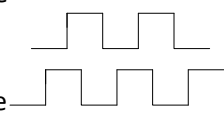
Pr0.12	B-phase Logic	CCW Direction Rotation	CW Direction Rotation
0	Non-Reversal	A phase B 	A phase B phase 
1	Reversal	A phase B 	A phase B phase 

Pr0.13	Name	1st Torque Limit			Mode	P	S	T
	Range	0~500	Unit	%	Default	300		
	Data Type	16bit	Access	R/W	Address	001BH		
	Repower	-						

You can set up the limit value of the motor output torque, as motor rate current %, the value can't exceed the maximum of output current.

Pr0.14	Name	Position Deviation Excess Setup			Mode	P		
	Range	0~500	Unit	0.1rev	Default	200		
	Data Type	16bit	Access	R/W	Address	001DH		
	Repower	-						

Set excess range of positional deviation by the command unit(default).Setting the value too small will cause Err18.0 (position deviation excess detection)

Pr0.15	Name	Absolute Encoder Setup			Mode	P	S	T
	Range	0~15	Unit		Default	0		
	Data Type	16bit	Access	R/W	Address	001FH		
	Repower	√						

0: Incremental position mode:

The encoder is used as a incremental encoder, and the position retentive at power failure is not supported.

1: Absolute position linear mode:

The encoder is used as an absolute encoder, and the position retentive at power failure is supported.

It is applicable to the scenario where the travel range of device load is fixed and the encoder multi-turn data dose not overflow.

2: Absolute position rotation mode:

The encoder is used as an absolute encoder, and the position retentive at power failure is supported..

It is mainly applicable to the scenario where the load travel range is not limited and the number of motor single-direction revolution is less than 0~(Pr6.63+1)

5: Clean multi-turn alarm, and open multi-turn absolute function.

It will become 1 when normal clearance, if it's still 5 after 3seconds, please deal with according to 153 alarm processing.

9: Clear multi-turn position and reset multi-turn alarm, open multi-turn absolute function.

It will become 1 when normal clearance, if it's still 9 after 3seconds, please deal with according to 153 alarm processing. Please remember to do mechanical homing.

Notes: Set to 9 after homing process finished and servo disabled, it is valid after repower.

Pr0.16	Name	External regenerative resistance value			Mode	P	S	T
	Range	10~50	Unit	Ω	Default	100		
	Data Type	16bit	Access	R/W	Address	0021H		
	Repower	-						
Set Pr.0.16 and Pr.0.17 to confirm the threshold value of the discharge loop to give alarm for over current.								

Pr0.17	Name	External regenerative resistance power value			Mode	P	S	T
	Range	0~10000	Unit	W	Default	20		
	Data Type	16bit	Access	R/W	Address	0023H		
	Repower	-						
Set Pr.0.16 and Pr.0.17 to confirm the threshold value of the discharge loop to give alarm for over current.								

Pr0.25	Name	Auxiliary function			Mode	P	S	T
	Range	0~0xFFFF	Unit		Default	0		
	Data Type	16bit	Access	R/W	Address	0033H		
	Repower	-						
	Value	Auxiliary function						
	0x1111	Reset current alarm						
	0x1122	Reset history alarm						
	0x2211	Save parameter to EEPROM						
	0x2222	Reset to factory setting except motor parameters						
	0x2233	Reset to factory setting						
	0X4001	JOG_Positive (50ms time period)						
	0X4002	JOG_Negative (50ms time period)						
	0x6666	Soft reset						

4.2.2 【Class 1】 Gain Adjust

Pr1.00	Name	1st gain of position loop			Mode	P		
	Range	0~30000	Unit	0.1/s	Default	320		
	Data Type	16bit	Access	R/W	Address	0101H		
	Repower	-						
You can determine the response of the positional control system. Higher the gain of position loop you set, faster the positioning time you can obtain. Note that too high setup may cause oscillation.								

Pr1.01	Name	1st gain of velocity loop			Mode	P	S	T
	Range	0~32767	Unit	0.1Hz	Default	180		
	Data Type	16bit	Access	R/W	Address	0103H		
	Repower	-						

This parameter is used to determine the response of the velocity loop.
 In order to increase the response of overall servo system by setting high position loop gain, you need higher setup of this velocity loop gain as well. However, too high setup may cause oscillation.

Pr1. 02	Name	1st Time Constant of Velocity Loop Integration			Mode	P	S	T
	Range	0~10000	Unit	0.1ms	Default	310		
	Data Type	16bit	Access	R/W	Address	0105H		
	Repower	-						

This parameter is used to set up the integration time constant of velocity loop, Smaller the setup value, faster you can dog-in deviation at stall to 0.The integration will be maintained by setting to"9999".The integration effect will be lost by setting to"10000".

Pr1. 03	Name	1st Filter of Velocity Detection			Mode	P	S	T
	Range	50~81	Unit	—	Default	70		
	Data Type	16bit	Access	R/W	Address	0107H		
	Repower	-						

You can set up the time constant of the low pass filter (LPF) after the speed detection, in 32 steps (0 to 31).Higher the setup, larger the time constant you can obtain so that you can decrease the motor noise, however, response becomes slow.

You can set the filter parameters through the loop gain, referring to the following table:

Setup Value	Speed Detection Filter Cut-off Frequency(Hz)	Setup Value	Speed Detection Filter Cut-off Frequency(Hz)
81	2500	65	750
80	2250	64	700
79	2100	63	650
78	2000	62	600
77	1800	61	550
76	1600	60	500
75	1500	59	450
74	1400	58	400
73	1300	57	350
72	1200	56	300
71	1100	55	250
70	1000	54	200
69	950	53	175
68	900	52	150
67	850	51	125
66	800	50	100

Pr1. 04	Name	1st Time Constant of torque filter			Mode	P	S	T
	Range	0~2500	Unit	0.01ms	Default	126		
	Data Type	16bit	Access	R/W	Address	0109H		
	Repower	-						

Pr1. 05	Name	2nd gain of position loop			Mode	P		
	Range	0~30000	Unit	0.1/s	Default	380		
	Data Type	16bit	Access	R/W	Address	010BH		
	Repower	-						

Pr1.06	Name	2nd gain of velocity loop			Mode	P	S	T
	Range	0~32767	Unit	0.1Hz	Default	180		
	Data Type	16bit	Access	R/W	Address	010DH		
	Repower	-						

Pr1.07	Name	2nd Time Constant of Velocity Loop Integration			Mode	P	S	T
	Range	0~10000	Unit	0.1ms	Default	10000		
	Data Type	16bit	Access	R/W	Address	010FH		
	Repower	-						

Pr1.08	Name	2nd Filter of Velocity Detection			Mode	P	S	T
	Range	0~31	Unit	—	Default	15		
	Data Type	16bit	Access	R/W	Address	0111H		
	Repower	-						

Pr1.09	Name	2nd Time Constant of torque filter			Mode	P	S	T
	Range	0~2500	Unit	0.01ms	Default	126		
	Data Type	16bit	Access	R/W	Address	0113H		
	Repower	-						

Position loop, velocity loop, velocity detection filter, torque command filter have their 2 pairs of gain or time constant(1st and 2nd).

Pr1.10	Name	Velocity feed forward gain			Mode	P		
	Range	0~1000	Unit	0.10%	Default	300		
	Data Type	16bit	Access	R/W	Address	0115H		
	Repower	-						

Multiply the velocity control command calculated according to the internal positional command by the ratio of this parameter and add the result to the speed command resulting from the positional control process.

Pr1.11	Name	Velocity feed forward filter			Mode	P		
	Range	0~6400	Unit	0.01ms	Default	50		
	Data Type	16bit	Access	R/W	Address	0117H		
	Repower	-						

Set the time constant of 1st delay filter which affects the input of speed feed forward.

(usage example of velocity feed forward)

The velocity feed forward will become effective as the velocity feed forward gain is gradually increased with the speed feed forward filter set at approx.50 (0.5ms). The positional deviation during operation at a constant speed is reduced as shown in the equation below in proportion to the value of velocity feed forward gain.

$$\text{Position deviation [unit of command]} = \text{command speed [unit of command /s]} / \text{position loop gain[1/s]} \times (100 - \text{speed feed forward gain}[\%]) / 100$$

Pr1.12	Name	Torque feed forward gain			Mode	P	S	
	Range	0~1000	Unit	0.1%	Default	0		

	Data Type	16bit	Access	R/W	Address	0119H
	Repower	-				
<ul style="list-style-type: none"> ● Multiply the torque control command calculated according to the velocity control command by the ratio of this parameter and add the result to the torque command resulting from the velocity control process. ● To use torque feed forward, correctly set ratio of inertia. Set the inertia ratio that can be calculated from the machine specification to Pr0.04 inertia ratio. ● Positional deviation at a constant acceleration/deceleration can be minimized close to 0 by increasing the torque forward gain .this means that positional deviation can be maintained at near 0 over entire operation range while driving in trapezoidal speed pattern under ideal condition where disturbance torque is not active. 						

Pr1.13	Name	Torque feed forward filter			Mode	P	S
	Range	0~6400	Unit	0.01ms	Default	0	
	Data Type	16bit	Access	R/W	Address	011BH	
	Repower	-					
Set up the time constant of 1st delay filter which affects the input of torque feed forward. zero positional deviation is impossible in actual situation because of disturbance torque. as with the velocity feed forward, large torque feed forward filter time constant decreases the operating noise but increases positional deviation at acceleration change point.							

Pr1.15	Name	Mode of position control switching			Mode	P	
	Range	0~10	Unit	—	Default	0	
	Data Type	16bit	Access	R/W	Address	011FH	
	Repower	-					

Setup value	Switching condition	Gain switching condition
0	Fixed to 1st gain	Fixed to the 1st gain (Pr1.00-Pr1.04)
1	Fixed to 2nd gain	Fixed to the 2nd gain (Pr1.05-Pr1.09)
2	with gain switching input	<ul style="list-style-type: none"> ● 1st gain when the gain switching input is open. ● 2nd gain when the gain switching input is connected to com- . ◇ If no input signal is allocated to the gain switching input, the 1st gain is fixed.
3	Torque command is large	<ul style="list-style-type: none"> ● Shift to the 2nd gain when the absolute value of the torque command exceeded (level + hysteresis)[%]previously with the 1st gain. ● Return to the 1st gain when the absolute value of the torque command was kept below (level + hysteresis) [%]previously during delay time with the 2nd gain.
4-9	reserved	reserved
10	Have position command +actual speed	<ul style="list-style-type: none"> ● Valid for position control. ● Shift to the 2nd gain when the positional command was not 0 previously with the 1st gain. ● Return to the 1st gain when the positional command was kept at 0 during the delay time and the absolute value of actual speed was kept below (level - hysteresis) (r/min) previously with the 2nd gain.

Pr1.17	Name	Level of position control switching			Mode	P	
	Range	0~20000	Unit	Mode specific	Default	50	
	Data Type	16bit	Access	R/W	Address	0123H	
	Repower	-					
Unit of setting varies with switching mode. switching condition: position :encoder pulse number ; speed : r/min ; torque : % . Notice: set the level equal to or higher than the hysteresis.							

Pr1. 18	Name	Hysteresis at position control switching			Mode	P	
	Range	0~20000	Unit	Mode specific	Default	33	
	Data Type	16bit	Access	R/W	Address	0125H	
	Repower	-					
Combining Pr1.17(control switching level)setup Notice: when level< hysteresis, the hysteresis is internally adjusted so that it is equal to level.							

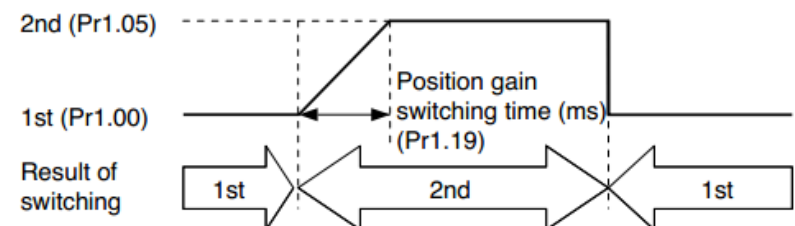
Pr1. 19	Name	position gain switching time			Mode	P	
	Range	0~10000	Unit	0.1ms	Default	33	
	Data Type	16bit	Access	R/W	Address	0127H	
	Repower	-					
For position controlling: if the difference between 1st gain and 2nd gain is large, the increasing rate of position loop gain can be limited by this parameter. <Position gain switching time> Notice: when using position control, position loop gain rapidly changes, causing torque change and vibration. By adjusting Pr1.19 position gain switching time, increasing rate of the position loop gain can be decreased and variation level can be reduced. Example: 1st (pr1.00) <-> 2nd (Pr1.05)							
							

Pr1. 35*	Name	positional command filter setup			Mode	P	
	Range	0~200	Unit	0.05us	Default	0	
	Data Type	16bit	Access	R/W	Address	0147H	
	Repower	-					
Do filtering for positional command pulse, eliminate the interference of the narrow pulse, over-large setup will influence the input of high frequency positional command pulse, and make more time-delayed.							

Pr1. 37	Name	Special register			Mode	P	S	T
	Range	0~32767	Unit	-	Default	0		
	Data Type	16bit	Access	R/W	Address	014BH		
	Repower	-						
Under binary, these bits in register are used for some function operation. Bit2=1, shield the speed out of control alarm (1A1) Bit4=1, shield the over-load alarm 100,101 Bit6=1, shield the excessive vibration alarm 190 Bit7=1, shield the braking resistor over-load alarm 120 Bit9=1, shield the lacking of phase alarm0dl (other bits are forbidden to use, default 0) For example : Pr137 = 4 can be used to shield alarm code 1A1								

Pr137 = 64 can be used to shield alarm code 190
 Pr137 =68 can be used to shield both 1A1 and 190.

4.2.3 【Class 2】Vibration Suppression

Pr2. 00	Name	Adaptive filter mode setup			Mode	P	S	
	Range	0~4	Unit	—	Default	0		
	Data Type	16bit	Access	R/W	Address	0201H		
	Repower	-						
Set up the resonance frequency to be estimated by the adaptive filter and the special the operation after estimation.								
Setup value		Details						
0	Adaptive filter: invalid	Parameters related to the 3rd and 4th notch filter hold the current value.						
1	Adaptive filter, 1 filter is valid, one time	One adaptive filter is valid, parameters related to the 3rd notch filter will be updated based on adaptive performance. After updated, Pr2.00 returns to 0, stop self-adaptation.						
2	Adaptive filter, 1 filter is valid, It will be valid all the time	One adaptive filter is valid, parameters related to the 3rd notch filter will be updated all the time based on adaptive performance.						
3-4	Not use	Non-professional forbidden to use						

Pr2. 01	Name	1st notch frequency			Mode	P	S	T
	Range	50~2000	Unit	Hz	Default	2000		
	Data Type	16bit	Access	R/W	Address	0203H		
	Repower	-						

Set the center frequency of the 1st notch filter
Notice: the notch filter function will be invalid by setting up this parameter to “2000”.

Pr2. 02	Name	1st notch width selection			Mode	P	S	T
	Range	0~20	Unit	—	Default	2		
	Data Type	16bit	Access	R/W	Address	0205H		
	Repower	-						

Set the width of notch at the center frequency of the 1st notch filter.
Notice: Higher the setup, larger the notch width you can obtain. Use with default setup in normal operation.

Pr2. 03	Name	1st notch depth selection			Mode	P	S	T
	Range	0~99	Unit	—	Default	0		
	Data Type	16bit	Access	R/W	Address	0207H		
	Repower	-						

Set the depth of notch at the center frequency of the 1st notch filter.
Notice: Higher the setup, shallower the notch depth and smaller the phase delay you can obtain.

Pr2. 04	Name	2nd notch frequency			Mode	P	S	T
	Range	50~2000	Unit	Hz	Default	2000		
	Data Type	16bit	Access	R/W	Address	0209H		

	Repower	-				
Set the center frequency of the 2nd notch filter Notice: the notch filter function will be invalid by setting up this parameter to “2000”.						
Pr2. 05	Name	2nd notch width selection			Mode	P S T
	Range	0~20	Unit	—	Default	2
	Data Type	16bit	Access	R/W	Address	020BH
	Repower	-				
Set the width of notch at the center frequency of the 2nd notch filter. Notice: Higher the setup, larger the notch width you can obtain. Use with default setup in normal operation.						
Pr2. 06	Name	2nd notch depth selection			Mode	P S T
	Range	0~99	Unit	—	Default	0
	Data Type	16bit	Access	R/W	Address	020DH
	Repower	-				
Set the depth of notch at the center frequency of the 2nd notch filter. Notice: Higher the setup, shallower the notch depth and smaller the phase delay you can obtain.						
Pr2. 07	Name	3rd notch frequency			Mode	P S T
	Range	50~2000	Unit	Hz	Default	2000
	Data Type	16bit	Access	R/W	Address	020FH
	Repower	-				
Set the center frequency of the 3rd notch filter Notice: the notch filter function will be invalid by setting up this parameter to “2000”.						
Pr2. 08	Name	3rd notch width selection			Mode	P S T
	Range	0~20	Unit	—	Default	2
	Data Type	16bit	Access	R/W	Address	0211H
	Repower	-				
Set the width of notch at the center frequency of the 3rd notch filter. Notice: Higher the setup, larger the notch width you can obtain. Use with default setup in normal operation.						
Pr2. 09	Name	3rd notch depth selection			Mode	P S T
	Range	0~99	Unit	—	Default	0
	Data Type	16bit	Access	R/W	Address	0213H
	Repower	-				
Set the depth of notch at the center frequency of the 3rd notch filter. Notice: Higher the setup, shallower the notch depth and smaller the phase delay you can obtain.						
Pr2. 14*	Name	1st damping frequency			Mode	P
	Range	10~2000	Unit	0.1HZ	Default	0
	Data Type	16bit	Access	R/W	Address	021DH
	Repower	-				
0: close Setup damping frequency, to suppress vibration at the load edge.						
Pr2. 16*	Name	2nd damping frequency			Mode	P
	Range	10~2000	Unit	0.1HZ	Default	0

	Data Type	16bit	Access	R/W	Address	0221H
	Repower	-				
0: close Setup damping frequency, to suppress vibration at the load edge						

Pr2.22	Name	Positional command smoothing filter			Mode	P
	Range	0~32767	Unit	0.1ms	Default	0
	Data Type	16bit	Access	R/W	Address	022DH
	Repower	0				

- Set up the time constant of the 1st delay filter in response to the positional command.
- When a square wave command for the target speed V_c is applied, set up the time constant of the 1st delay filter as shown in the figure below

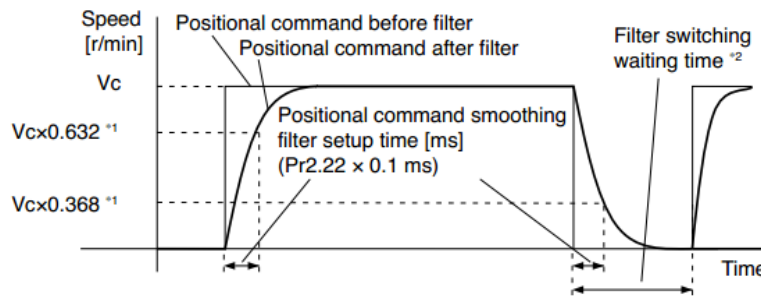

Pr2.23	Name	positional command FIR filter			Mode	P
	Range	0~10000	Unit	0.1ms	Default	0
	Data Type	16bit	Access	R/W	Address	022FH
	Repower	0				

- Set up the time constant of the 1st delay filter in response to the positional command.
- When a square wave command for the target speed V_c is applied, set up the V_c arrival time as shown in the figure below.

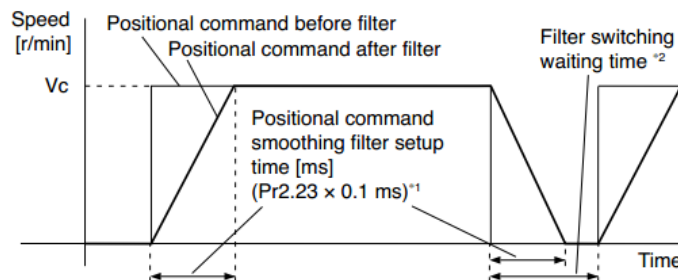

4.2.4 【Class 3】 Velocity/ Torque Control

Pr3.00	Name	Speed setup, Internal /External switching			Mode	S
	Range	0~3	Unit	—	Default	0
	Data Type	16bit	Access	R/W	Address	0301H
	Repower	-				

This drive is equipped with internal speed setup function so that you can control the speed with contact inputs only.

Setup value	Speed setup method
1	Internal speed command 1st to 4th speed(Pr3.04-Pr3.07)
2	Internal speed command 1st to 3rd speed (Pr3.04-Pr3.06), Analog speed command(SCR)
3	Internal speed command 1st to 8th speed (Pr3.04-Pr3.11)

<relationship between Pr3.00 Internal/External switching speed setup and the internal command speed selection 1-3 and speed command to be selected>

Setup value	1 st selection of internal command speed (INTSPD1)	2 nd selection of internal command speed (INTSPD2)	3 rd selection of internal command speed (INTSPD3)	selection of Speed command
1	OFF	OFF	NO effect	1st speed
	ON	OFF		2nd speed
	OFF	ON		3rd speed
	ON	ON		4th speed
2	OFF	OFF	NO effect	1st speed
	ON	OFF		2nd speed
	OFF	ON		3rd speed
	ON	ON		Analog speed command
3	The same as [Pr3.00=1]		OFF	1st to 4th speed
	OFF	OFF	ON	5th speed
	ON	OFF	ON	6th speed
	OFF	ON	ON	7th speed
	ON	ON	ON	8th speed

Pr3. 01	Name	Speed command rotational direction selection			Mode	S
	Range	0~1	Unit	—	Default	0
	Data Type	16bit	Access	R/W	Address	0303H
	Repower	-				
Select the Positive /Negative direction specifying method						
	Setup value	Velocity value	Velocity command signal(VC-SIGN)	Velocity command direction		
	0	+	No effect	Positive direction		
		-	No effect	Negative direction		
	1	No effect	OFF	Positive direction		
		No effect	ON	Negative direction		

Pr3. 02	Name	Input gain of speed command			Mode	S
	Range	10~2000	Unit	(r/min)/V	Default	500
	Data Type	16bit	Access	R/W	Address	0305H
	Repower	-				

Based on the voltage applied to the analog speed command (SPR), set up the conversion gain to motor command speed.

You can set up “slope” of relation between the command input voltage and motor speed, with Pr3.02. Default is set to Pr3.02=500(r/min)/V, hence input of 6V becomes 3000r/min.

Notice:

1. Do not apply more than $\pm 10V$ to the speed command input (SPR).
2. When you compose a position loop outside of the drive while you use the drive in velocity control mode, the setup of Pr3.02 gives larger variance to the overall servo system.
3. Pay an extra attention to oscillation caused by larger setup of Pr3.02

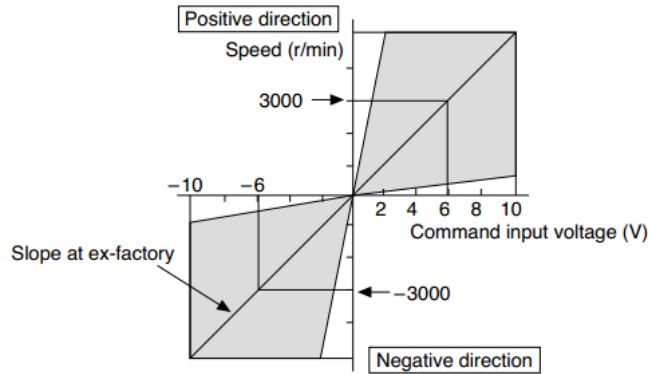

Pr3.03	Name	Reversal of speed command input			Mode	<input checked="" type="checkbox"/> S
	Range	0~1	Unit	—	Default	1
	Data Type	16bit	Access	R/W	Address	0307H
	Repower	-				
Specify the polarity of the voltage applied to the analog speed command (SPR).						
Setup value		Motor rotating direction				
0	Standard	[+ voltage] → [+ direction] \ [- voltage] → [-direction]				
1	Reversed	[+ voltage] → [- direction] \ [- voltage] → [+direction]				
<p>Caution: When you compose the servo drive system with this drive set to velocity control mode and external positioning unit, the motor might perform an abnormal action if the polarity of the speed command signal from the unit and the polarity of this parameter setup does not match.</p>						

Pr3.04	Name	1st speed of speed setup			Mode	<input checked="" type="checkbox"/> S
	Range	-10000~10000	Unit	r/min	Default	0
	Data Type	16bit	Access	R/W	Address	0309H
	Repower	-				
Pr3.05	Name	2nd speed of speed setup			Mode	<input checked="" type="checkbox"/> S
	Range	-10000~10000	Unit	r/min	Default	0
	Data Type	16bit	Access	R/W	Address	030BH
	Repower	-				
Pr3.06	Name	3rd speed of speed setup			Mode	<input checked="" type="checkbox"/> S
	Range	-10000~10000	Unit	r/min	Default	0
	Data Type	16bit	Access	R/W	Address	030DH
	Repower	-				
Pr3.07	Name	4th speed of speed setup			Mode	<input checked="" type="checkbox"/> S
	Range	-10000~10000	Unit	r/min	Default	0

	Data Type	16bit	Access	R/W	Address	030FH
	Repower	-				
Pr3. 08	Name	5th speed of speed setup			Mode	<input type="checkbox"/> S
	Range	-10000~10000	Unit	r/min	Default	0
	Data Type	16bit	Access	R/W	Address	0311H
	Repower	-				
Pr3. 09	Name	6th speed of speed setup			Mode	<input type="checkbox"/> S
	Range	-10000~10000	Unit	r/min	Default	0
	Data Type	16bit	Access	R/W	Address	0313H
	Repower	-				
Pr3. 10	Name	7th speed of speed setup			Mode	<input type="checkbox"/> S
	Range	-10000~10000	Unit	r/min	Default	0
	Data Type	16bit	Access	R/W	Address	0315H
	Repower	-				
Pr3. 11	Name	8th speed of speed setup			Mode	<input type="checkbox"/> S
	Range	-10000~10000	Unit	r/min	Default	0
	Data Type	16bit	Access	R/W	Address	0317H
	Repower	-				
Set up internal command speeds, 1st to 8th						

Pr3. 12	Name	time setup acceleration			Mode	<input type="checkbox"/> S
	Range	0~10000	Unit	Ms/(1000r/min)	Default	100
	Data Type	16bit	Access	R/W	Address	0319H
	Repower	-				
Pr3. 13	Name	time setup deceleration			Mode	<input type="checkbox"/> S
	Range	0~10000	Unit	Ms/(1000r/min)	Default	100
	Data Type	16bit	Access	R/W	Address	031BH
	Repower	-				

Set up acceleration/deceleration processing time in response to the speed command input. Set the time required for the speed command(stepwise input)to reach 1000r/min to Pr3.12 Acceleration time setup. Also set the time required for the speed command to reach from 1000r/min to 0 r/min, to Pr3.13 Deceleration time setup.

Assuming that the target value of the speed command is V_c (r/min), the time required for acceleration/deceleration can be computed from the formula shown below.

$$\text{Acceleration time (ms)} = V_c / 1000 * \text{Pr3.12} * 1\text{ms}$$

$$\text{Deceleration time (ms)} = V_c / 1000 * \text{Pr3.13} * 1\text{ms}$$

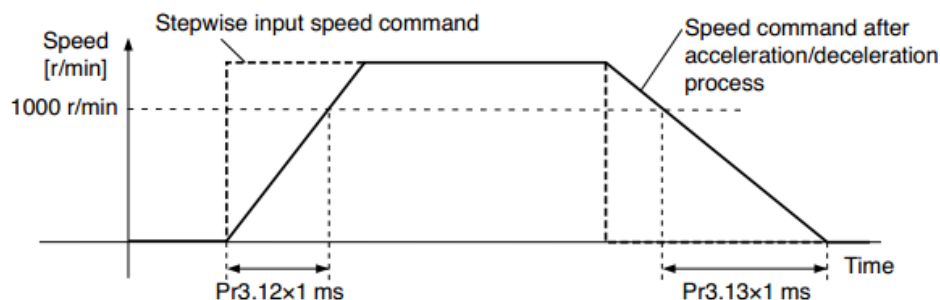

Pr3. 14	Name	Sigmoid acceleration /deceleration time setup			Mode	S
	Range	0~1000	Unit	ms	Default	0
	Data Type	16bit	Access	R/W	Address	031DH
	Repower	√				

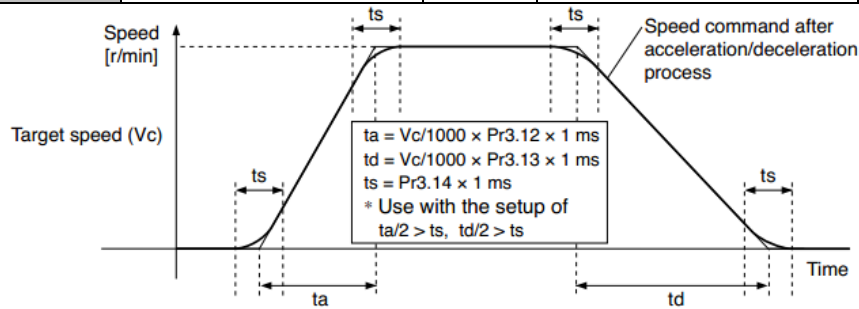

Set S-curve time for acceleration/deceleration process when the speed command is applied. According to Pr3.12 Acceleration time setup and Pr3.13 Deceleration time setup, set up sigmoid time with time width centering the inflection point of acceleration/deceleration.

Pr3. 15	Name	Speed zero-clamp function selection			Mode	S
	Range	0~3	Unit	0.1HZ	Default	0
	Data Type	16bit	Access	R/W	Address	031FH
	Repower	-				

- If Pr3.15=0, the function of zero clamp is forbidden. It means the motor rotates with actual velocity which is controlled by the analog voltage input 1 even if the velocity is less than 10 rpm. The motor runs no matter what the value of Pr3.16 is. The actual velocity is controlled by external the analog voltage input .
- If Pr3.15=1 and the input signal of Zero Speed is available in the same time, the function of zero clamp works. It means motor will stop rotating in servo-on condition no matter what the velocity of motor is, and motor stop rotating no matter what the value of Pr3.16 is.
- If Pr3.15=2 , the function of zero clamp belongs to the value of Pr3.16. If the actual velocity is less than the value of Pr3.16, the motor will stop rotating in servo-on condition.

Pr3. 16	Name	Speed zero-clamp level			Mode	S
	Range	10~2000	Unit	r/min	Default	30
	Data Type	16bit	Access	R/W	Address	0321H
	Repower	-				

When analog speed given value under speed control mode less than zero speed clamp level setup, speed command will set to 0 strongly.

Pr3. 18	Name	Torque command direction selection			Mode	T
	Range	0~1	Unit	—	Default	0
	Data Type	16bit	Access	R/W	Address	0325H
	Repower	-				

Select the direction positive/negative direction of torque command

Setup value	Details
0	Specify the direction with the sign of torque command Torque command input[+] → positive direction, [-] → negative direction
1	Specify the direction with torque command sign(TC-SIGN). OFF: positive direction ON: negative direction

Pr3. 20	Name	Torque command input reversal			Mode			T
	Range	0~1	Unit	—	Default	0		
	Data Type	16bit	Access	R/W	Address	0329H		
	Repower	-						
Set up the polarity of the voltage applied to the analog torque command(TRQR).								
		Setup value	Direction of motor output torque					
		0	Non-reversal	[+ voltage] →	[+ direction]	[- voltage] →	[- direction]	
		1	reversal	[+ voltage] →	[- direction]	[- voltage] →	[+direction]	

Pr3. 21	Name	Speed limit value 1			Mode			T
	Range	0~10000	Unit	r/min	Default	0		
	Data Type	16bit	Access	R/W	Address	032BH		
	Repower	-						
Set up the speed limit used for torque control. During the torque controlling, the speed set by the speed limit cannot be exceeded.								

Pr3. 22	Name	Torque command			Mode			T
	Range	0~300	Unit	%	Default	0		
	Data Type	16bit	Access	R/W	Address	032DH		
	Repower	-						
Set up torque limit value in torque mode control.								

Pr3. 24 *	Name	Motor rotate maximum speed limit			Mode	P	S	T
	Range	0~10000	Unit	r/min	Default	3000		
	Data Type	16bit	Access	R/W	Address	0331H		
	Repower	-						
Set up motor running max rotate speed, but can't be exceeded motor allowed max rotate speed.								

4.2.5 **【Class 4】 I/F Monitor Setting**

Pr4. 00 *	Name	Input selection DI1			Mode	P	S	T
	Range	0~00FFFFFFh	Unit	—	Default	0		
	Data Type	16bit	Access	R/W	Address	0401H		
	Repower	√						
Pr4. 01 *	Name	Input selection DI2			Mode	P	S	T
	Range	0~00FFFFFFh	Unit	—	Default	0		
	Data Type	16bit	Access	R/W	Address	0403H		
	Repower	√						
Pr4. 02 *	Name	Input selection DI3			Mode	P	S	T
	Range	0~00FFFFFFh	Unit	—	Default	3		
	Data Type	16bit	Access	R/W	Address	0405H		
	Repower	√						

Pr4.03 *	Name	Input selection DI4			Mode	P	S	T
	Range	0~00FFFFFFh	Unit	—	Default	4		
	Data Type	16bit	Access	R/W	Address	0207H		
	Repower	√						
Pr4.04 *	Name	Input selection DI5			Mode	P	S	T
	Range	0~00FFFFFFh	Unit	—	Default	1		
	Data Type	16bit	Access	R/W	Address	0409H		
	Repower	√						
Pr4.05 *	Name	Input selection DI6			Mode	P	S	T
	Range	0~00FFFFFFh	Unit	—	Default	2		
	Data Type	16bit	Access	R/W	Address	040BH		
	Repower	√						

Set digital DI input function allocation.

This parameter use 16 binary system to set up the values,

For the function number, please refer to the following Figure.

Signal name	Symbol	Setup value	
		Normally open	Normally closed
Invalid	-	00h	Do not setup
Positive direction over-travel inhibition	POT	01h	81h
Negative direction over-travel inhibition	NOT	02h	82h
Servo-ON input	SRV-ON	03h	83h
Alarm clear input	A-CLR	04h	Do not setup
Control mode switching input	C-MODE	05h	85h
Gain switching input	GAIN	06h	86h
Deviation counter clear input	CL	07h	Do not setup
Command pulse inhibition input	INH	08h	88h
Torque switching	TC-SEL	09h	89h
Electronic gear switching input 1	DIV1	0Ch	8Ch
Electronic gear switching input 2	DIV2	0Dh	8Dh
Selection 1 input of internal command speed	INTSPD1	0Eh	8Eh
Selection 2 input of internal command speed	INTSPD2	0Fh	8Fh
Selection 3 input of internal command speed	INTSPD3	10h	90h
Speed zero clamp input	ZEROSPD	11h	91h
Speed command sign input	VC-SIGN	12h	92h
Torque command sign input	TC-SIGN	13h	93h
Forced alarm input	E-STOP	14h	94h

Note:

- Normally open means input signal comes from external controller or component, for example: PLC .
- Normally closed means input signal comes from drive internally.
- Don't setup to a value other than that specified in the table .
- Don't assign specific function to 2 or more signals. Duplicated assignment will cause Err21.0 I/F input multiple assignment error 1or Err21.1 I/F input multiple assignment error 2

Pr-Mode related input setup as below:

Input			
Signal name	Symbol	Setup value	
		Normally open	Normally closed
Trigger command	CTRG	20h	A0h
Homing signal	HOME	21h	A1h

Forced stop	STP	22h	A2h
Forward direction JOG	JOG+	23h	A3h
Opposite direction JOG	JOG-	24h	A4h
Positive limit switch	PL	25h	A5h
Negative limit switch	NL	26h	A6h
Homing switch signal	ORG	27h	A7h
Road strength address 0	ADD0	28h	A8h
Road strength address 1	ADD1	29h	A9h
Road strength address 2	ADD2	2ah	Aah
Road strength address 3	ADD3	2bh	Abh

Note:
CTRG, HOME is edge triggered, the active duration must more than 1ms.

Pr4.10*	Name	Output selection DO1			Mode	P	S	T
	Range	0~00FFFFFFh	Unit	—	Default	1		
	Data Type	16bit	Access	R/W	Address	0415H		
	Repower	√						
Pr4.11*	Name	Output selection DO2			Mode	P	S	T
	Range	0~00FFFFFFh	Unit	—	Default	2		
	Data Type	16bit	Access	R/W	Address	0417H		
	Repower	√						

Set digital output functions allocation.

This parameter use 16 binary system do setup

For the function number, please refer to the following Figure.

Signal name	Symbol	Setup value
Invalid	-	00h
Alarm output	Alm	01h
Servo-Ready output	S-RDY	02h
External brake release signal	BRK-OFF	03h
Positioning complete output	INP	04h
At-speed output	AT-SPPED	05h
Torque limitation output	TLC	06h
Zero-speed detection output	ZSP	07h
Velocity coincidence output	V-COIN	08h
Positional command ON/OFF output	P-CMD	0Bh
Speed command ON/OFF output	V-CMD	0Fh
Servo enabled output	SEV-ST	12h
Positive limit active	POT-OUT	15h
Negative limit active	NOT-OUT	16h

Pr-Mode related output setup as below;

Output			
Signal name	Symbol	Setup value	
		Normally open	Normally closed
Command complete	CMD-OK	20h	A0h
Road strength address	MC-OK	21h	A1h
Homing finish	HOME-OK	22h	A2h
Torque limit	TQL	06h	86h

Note:

CMD-OK indicates PR command sent complete, but the motor may not in-position.

MC-OK indicates command complete and the motor in-position.

Pr4. 24	Name	Analog input 1 (AI1) over -voltage setup			Mode	S
	Range	0~100	Unit	0.1v	Default	0
	Data Type	16bit	Access	R/W	Address	0431H
	Repower	-				
Set up the excessive level of the input voltage of analog input 1 by using the voltage associated with offset						

Pr4. 31	Name	Positioning complete range			Mode	P
	Range	0~10000	Unit	0.0001rev	Default	10
	Data Type	16bit	Access	R/W	Address	043FH
	Repower	-				
Set up the timing of positional deviation at which the positioning complete signal (INP1) is output.						

Pr4. 32	Name	Positioning complete output setup			Mode	P
	Range	0~3	Unit	command unit	Default	0
	Data Type	16bit	Access	R/W	Address	0441H
	Repower	-				
Select the condition to output the positioning complete signal (INP1).						
	Setup value	Action of positioning complete signal				
	0	The signal will turn on when the positional deviation is smaller than Pr4.31 [positioning complete range].				
	1	The signal will turn on when there is no position command and position deviation is smaller than Pr4.31 [positioning complete range].				
	2	The signal will turn on when there is no position command, the zero-speed detection signal is ON and the positional deviation is smaller than Pr4.31 [positioning complete range].				
	3	The signal will turn on when there is no position command and the positional deviation is smaller than Pr4.31 [positioning complete range]. Then holds "ON" states until the next position command is entered. Subsequently, ON state is maintained until Pr4.33 INP hold time has elapsed. After the hold time, INP output will be turned ON/OFF according to the coming positional command or condition of the positional deviation.				

Pr4. 33	Name	INP hold time			Mode	P
	Range	0~30000	Unit	1ms	Default	0
	Data Type	16bit	Access	R/W	Address	0443H
	Repower	-				
Set up the hold time when Pr 4.32 positioning complete output setup=3						
	Setup value	State of Positioning complete signal				
	0	The hold time is maintained definitely, keeping ON state until next positional command is received.				
	1-30000	ON state is maintained for setup time (ms)but switched to OFF state as the positional command is received during hold time.				

Pr4. 34	Name	Zero-speed			Mode	P S T
	Range	10~20000	Unit	r/min	Default	50
	Data Type	16bit	Access	R/W	Address	0445H

Pr4.34	Repower	-				
<p>You can set up the timing to feed out the zero-speed detection output signal(ZSP or TCL) in rotate speed (r/min).</p> <p>The zero-speed detection signal(ZSP) will be fed out when the motor speed falls below the setup of this parameter, Pr4.34</p> <ul style="list-style-type: none"> ● The setup of pr4.34 is valid for both positive and negative direction regardless of the motor rotating direction. ● There is hysteresis of 10[r/min] 						

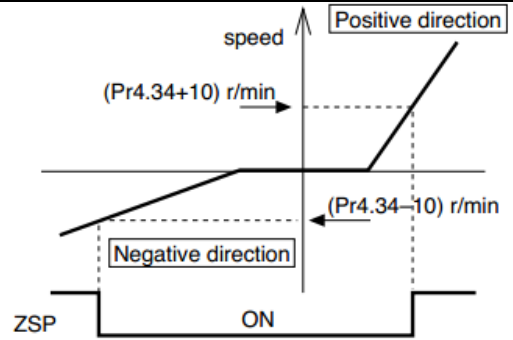

Pr4.35	Name	Speed coincidence range			Mode	S
	Range	10~2000	Unit	r/min	Default	50
	Data Type	16bit	Access	R/W	Address	0447H
	Repower	-				

Set the speed coincidence (V-COIN) output detection timing.

Output the speed coincidence (V-COIN) when the difference between the speed command and the motor speed is equal to or smaller than the speed specified by this parameter.

Because the speed coincidence detection is associated with 10 r/min hysteresis, actual detection range is as shown below.

Speed coincidence output OFF -> ON timing $(Pr4.35 - 10)$ r/min

Speed coincidence output ON -> OFF timing $(Pr4.35 + 10)$ r/min

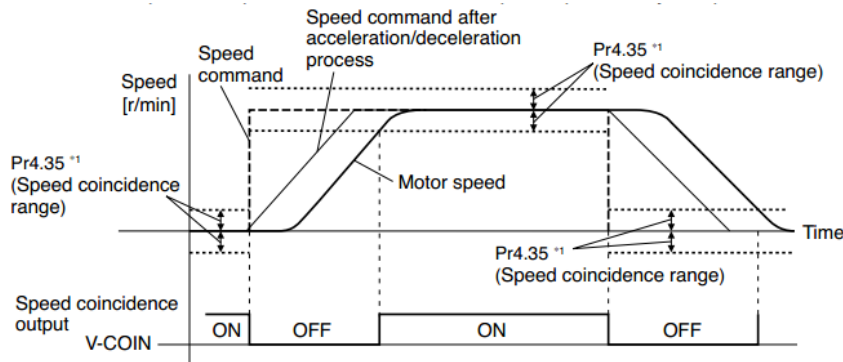

Pr4.36	Name	At-speed(Speed arrival)			Mode	S
	Range	10~2000	Unit	r/min	Default	1000
	Data Type	16bit	Access	R/W	Address	0449H
	Repower	-				

Set the detection timing of the speed arrival output (AT-SPEED).
 When the motor speed exceeds this setup value, the speed arrive output (AT-SPEED) is output.
 Detection is associated with 10r/min hysteresis .

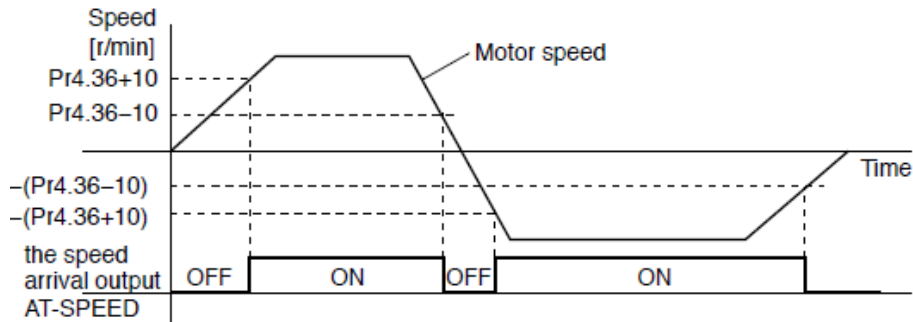

Pr4. 37	Name	Mechanical brake action at stalling setup			Mode	P	S	T
	Range	0~10000	Unit	1ms	Default	0		
	Data Type	16bit	Access	R/W	Address	044BH		
	Repower	-						

Motor brake delay time setup, mainly used to prevent servo on “galloping “phenomenon.
 Set up the time from when the brake release signal(BRK-OFF) turns off to when the motor is de-energized (servo-free),when the motor turns to servo-off while the motor is at stall

- Set up to prevent a micro-travel/drop of the motor (work) due to the action delay time(t_b) of the brake.
- After setting up $Pr4.37 \geq t_b$, then compose the sequence so as the drive turns to servo-off after the brake is actually activated

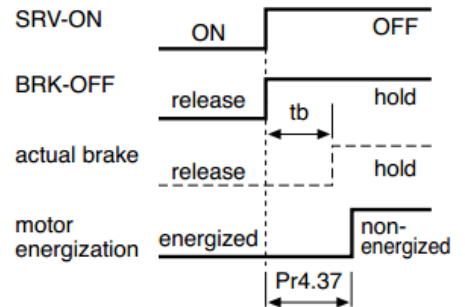

Pr4. 38	Name	Mechanical brake action at running setup			Mode	P	S	T
	Range	0~10000	Unit	1ms	Default	0		
	Data Type	16bit	Access	R/W	Address	044DH		
	Repower	-						

Mechanical brake start delay time setup, it is mainly used to prevent the phenomenon of "Z-axis falling down" when the servo starts up.

Mechanical brake start delay time setup, mainly used to prevent servo off “galloping “phenomenon.
 Set up time from when detecting the off of servo-on input signal(SRV-ON)is to when external brake release signal(BRK-OFF)turns off, while the motor turns to servo off during the motor in motion.

- Set up to prevent the brake deterioration due to the motor running.
- At servo-OFF during the motor is running , t_b of the right fig will be a shorter one of either Pr4.38 setup time, or time lapse till the motor speed falls below Pr4.39 setup speed.

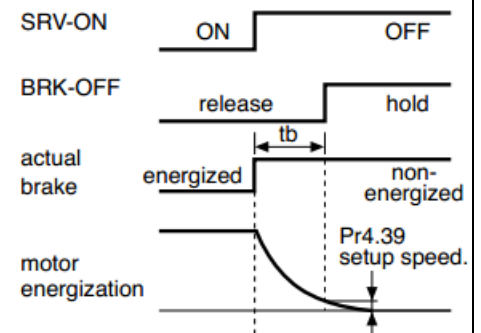

Pr4. 39	Name	Brake release speed setup			Mode	P	S	T
	Range	30~3000	Unit	1ms	Default	30		
	Data Type	16bit	Access	R/W	Address	044FH		
	Repower	-						
Set up the speed timing of brake output checking during operation .								

4.2.6 【Class 5】 Extended Setup

Pr5. 00	Name	2nd Command pulse counts per one motor revolution			Mode	P		
	Range	0-8388608	Unit	P	Default	0		
	Data Type	32bit	Access	R/W	Address	0500H 0501H		
	Repower	√						
Set the command pulse that causes single turn of the motor shaft. Select Pr0.08 1st or Pr5.00 2nd by IO signal. 1) If Pr5.00≠0 , the actual turns = pulse number / Pr5.00 2) If Pr5.00 = 0 , Pr5.01 2nd numerator of electronic gear and Pr5.02 2nd Denominator of electronic Gear become valid.								

Pr5. 01	Name	2nd numerator of electronic gear			Mode	P		
	Range	1~1073741824	Unit	—	Default	1		
	Data Type	32bit	Access	R/W	Address	0502H 0503H		
	Repower	√						

Set the numerator of division/multiplication operation made according to the command pulse input

Pr5. 02	Name	2nd denominator of electronic gear			Mode	P		
	Range	1~1073741824	Unit	—	Default	1		
	Data Type	32bit	Access	R/W	Address	0504H 0505H		
	Repower	o						

Set the denominator of division/multiplication operation made according to the command pulse input.
Instructions refer to Pr0.09 and Pr0.10 and select by IO signal

Pr5. 04	Name	Over-travel inhibit input setup			Mode	P	S	T
	Range	0/1/2	Unit	1ms	Default	0		
	Data Type	16bit	Access	R/W	Address	0509H		
	Repower	-						
0: positive and negative limit effective, no alarm output; 1: positive and negative limit effective invalid; 2: positive and negative limit effective, alarm output;								

Pr5. 06	Name	Servo stop mode			Mode	P	S	T
	Range	0~1	Unit	—	Default	0		
	Data Type	16bit	Access	R/W	Address	050DH		
	Repower	-						

Specify the status during deceleration and after stop, after servo-off.

Setup value	Servo stop mode
0	When servo-disable signal active, servo-disable after the speed reduced less than Pr4.39
1	When servo-disable signal active, servo-disable right away, motor in free-run mode.

Pr5.09 *	Name	The main power-OFF detection time			Mode	P	S	T
	Range	70~2000	Unit	1ms	Default	70		
	Data Type	16bit	Access	R/W	Address	0513H		
	Repower	√						
You can set up the time to detect the shutoff while the main power is kept shut off continuously. The main power off detection is invalid when you set up this to 2000.								

Pr5.11 *	Name	Torque setup for emergency stop			Mode	P	S	T
	Range	0~500	Unit	%	Default	0		
	Data Type	16bit	Access	R/W	Address	051H		
	Repower	-						
Set up the torque limit at emergency stop When setup value is 0, the torque limit for normal operation is applied.								

Pr5.12	Name	Over-load level setup			Mode	P	S	T
	Range	0~115	Unit	%	Default	0		
	Data Type	16bit	Access	R/W	Address	0519H		
	Repower	-						
You can set up over-load level. The overload level becomes 115% by setting up this value to 0. Use this with 0 setup in normal operation, set up other value only when you need to low this over-load level. The setup value of this parameter is limited by 115% of the motor rating.								

Pr5.13	Name	Over-speed level setup			Mode	P	S	T
	Range	0~10000	Unit	r/min	Default	0		
	Data Type	16bit	Access	R/W	Address	051BH		
	Repower	-						
If the motor speed exceeds this setup value, Err1A.0 [over-speed protect] occurs. The over-speed level becomes 1.2 times of the motor max, speed by setting up this to 0.								

Pr5.15 *	Name	I/F reading filter			Mode	P	S	T
	Range	0~255	Unit	0.1ms	Default	0		
	Data Type	16bit	Access	R/W	Address	051FH		
	Repower	√						
I/O input digital filtering; higher setup will arise control delay.								

Pr5.17	Name	Counter clear input mode			Mode	P		
	Range	0~4	Unit	—	Default	3		
	Data Type	16bit	Access	R/W	Address	0523H		
	Repower	-						
Set up the clearing conditions of the counter clear input signal								

Setup value	Clear condition
0/2/4	invalid
1	Always clear
3	Only clear one time

Pr5.20	Name	Position setup unit select			Mode	P		
	Range	0~2	Unit	—	Default	2		
	Data Type	16bit	Access	R/W	Address	0529H		
	Repower	-						
Specify the unit to determine the range of positioning complete and excessive positional deviation								
		Setup value	unit					
		0	Encoder unit					
		1	Command unit					
		2	10000pulse/rotation					

Pr5.21	Name	Selection of torque limit			Mode	P	S	T
	Range	0~5	Unit	—	Default	0		
	Data Type	16bit	Access	R/W	Address	052BH		
	Repower	-						
Set up the torque limiting method								
		Setup value	Limiting value					
		0	PR0.13					
		1	PR5.22					
		2	TL-SEL off	PR0.13				
			TL-SEL on	PR5.22				
		5	Pr0.13 Positive torque limit Pr5.22 Negative torque limit					

Pr5.22	Name	2nd torque limit			Mode	P	S	T
	Range	0~500	Unit	%	Default	300		
	Data Type	16bit	Access	R/W	Address	052DH		
	Repower	-						
Set up the 2nd limit value of the motor torque output The value of the parameter is limited to the maximum torque of the applicable motor.								

Pr5.23	Name	Positive torque reached			Mode	P	S	T
	Range	0~300	Unit	%	Default	0		
	Data Type	16bit	Access	R/W	Address	052FH		
	Repower	-						
<ul style="list-style-type: none"> ● Default setting is 0, if the torque feedback is greater than 95% of the rated torque, output TCL signal. ● If the torque feedback is greater than the user setting value, output TCL signal. 								

Pr5.24	Name	Negative torque reached			Mode	P	S	T
	Range	0~300	Unit	%	Default	0		
	Data Type	16bit	Access	R/W	Address	0531H		
	Repower	-						

- Default setting is 0, if the torque feedback is greater than 95% of the rated torque, output TCL signal.
- If the torque feedback is greater than the user setting value, output TCL signal.

Pr5. 28 *	Name	LED initial status			Mode	P S T
	Range	0~35	Unit	—	Default	1
	Data Type	16bit	Access	R/W	Address	0539H
	Repower	-				
You can select the type of data to be displayed on the front panel LED (7-segment) at the initial status after power-on.						
Setup value		content	Setup value	content	Setup value	content
0	Positional command deviation	12	I/O signal status	24	Reserved	
1	Motor speed	13	Reserved	25	Reserved	
2	Positional command speed	14	Regenerative load rate	26	Reserved	
3	Velocity control command	15	Overload rate	27	Voltage across PN [V]	
4	Actual torque	16	Inertia ratio	28	Drive serial number	
5	Feedback pulse sum	17	Factor of no-motor running	29	Reserved	
6	Command pulse sum	18	Encoder positional deviation [encoder unit]	30	Electromagnetic interference value	
8	Max torque during operation	20	Encoder ID	31	Accumulated operation time	
9	Position command frequency	21	Encoder initial angle	32	Reserved	
10	Control mode	22		33	drive temperature	
11	I/O signal status	23	Number of abnormal communication of encoder	36	Reserved	

Pr5. 29 *	Name	Mode setup of RS485 communication			Mode	P S T
	Range	0~255	Unit	—	Default	5
	Data Type	16bit	Access	R/W	Address	053BH
	Repower	-				
		Setup Value	Data bit	Parity-check	Stop bit	
		0	8	Even Parity	2	
		1	8	Odd Parity	2	
		2	8	Even Parity	1	
		3	8	Odd Parity	1	
		4	8	None	1	
		5	8	None	2	
Pr5. 30 *	Name	Baud rate setup of RS485 communication			Mode	P S T
	Range	0~6	Unit	—	Default	2
	Data Type	16bit	Access	R/W	Address	053DH
	Repower	-				

Set up the communication baud rate of RS485.

Setup value	Baud rate	Setup value	Baud rate
0	2400bps	4	38400bps
1	4800bps	5	57600bps
2	9600bps	6	115200bps
3	19200bps		

Pr5.31 *	Name	RS485 slave axis ID			Mode	P	S	T
	Range	0~127	Unit	—	Default	1		
	Data Type	16bit	Access	R/W	Address	053FH		
	Repower	-						

During communication with the host (e.g. PC) to control multiple shafts, the shaft being accessed by the host should be identified.

Note: when using RS232/RS485, the maximum valid value is 31.

Pr5.32	Name	Command pulse input maximum setup			Mode	P		
	Range	0~4000	Unit	KHZ	Default	0		
	Data Type	16bit	Access	R/W	Address	0541H		
	Repower	-						

Set the maximum number of pulses to be used as command pulse input, if the number of the input pulse exceeds the setup value ,ERR1B0 command pulse input frequency error protection occurs

4.2.7 【Class 6】 Special Setup

Pr6.03	Name	JOG trial run command torque			Mode			T
	Range	0~100	Unit	%	Default	0		
	Data Type	16bit	Access	R/W	Address	0607H		
	Repower	-						

You can set up the command speed used for JOG trial run (torque control).

Pr6.04	Name	JOG trial run command speed			Mode	P	S	T
	Range	0~10000	Unit	r/min	Default	300		
	Data Type	16bit	Access	R/W	Address	0609H		
	Repower	-						

You can set up the command speed used for JOG trial run (velocity control).

Pr6.05	Name	Position 3 rd gain valid time			Mode	P		
	Range	0~1000	Unit	0.1ms	Default	0		
	Data Type	16bit	Access	R/W	Address	060BH		
	Repower	-						

Set up the time at which 3rd gain becomes valid.
 When not using this parameter, set PR6.05=0, PR6.06=100
 This is valid for only position control/full-closed control.

Pr6.06	Name	Position 3 rd gain multiplication			Mode	P		
	Range	0~1000	Unit	100%	Default	0		
	Data Type	16bit	Access	R/W	Address	060DH		
	Repower	-						
Set up the 3 rd gain by multiplying factor of the 1 st gain $3rd\ gain = 1st\ gain * PR6.06/100.$								

Pr6.07	Name	Torque command additional value			Mode	P	S	T
	Range	-100~100	Unit	%	Default	0		
	Data Type	16bit	Access	R/W	Address	060FH		
	Repower	-						
Pr6.08	Name	Positive torque compensation value			Mode	P	S	T
	Range	-100~100	Unit	%	Default	0		
	Data Type	16bit	Access	R/W	Address	0611H		
	Repower	-						
Pr6.09	Name	Negative torque compensation value			Mode	P	S	T
	Range	-100~100	Unit	%	Default	0		
	Data Type	16bit	Access	R/W	Address	0613H		
	Repower	-						
This three parameters may apply feed forward torque superposition directly to torque command.								

Pr6.11	Name	Current response setup			Mode	P	S	T
	Range	50~100	Unit	%	Default	100		
	Data Type	16bit	Access	R/W	Address	0617H		
	Repower	-						
Sets the RMS ratio of the relevant parameters of the driver current loop								

Pr6.13	Name	2 nd inertia ratio			Mode	P	S	T
	Range	0~10000	Unit	%	Default	0		
	Data Type	16bit	Access	R/W	Address	061BH		
	Repower	-						
Set up 2 nd inertia ratio Set up the ratio of the load inertia against the rotor of the motor ratio. $PR6.13 = (load\ inertia / rotor\ inertia) * 100 \text{ 【\%】}$								

Pr6.14	Name	Emergency stop time at alarm			Mode	P	S	T
	Range	0~3000	Unit	ms	Default	200		
	Data Type	16bit	Access	R/W	Address	061DH		
	Repower	-						
Set up the time allowed to complete emergency stop in an alarm condition, exceeding this time puts this system in alarm state.								

Pr6.20	Name	Trial run distance			Mode	P		
	Range	0~1200	Unit	0.1rev	Default	10		

	Data Type	16bit	Access	R/W	Address	0629H
	Repower	-				

The distance of running each time in JOG run(position control)

Pr6. 21	Name	Trial run waiting time			Mode	P		
	Range	0~30000	Unit	Ms	Default	100		
	Data Type	16bit	Access	R/W	Address	062BH		
	Repower	-						

The waiting time after running each time in JOG run(position control)

Pr6. 22	Name	Trial run cycle times			Mode	P		
	Range	0~32767	Unit	—	Default	5		
	Data Type	16bit	Access	R/W	Address	062DH		
	Repower	-						

The cycling times of JOG run(position control)

Pr6. 25	Name	Acceleration of trial running			Mode	P	S	
	Range	0~32767	Unit	ms	Default	100		
	Data Type	16bit	Access	R/W	Address	0633H		
	Repower	-						

Acceleration time from 0rpm~1000rpm of trial running

Pr6. 63	Name	Position upper Limit of multi-turn ABS encoder			Mode	P	S	T
	Range	0~32766	Unit	Rotation	Default	0		
	Data Type	16bit	Access	R/W	Address	067FH		
	Repower	o						

While Pr0.15=2: Absolute position rotation mode:
 The encoder is used as an absolute encoder, and the position retentive at power failure is supported..
 It is mainly applicable to the scenario where the load travel range is not limited and the number of motor single-direction revolution is less than 0~(Pr6.63+1)

4.2.8 【Class 7】 Factory setting

Pr7. 15	Name	Motor model input			Mode	P	S	T
	Range	0~7FFF	Unit	--	Default	0		

Pr7. 31	Name	Regenerative resistance control mode setting			Mode	P	S	T
	Range	0~2	Unit	--	Default	0		

Setup value	Details
0	Disable regenerative resistance discharge
1	Enable reactive pump lift suppression function
2	Enable regenerative resistance discharge

Notice:

Pr7. 32	Name	Regenerative resistance open threshold setting			Mode	P	S	T
---------	------	--	--	--	------	---	---	---

	Range	20~90	Unit	V	Default	80
The external resistance is activated when the actual bus voltage is higher than Pr7.32 plus Pr7.33 and is deactivated when the actual bus voltage is lower than Pr7.32 minus Pr7.33						
Notice:						

Pr7.33	Name	Regenerative resistance control hysteresis			Mode	P S T
	Range	1~50	Unit	V	Default	5
The external resistance is activated when the actual bus voltage is higher than Pr7.32 plus Pr7.33 and is deactivated when the actual bus voltage is lower than Pr7.32 minus Pr7.33						
Notice:						

4.2.8 【Class B】 Status Information

Note: This parameters class is only for RS485 communication.

PrB.00	Name	Software version 1 (DSP)			Mode	P S T
	Range		Unit		Default	
	Data Type	16bit	Access	R	Address	0B00H
Display Software version 1 (DSP)						

PrB.01	Name	Software version 2 (CPLD)			Mode	P S T
	Range		Unit		Default	
	Data Type	16bit	Access	R	Address	0B01H
Display Software version 2 (CPLD)						

PrB.02	Name	Software version 3 (other)			Mode	P S T
	Range		Unit		Default	
	Data Type	16bit	Access	R	Address	0B02H
Display Software version 3						

PrB.03	Name	Error code			Mode	P S T
	Range		Unit		Default	
	Data Type	16bit	Access	R	Address	0B03H
Display Error code						

PrB.04	Name	Factor of no-motor running			Mode	P S T
	Range		Unit		Default	
	Data Type	16bit	Access	R	Address	0B04H
Factor of no-motor running						

PrB.05	Name	Drive operating state			Mode	P S T
	Range		Unit		Default	
	Data Type	16bit	Access	R	Address	0B05H

Bit	Function	Details
0	RDY	Servo ready
1	RUN	Servo run
2	ERR	Servo error
3	HOME_OK	Homing process finished in Pr-Mode
4	INP	Positioning complete
5	AT-SPEED	At-speed
6~15		Reserve

PrB. 06	Name	Actual velocity (unfiltered)			Mode	P	S	T
	Range		Unit	RPM	Default			
	Data Type	16bit	Access	R	Address	0B06H		
Actual velocity (unfiltered)								

PrB. 07	Name	Actual torque feedback			Mode	P	S	T
	Range		Unit	%	Default			
	Data Type	16bit	Access	R	Address	0B07H		
Actual torque feedback (Percentage of the rated torque)								

PrB. 08	Name	Actual current feedback			Mode	P	S	T
	Range		Unit	0.01A	Default			
	Data Type	16bit	Access	R	Address	0B08H		
Actual current feedback								

PrB. 09	Name	Actual velocity(After filtering)			Mode	P	S	T
	Range		Unit	RPM	Default			
	Data Type	16bit	Access	R	Address	0B09H		
Speed (After filtering)								

PrB. 10	Name	DC bus voltage			Mode	P	S	T
	Range		Unit	V	Default			
	Data Type	16bit	Access	R	Address	0B0AH		
DC bus voltage								

PrB. 11	Name	Drive temperature			Mode	P	S	T
	Range		Unit	℃	Default			
	Data Type	16bit	Access	R	Address	0B0BH		
Drive temperature								

PrB. 15	Name	Over-load ratio			Mode	P	S	T
	Range		Unit	%	Default			
	Data Type	16bit	Access	R	Address	0B0FH		

Over-load ratio (%)

PrB. 16	Name	Regeneration load ratio			Mode	P	S	T
	Range		Unit	%	Default			
	Data Type	16bit	Access	R	Address	0B10H		
Regeneration load ratio (%)								

PrB. 17	Name	Digital input signal status			Mode	P	S	T												
	Range		Unit		Default															
	Data Type	16bit	Access	R	Address	0B11H														
Digital input signal status: <table border="1" data-bbox="327 645 730 907" style="display: inline-table; vertical-align: top;"> <thead> <tr> <th>Bit</th> <th>SI input</th> </tr> </thead> <tbody> <tr> <td>0</td> <td>SI1</td> </tr> <tr> <td>1</td> <td>SI2</td> </tr> <tr> <td>2</td> <td>SI3</td> </tr> <tr> <td>...</td> <td>...</td> </tr> <tr> <td>8</td> <td>SI9</td> </tr> </tbody> </table> <div style="display: inline-block; vertical-align: top; margin-left: 20px;"> Bit n=1, indicates SI(n+1)is at high level; Bit n=0, indicates SI(n+1)is at low level. </div>									Bit	SI input	0	SI1	1	SI2	2	SI3	8	SI9
Bit	SI input																			
0	SI1																			
1	SI2																			
2	SI3																			
...	...																			
8	SI9																			

PrB. 18	Name	Digital output signal status			Mode	P	S	T								
	Range		Unit		Default											
	Data Type	16bit	Access	R	Address	0B11H										
Digital output signal status: <table border="1" data-bbox="338 1137 742 1310" style="display: inline-table; vertical-align: top;"> <thead> <tr> <th>Bit</th> <th>DO output</th> </tr> </thead> <tbody> <tr> <td>0</td> <td>DO1</td> </tr> <tr> <td>1</td> <td>DO2</td> </tr> <tr> <td>2</td> <td>DO3</td> </tr> </tbody> </table> <div style="display: inline-block; vertical-align: top; margin-left: 20px;"> Bit n=1, indicates DO(n+1)is at high level; Bitn=0,indacates DO(n+1)is at low level. </div>									Bit	DO output	0	DO1	1	DO2	2	DO3
Bit	DO output															
0	DO1															
1	DO2															
2	DO3															

PrB. 20	Name	Motor position feedback (Command unit)			Mode	P	R	
	Range		Unit	P	Default			
	Data Type	32bit	Access	R	Address	0B14H~0B15H		
Motor position feedback (Command unit) . If the drive receives 8388608 pulse, and the drive's instruction unit is 10000pulse/ r, the encoder unit is 8388608 pulse/r, then the drive motor position feedback pulse number is 10000P								

PrB. 21	Name	Command pulse sum (Command unit)			Mode	P		
	Range		Unit	P	Default			
	Data Type	32bit	Access	R	Address	0B16H~0B17H		
Command pulse sum (Command unit)								

PrB. 22	Name	Positional deviation (Command unit)			Mode	P		
	Range		Unit	P	Default			
	Data Type	32bit	Access	R	Address	0B18H~0B19H		

Positional deviation (Command unit) , refer to PrB.23 for details.

PrB. 23	Name	Position command (Encoder unit)			Mode	P		
	Range		Unit		Default			
	Data Type	32bit	Access	R	Address	0B1AH~0B1BH		
Position command (Encoder unit) If the drive's instruction unit is 10000pulse/ r, the encoder unit is 8388608 pulse/r, then the drive receive 10000pulse, the position command pulse number is 8388608 pulse								

PrB. 24	Name	Motor position (encoder unit)			Mode	P		
	Range		Unit		Default			
	Data Type	32bit	Access	R	Address	0B1CH~0B1DH		
Motor position (encoder unit)								

PrB. 25	Name	Positional deviation(encoder unit)			Mode	P		
	Range		Unit		Default			
	Data Type	32bit	Access	R	Address	0B1EH~0B1FH		
Positional deviation(encoder unit)								

PrB. 26	Name	Position feedback in rotation mode(encoder unit)			Mode	P		
	Range		Unit		Default			
	Data Type	32bit	Access	R	Address	0B20H~0B21FH		
Position feedback in rotation mode(encoder unit), refer to PrB.23 for details.								

Chapter 5 Trial Run



Attention

- Ground the earth terminal of the motor and driver without fail. the PE terminal of driver must be reliably connected with the grounding terminal of equipment.
- The driver power need with isolation transformer and power filter in order to guarantee the security and anti-jamming capability.
- Check the wiring to make sure correctness before power on.
- Install a emergency stop protection circuit externally, the protection can stop running immediately to prevent accident happened and the power can be cut off immediately.
- If drive alarm occurs, the cause of alarm should be excluded and Svon signal must be invalid before restarting the driver.
- Please don't touch terminal strip or separate the wiring.

Note: there are two kinds of trial run : trial run without load and trial run with load . The user need to test the driver without load for safety first.

Contact tech@leadshine.com for more technical support .

5.1 Inspection Before trial Run

5.1.1 Inspection on wiring

Table 6.1 Inspection Item Before Run

No	Item	Content
1	Inspection on wiring	<ul style="list-style-type: none"> • Ensure the following terminals are properly wired and securely connected : <ul style="list-style-type: none"> ✓ the input power terminals, ✓ motor output power terminal , ✓ encoder input terminal CN2, ✓ control signal terminal CN1, ✓ communication terminal CN3(no need to connect CN1&CN3 in Jog mode) • short circuit among power input lines and motor output lines are forbidden , and no short circuit connected with PG ground.
2	Confirmation of power supply	The range of control power input Vdc, GND must be in the rated range(24-70Vdc).
3	Fixing of position	the motor and driver must be firmly fixed
4	Inspection without load	the motor shaft must not be with a mechanical load.
5	Inspection on control signal	1, all of the control switch must be placed in OFF state. 2, servo enable input Srv_on must be in OFF state.

5.1.2 Timing chart on power-up

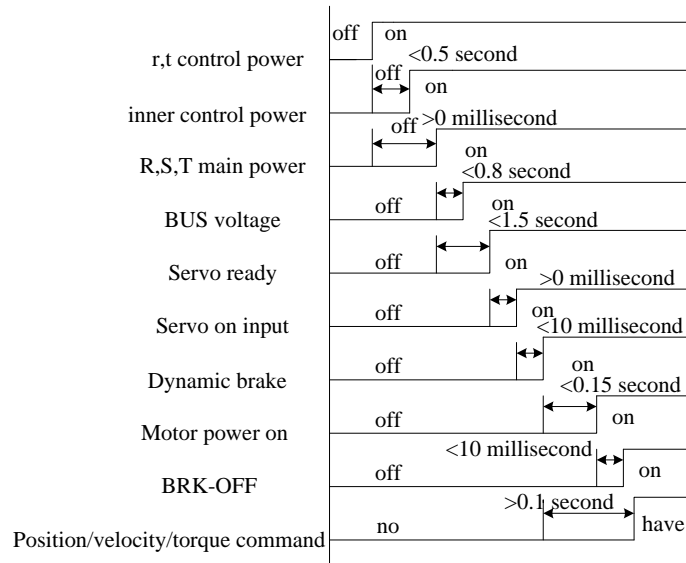

5.1.3 Timing chart on fault

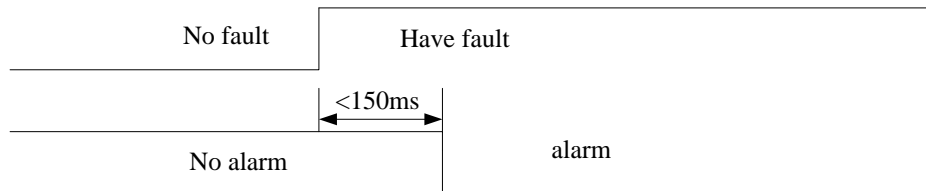

5.1.4 Holding brake

In applications where the motor drives the vertical axis, this brake would be used to hold and prevent the work (moving load) from falling gravity while the power to the servo is shut off.

Pin1/2 (DO+/DO-) can be used to release the brake of motor directly.

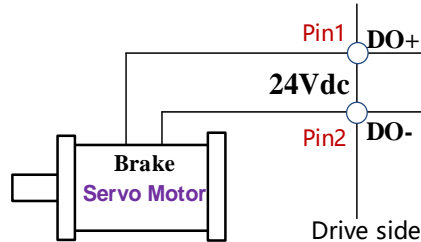

About the wire of brake, there should be an 24VDC for brake, the brake will be released with the 24VDC input, and the drive provide an output signal to control the connection or disconnection of the 24VDC, and it is forbidden to connect these signal directly for the power of 24VDC, it will destroy the hardware of servo drive.

5.2 Position Control

Notice : You must do inspection before position control test run.

Table 6.2 Parameter Setup of Position Control

No	Parameter	Name	Input	Value	Unit
1	Pr0.01	control mode setup	/	0	/
2	Pr0.06	command pulse rotational direction setup		0	
3	Pr0.07	command pulse input mode setup		0~3	
4	Pr0.08	Command pulse per one motor revolution		User-specified	Pulse
5	Pr0.09	1st numerator of electronic gear		1	
6	Pr0.10	denominator of electronic gear		1	
7	Pr2.22	positional command smoothing filter		User-specified	0.1ms
8	Pr2.23	positional command FIR filter		User-specified	0.1ms
9	Pr3.12	Acceleration time setup	/	User-specified	millisecond
10	Pr3.13	Deceleration time setup	/	User-specified	millisecond
11	Pr3.14	Sigmoid acceleration/deceleration time setup	/	User-specified	millisecond
12	Pr4.02	DI3 input select: servo-enable	Srv_on	Hex:0003	/

◆ Wiring Diagram

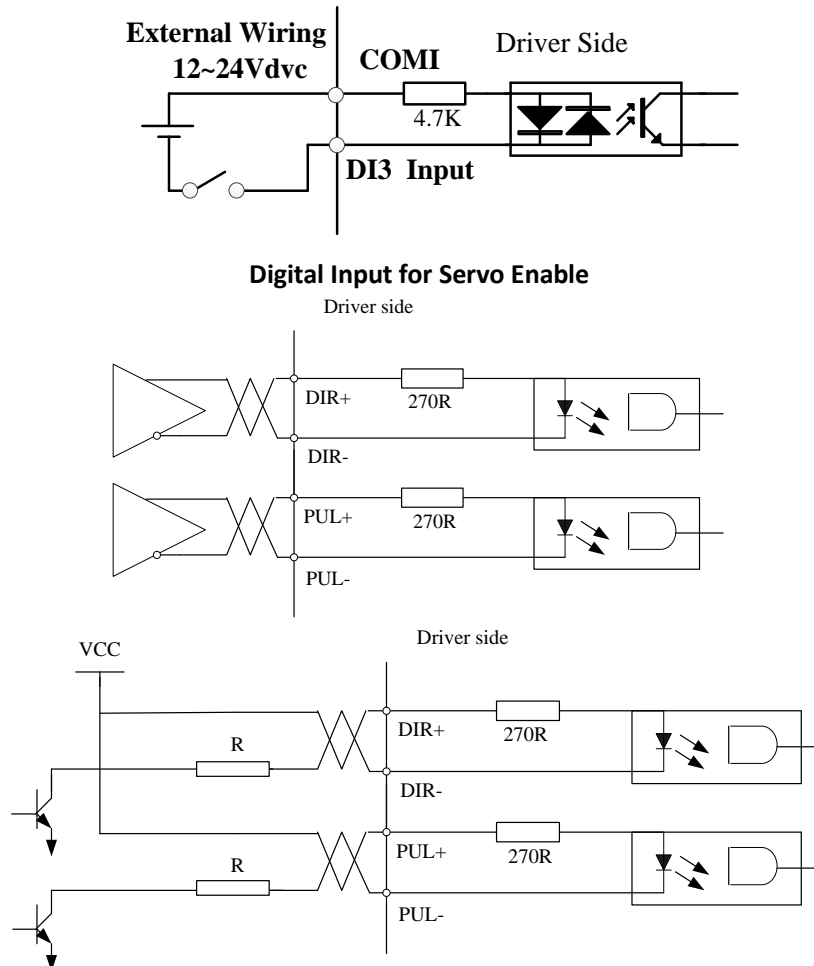
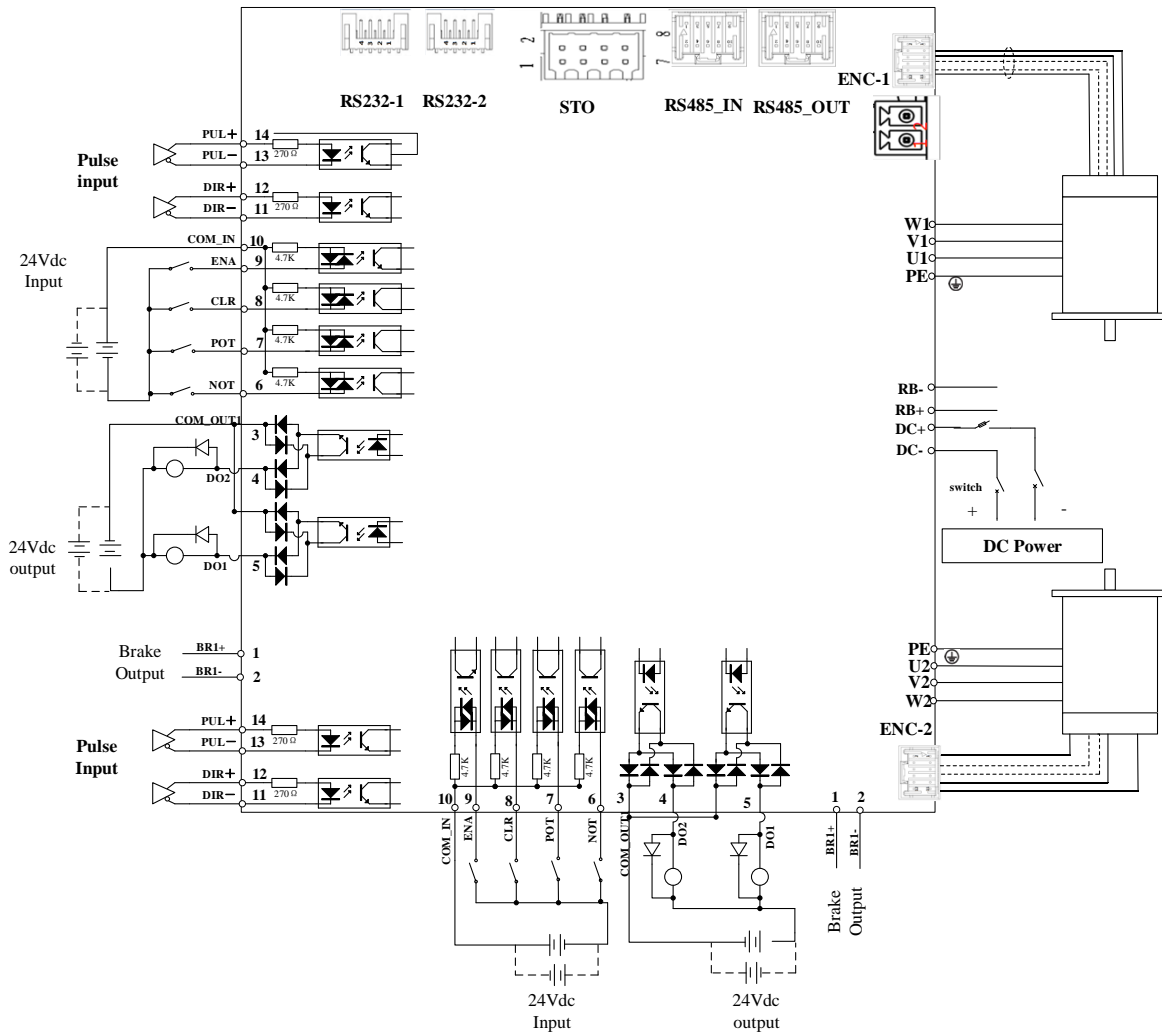

Figure 6-1 CN1 and CN2 Signal Wiring in Position Control Mode

Figure 6-2 Position Mode Wiring
Notes:

1. Only support 5V pulse and direction signal, 2KΩ resistor must installed with 24V pulse and direction signal.
2. 4 digital inputs DI3~DI6, support NPN and PNP connection, recommend 12~24V input signal.
3. 2 digital outputs DO1~DO2, support NPN and PNP connection, recommend 24V output signal.

◆ Operation Steps

1. Connect terminal CN1.
2. Connect DC12V to 24V to digital input DI3 to ENABLE drive (the COMI and DI3).
3. Power on the drive.
4. Confirm the value of the parameters, and write to the EEPROM and turn off/on the power (of the drive)
5. Connect the Srv_on input to enable drive and energize the motor.
6. Enter low-frequency pulse and direction signal to run the motor at low speed.
7. Check the motor rotational speed at monitor mode whether, ("d01SP"),

Rotational speed is as setup or not, and the motor stops by stopping the command (pulse) or not
 If the motor does not run correctly, refer to the Factor of No-Motor running in data monitor mode ("d17Ch").

Related parameters setup of position mode

5.2.1 Pulse command and rotation direction







The positional commands of the following 3 types (pulse train) are available.

- ◆ A, B phase pulse
- ◆ Positive direction pulse/negative direction pulse
- ◆ Pulse + direction

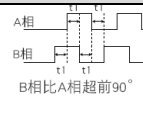
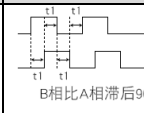
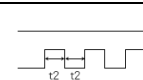
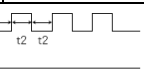
Pr0.06*	Name	Command Pulse Rotational Direction Setup			Mode	P		
	Range	0~1	Unit	—	Default	0		
	Data Type	16bit	Access	R/W	Address	000DH		
	Repower	√						

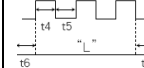
Set command pulse input rotate direction, command pulse input type

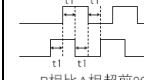
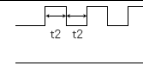
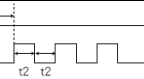
Pr0.07*	Name	Command Pulse Input Mode Setup			Mode	P		
	Range	0~3	Unit	—	Default	1		
	Data Type	16bit	Access	R/W	Address	000FH		
	Repower	√						

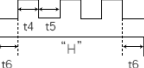
Pr0.06	Pr0.07	Command Pulse Format	Signal	Positive Direction Command	Negative Direction Command
0	0 or 2	90 phase difference 2-phase pulse(A phase +B phase)	Pulse sign	 B相比A相超前90°	 B相比A相滞后90°
	1	Positive direction pulse + negative direction pulse	Pulse sign		
	3	Pulse + sign	Pulse sign		
1	0 or 2	90 phase difference 2 phase pulse(A phase +B phase)	Pulse sign	 B相比A相滞后90°	 B相比A相超前90°
	1	Positive direction pulse + negative direction pulse	Pulse sign		
	3	Pulse + sign	Pulse sign		

Command pulse input signal allow largest frequency and smallest time width

PULS/SIGN Signal Input I/F		Permissible Max. Input Frequency	Smallest Time Width					
			t1	t2	t3	t4	t5	t6
Pulse series interface	Long distance interface	500kpps	2	1	1	1	1	1
	Open-collector output	200kpps	5	2.5	2.5	2.5	2.5	2.5

5.2.2 Electronic gear function

The function multiplies the input pulse command from the host controller by the predetermined dividing or multiplying factor and applies the result to the position control section as the positional command. By using this function, desired motor rotations or movement distance per unit input command pulse can be set.

Pr0.08	Name	Command pulse counts per one motor revolution			Mode	P	S	T
	Range	0-8388608	Unit	P	Default	0		

	Data Type	32bit	Access	R/W	Address	0010H 0011H
	Repower	√				

Set the command pulse that causes single turn of the motor shaft.

- 1) If Pr008≠0 , the actual motor rotation turns = pulse number / Pr0.08
- 2) If Pr008 = 0 , Pr0.09 1st numerator of electronic gear and Pr0.10 Denominator of electronic gear valid.

Pr0. 09	Name	1st numerator of electronic gear			Mode	P
	Range	1~1073741824	Unit	—	Default	1
	Data Type	32bit	Access	R/W	Address	0012H 0013H
	Repower	√				

Set the numerator of division/multiplication operation made according to the command pulse input.

Pr0. 10	Name	1st denominator of electronic gear			Mode	P
	Range	1~1073741824	Unit	—	Default	1
	Data Type	32bit	Access	R/W	Address	0014H 0015H
	Repower	√				

Set the denominator of division/multiplication operation made according to the command pulse input.

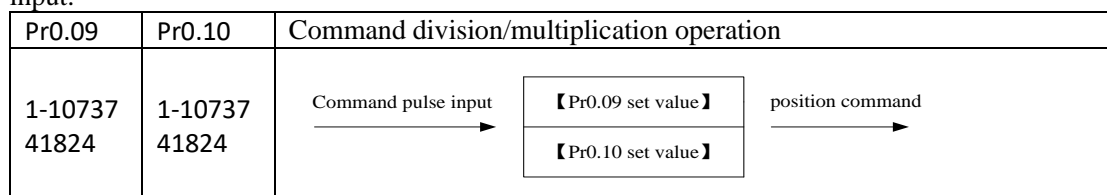

1. Settings:

- 1)The drive input command pulse number is X
- 2)The pulse number of encoder after frequency division and frequency doubling is Y
- 3)The number of pulses per revolution of the motor encoder is Z
- 4)Number of turns of motor is W

2. Calculations:

- 1)Y=X* Pr0.09 / Pr0.10
- 2)17Bit encoder: Z=2¹⁷ = 131072
- 23Bit encoder: Z=2²³ = 8388608

5.2.3 Position command filter

To make the positional command divided or multiplied by the electronic gear smooth, set the command filter.

In the following situations, it is necessary to consider adding position command filtering:

- 1) The position instruction output by the controller is not accelerated or decelerated;
- 2) Low command pulse frequency;
- 3) when the electronic gear ratio is more than 10 times.

The position command filter can make the position command smoother and the motor rotation more stable.

Pr2. 22	Name	positional command smoothing filter			Mode	P
	Range	0~32767	Unit	0.1ms	Default	0
	Data Type	16bit	Access	R/W	Address	022DH
	Repower	√				

- Set up the time constant of the 1st delay filter in response to the positional command.
- When a square wave command for the target speed V_c is applied, set up the time constant of the 1st delay filter as shown in the figure below

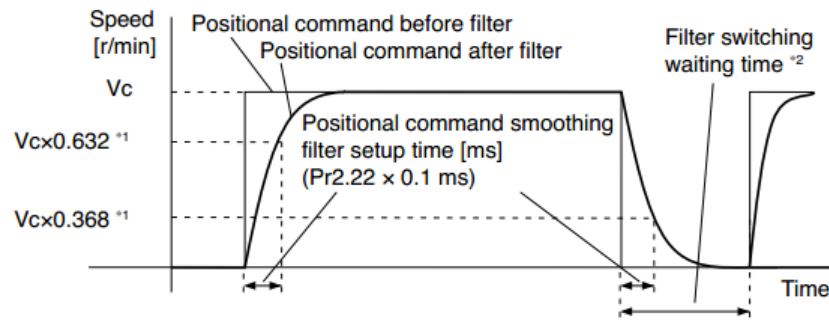

Pr2. 23	Name	positional command FIR filter			Mode	P	
	Range	0~10000	Unit	0.1ms	Default	0	
	Data Type	16bit	Access	R/W	Address	022FH	
	Repower	√					

- Set up the time constant of the 1st delay filter in response to the positional command.
- When a square wave command for the target speed V_c is applied, set up the V_c arrival time as shown in the figure below.

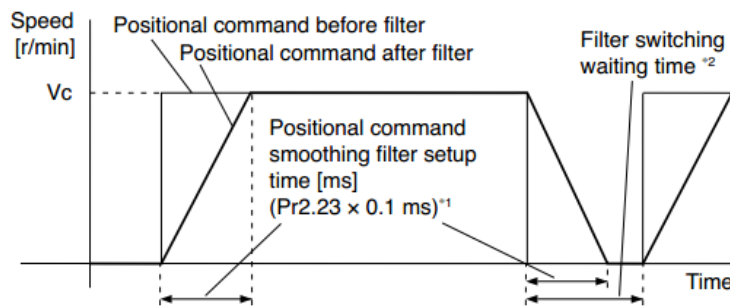

5.2.4 Motor encoder pulse output

The information on the amount of movement can be sent to the host controller in the form of A and B phase pulses from the servo drive.

Pr0. 11 *	Name	Output pulse counts per one motor revolution			Mode	P	S	T
	Range	1~2500	Unit	P/r	Default	2500		
	Data Type	16bit	Access	R/W	Address	0017H		
	Repower	√						

For example, if this parameter is set to 1000, it means that the frequency division output signal of the encoder outputs 4000 pulses per turn.

Pr0. 12 *	Name	reversal of pulse output logic			Mode	P	S	T
	Range	0~1	Unit	—	Default	0		
	Data type	16bit	Access	R/W	Address	0019H		
	Repower	√						

You can set up the B phase logic and the output source of the pulse output. With this parameter, you can reverse the phase relation between the A-phase pulse and B-phase pulse by reversing the B-phase logic.

< reversal of pulse output logic >

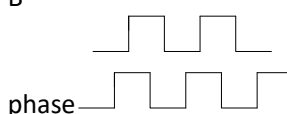
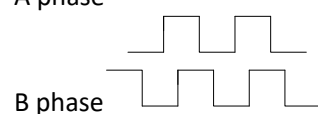
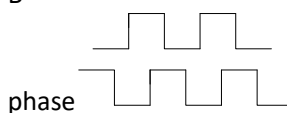
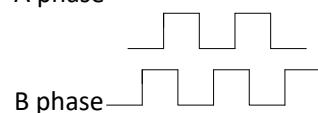
Pr0.12	B-phase Logic	CCW Direction Rotation	CW Direction Rotation
0	Standard	A phase B 	A phase B phase 
1	Reverse	A phase B 	A phase B phase 

Notes: ELD2 series encoder has no Z signal output and no frequency division function.

5.2.5 Position complete output (INP)

The completion of positioning can be verified by the positioning complete output (INP). When the absolute value of the positional deviation counter at the position control is equal to or below the positioning complete

Range by the parameter, the output is ON. Presence and absence of positional command can be specified as one of judgment conditions.

Pr4.31	Name	Positioning complete range			Mode	P	
	Range	0~10000	Unit	0.0001rev	Default	10	
	Data Type	16bit	Access	R/W	Address	043FH	
	Repower	-					
Set up the timing of positional deviation at which the positioning complete signal (INP1) is output.							

Pr4.32	Name	Positioning complete output setup			Mode	P	
	Range	0~3	Unit	command unit	Default	0	
	Data Type	16bit	Access	R/W	Address	0441H	
	Repower	-					
Select the condition to output the positioning complete signal (INP1).							
	Setup value	Action of positioning complete signal					
	0	The signal will turn on when the positional deviation is smaller than Pr4.31 [positioning complete range].					
	1	The signal will turn on when there is no position command and position deviation is smaller than Pr4.31 [positioning complete range].					
	2	The signal will turn on when there is no position command, the zero-speed detection signal is ON and the positional deviation is smaller than Pr4.31 [positioning complete range].					
	3	The signal will turn on when there is no position command and the positional deviation is smaller than Pr4.31 [positioning complete range]. Then holds "ON" states until the next position command is entered. Subsequently, ON state is maintained until Pr4.33 INP hold time has elapsed. After the hold time, INP output will be turned ON/OFF according to the coming positional command or condition of the positional deviation.					

Pr4.33	Name	INP hold time			Mode	P	
	Range	0~30000	Unit	1ms	Default	0	

Data Type	Data Type	16bit	Access	R/W	Address	0443H
	Repower	-				
Set up the hold time when Pr 4.32 positioning complete output setup=3						
Setup value		State of Positioning complete signal				
0		The hold time is maintained definitely, keeping ON state until next positional command is received.				
1-30000		ON state is maintained for setup time (ms)but switched to OFF state as the positional command is received during hold time.				

And the output port should be assigned for “INP”, for details of these parameters, refer to Pr410 – Pr415.

5.3 Velocity Control

The drive is widely used for accuracy speed control in velocity control mode. You can control the speed according to the analog speed command from the host controller or the speed command set in servo drive.

Notice : You must do inspection before position control test run.

5.3.1 Velocity mode control by internal speed command

Table 6.4 Parameter Setup of Velocity Controlled by analog input

No	Parameter	Name	input	Setup value	Unit
1	Pr0.01	Control mode setup	/	1	/
2	Pr3.12	Acceleration time setup	/	User-specified	millisecond
3	Pr3.13	Deceleration time setup	/	User-specified	millisecond
4	Pr3.14	Sigmoid acceleration/deceleration time setup	/	User-specified	millisecond
5	Pr3.15	Zero speed clamping function select	/	2	/
6	Pr3.00	Velocity setup internal and external switching	/	3	/
7	Pr3.01	Speed Command direction selection	/	User-specified	/
12	Pr4.02	DI3 input select: servo-enable		Hex:0003	/

◆ Wiring Diagram

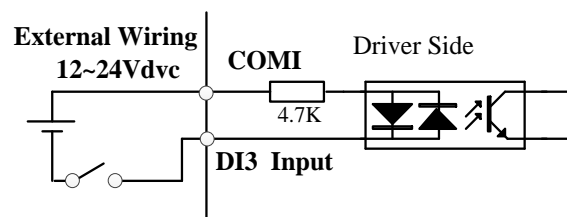

Digital Input for Servo Enable

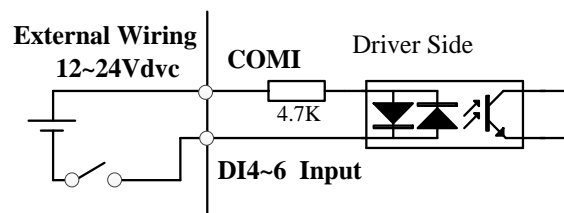

Digital Input for Velocity Control_ INTSPD1/ INTSPD2/ INTSPD3/ VC-SIGN

You can control the speed by using the internal speed command set to the parameter. By using the internal speed command selection 1,2,3(INTSPD 1,2,3), you can select best appropriate one

Pr3.00	Name	Speed setup, Internal /External switching			Mode	S																																																						
	Range	0~3	Unit	—	Default	0																																																						
	Data Type	16bit	Access	R/W	Address	0301H																																																						
	Repower	-																																																										
This drive is equipped with internal speed setup function so that you can control the speed with contact inputs only.																																																												
<table border="1" style="width: 100%; border-collapse: collapse;"> <thead> <tr style="background-color: #D3D3D3;"> <th>Setup value</th> <th>Speed setup method</th> </tr> </thead> <tbody> <tr> <td style="text-align: center;">1</td> <td>Internal speed command 1st to 4th speed(PR3.04-PR3.07)</td> </tr> <tr> <td style="text-align: center;">2</td> <td>Internal speed command 1st to 3rd speed (PR3.04-PR3.06), Analog speed command(SPR)</td> </tr> <tr> <td style="text-align: center;">3</td> <td>Internal speed command 1st to 8th speed (PR3.04-PR3.11)</td> </tr> </tbody> </table>							Setup value	Speed setup method	1	Internal speed command 1st to 4th speed(PR3.04-PR3.07)	2	Internal speed command 1st to 3rd speed (PR3.04-PR3.06), Analog speed command(SPR)	3	Internal speed command 1st to 8th speed (PR3.04-PR3.11)																																														
Setup value	Speed setup method																																																											
1	Internal speed command 1st to 4th speed(PR3.04-PR3.07)																																																											
2	Internal speed command 1st to 3rd speed (PR3.04-PR3.06), Analog speed command(SPR)																																																											
3	Internal speed command 1st to 8th speed (PR3.04-PR3.11)																																																											
<relationship between Pr3.00 Internal/External switching speed setup and the internal command speed selection 1-3 and speed command to be selected>																																																												
<table border="1" style="width: 100%; border-collapse: collapse;"> <thead> <tr style="background-color: #D3D3D3;"> <th>Setup value</th> <th>selection 1 of internal command speed (INTSPD1)</th> <th>selection 2 of internal command speed (INTSPD2)</th> <th>selection 3 of internal command speed (INTSPD3)</th> <th>selection of Speed command</th> </tr> </thead> <tbody> <tr> <td rowspan="4" style="text-align: center;">1</td> <td>OFF</td> <td>OFF</td> <td rowspan="4" style="text-align: center;">NO effect</td> <td>1st speed</td> </tr> <tr> <td>ON</td> <td>OFF</td> <td>2nd speed</td> </tr> <tr> <td>OFF</td> <td>ON</td> <td>3rd speed</td> </tr> <tr> <td>ON</td> <td>ON</td> <td>4th speed</td> </tr> <tr> <td rowspan="4" style="text-align: center;">2</td> <td>OFF</td> <td>OFF</td> <td rowspan="4" style="text-align: center;">NO effect</td> <td>1st speed</td> </tr> <tr> <td>ON</td> <td>OFF</td> <td>2nd speed</td> </tr> <tr> <td>OFF</td> <td>ON</td> <td>3rd speed</td> </tr> <tr> <td>ON</td> <td>ON</td> <td>Analog speed command</td> </tr> <tr> <td rowspan="5" style="text-align: center;">3</td> <td colspan="2">The same as [Pr3.00=1]</td> <td>OFF</td> <td>1st to 4th speed</td> </tr> <tr> <td>OFF</td> <td>OFF</td> <td>ON</td> <td>5th speed</td> </tr> <tr> <td>ON</td> <td>OFF</td> <td>ON</td> <td>6th speed</td> </tr> <tr> <td>OFF</td> <td>ON</td> <td>ON</td> <td>7th speed</td> </tr> <tr> <td>ON</td> <td>ON</td> <td>ON</td> <td>8th speed</td> </tr> </tbody> </table>							Setup value	selection 1 of internal command speed (INTSPD1)	selection 2 of internal command speed (INTSPD2)	selection 3 of internal command speed (INTSPD3)	selection of Speed command	1	OFF	OFF	NO effect	1st speed	ON	OFF	2nd speed	OFF	ON	3rd speed	ON	ON	4th speed	2	OFF	OFF	NO effect	1st speed	ON	OFF	2nd speed	OFF	ON	3rd speed	ON	ON	Analog speed command	3	The same as [Pr3.00=1]		OFF	1st to 4th speed	OFF	OFF	ON	5th speed	ON	OFF	ON	6th speed	OFF	ON	ON	7th speed	ON	ON	ON	8th speed
Setup value	selection 1 of internal command speed (INTSPD1)	selection 2 of internal command speed (INTSPD2)	selection 3 of internal command speed (INTSPD3)	selection of Speed command																																																								
1	OFF	OFF	NO effect	1st speed																																																								
	ON	OFF		2nd speed																																																								
	OFF	ON		3rd speed																																																								
	ON	ON		4th speed																																																								
2	OFF	OFF	NO effect	1st speed																																																								
	ON	OFF		2nd speed																																																								
	OFF	ON		3rd speed																																																								
	ON	ON		Analog speed command																																																								
3	The same as [Pr3.00=1]		OFF	1st to 4th speed																																																								
	OFF	OFF	ON	5th speed																																																								
	ON	OFF	ON	6th speed																																																								
	OFF	ON	ON	7th speed																																																								
	ON	ON	ON	8th speed																																																								

Pr3.01	Name	Speed command rotational direction selection			Mode	S																		
	Range	0~1	Unit	—	Default	0																		
	Data Type	16bit	Access	R/W	Address	0303H																		
	Repower	-																						
Select the Positive /Negative direction specifying method																								
<table border="1" style="width: 100%; border-collapse: collapse;"> <thead> <tr style="background-color: #D3D3D3;"> <th>Setup value</th> <th>Select speed command sign (1st to 8th speed)</th> <th>Speed command direction (VC-SIGN)</th> <th>Position command direction</th> </tr> </thead> <tbody> <tr> <td rowspan="2" style="text-align: center;">0</td> <td>+</td> <td>No effect</td> <td>Positive direction</td> </tr> <tr> <td>-</td> <td>No effect</td> <td>Negative direction</td> </tr> <tr> <td rowspan="2" style="text-align: center;">1</td> <td>Sign has no effect</td> <td>OFF</td> <td>Positive direction</td> </tr> <tr> <td>Sign has no effect</td> <td>ON</td> <td>Negative direction</td> </tr> </tbody> </table>							Setup value	Select speed command sign (1st to 8th speed)	Speed command direction (VC-SIGN)	Position command direction	0	+	No effect	Positive direction	-	No effect	Negative direction	1	Sign has no effect	OFF	Positive direction	Sign has no effect	ON	Negative direction
Setup value	Select speed command sign (1st to 8th speed)	Speed command direction (VC-SIGN)	Position command direction																					
0	+	No effect	Positive direction																					
	-	No effect	Negative direction																					
1	Sign has no effect	OFF	Positive direction																					
	Sign has no effect	ON	Negative direction																					

Pr3.02	Name	Input gain of speed command			Mode	S
	Range	10~2000	Unit	(r/min)/V	Default	500
	Data Type	16bit	Access	R/W	Address	0305H
	Repower	-				

Based on the voltage applied to the analog speed command (SPR), set up the conversion gain to motor command speed.

You can set up “slope” of relation between the command input voltage and motor speed, with Pr3.02. Default is set to Pr3.02=500(r/min)/V, hence input of 6V becomes 3000r/min.

Notice:

1. Do not apply more than $\pm 10V$ to the speed command input (SPR).
2. When you compose a position loop outside of the drive while you use the drive in velocity control mode, the setup of Pr3.02 gives larger variance to the overall servo system.
3. Pay an extra attention to oscillation caused by larger setup of Pr3.02

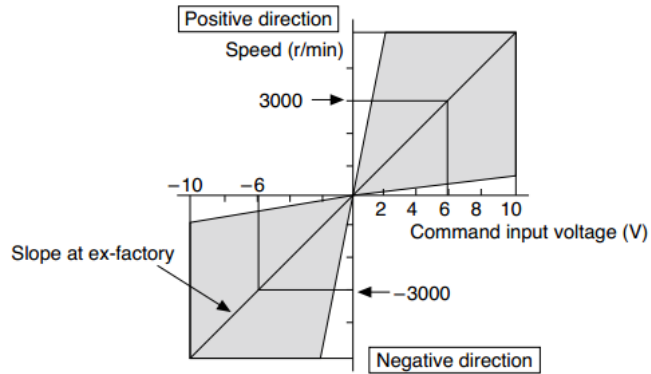

Pr3. 03	Name	Reversal of speed command input		Mode	S	
	Range	0~1	Unit	—	Default	1
	Data Type	16bit	Access	R/W	Address	0307H
	Repower	-				

Specify the polarity of the voltage applied to the analog speed command (SPR).

Setup value	Motor rotating direction	
0	Non-reversal	[+ voltage] → [+ direction] [- voltage] → [-direction]
1	reversal	[+ voltage] → [- direction] [- voltage] → [+direction]

Caution: When you compose the servo drive system with this drive set to velocity control mode and external positioning unit, the motor might perform an abnormal action if the polarity of the speed command signal from the unit and the polarity of this parameter setup does not match.

Pr3. 04	Name	1st speed of speed setup		Mode	S	
	Range	-10000~10000	Unit	r/min	Default	0
	Data Type	16bit	Access	R/W	Address	0309H
	Repower	-				
Pr3. 05	Name	2nd speed of speed setup		Mode	S	
	Range	-10000~10000	Unit	r/min	Default	0
	Data Type	16bit	Access	R/W	Address	030BH
	Repower	-				
Pr3. 06	Name	3rd speed of speed setup		Mode	S	
	Range	-10000~10000	Unit	r/min	Default	0
	Data Type	16bit	Access	R/W	Address	030DH
	Repower	-				
Pr3. 07	Name	4th speed of speed setup		Mode	S	
	Range	-10000~10000	Unit	r/min	Default	0

	Data Type	16bit	Access	R/W	Address	030FH
	Repower	-				
Pr3. 08	Name	5th speed of speed setup			Mode	<input checked="" type="checkbox"/> S
	Range	-10000~10000	Unit	r/min	Default	0
	Data Type	16bit	Access	R/W	Address	0311H
	Repower	-				
Pr3. 09	Name	6th speed of speed setup			Mode	<input checked="" type="checkbox"/> S
	Range	-10000~10000	Unit	r/min	Default	0
	Data Type	16bit	Access	R/W	Address	0313H
	Repower	-				
Pr3. 10	Name	7th speed of speed setup			Mode	<input checked="" type="checkbox"/> S
	Range	-10000~10000	Unit	r/min	Default	0
	Data Type	16bit	Access	R/W	Address	0315H
	Repower	-				
Pr3. 11	Name	8th speed of speed setup			Mode	<input checked="" type="checkbox"/> S
	Range	-10000~10000	Unit	r/min	Default	0
	Data Type	16bit	Access	R/W	Address	0317H
	Repower	-				
Set up internal command speeds, 1st to 8th						

5.3.2 Speed command acceleration and deceleration

On the basis of speed command input, acceleration and deceleration are added as internal speed commands to control the speed. This function can be used when entering the ladder-like speed command and internal speed setting. In addition, the acceleration and deceleration function can also be used when the vibration is reduced by the change of acceleration.

Pr3. 12	Name	time setup acceleration			Mode	<input checked="" type="checkbox"/> S
	Range	0~10000	Unit	Ms/(1000r/min)	Default	100
	Data Type	16bit	Access	R/W	Address	0319H
	Repower	-				
Pr3. 13	Name	time setup deceleration			Mode	<input checked="" type="checkbox"/> S
	Range	0~10000	Unit	Ms/(1000r/min)	Default	100
	Data Type	16bit	Access	R/W	Address	031BH
	Repower	-				
<p>Set up acceleration/deceleration processing time in response to the speed command input. Set the time required for the speed command(stepwise input)to reach 1000r/min to Pr3.12 Acceleration time setup. Also set the time required for the speed command to reach from 1000r/min to 0 r/min, to Pr3.13 Deceleration time setup.</p> <p>Assuming that the target value of the speed command is V_c(r/min), the time required for acceleration/deceleration can be computed from the formula shown below.</p> <p style="text-align: center;">Acceleration time (ms)=$V_c/1000 * Pr3.12 * 1ms$</p> <p style="text-align: center;">Deceleration time (ms)=$V_c/1000 * Pr3.13 * 1ms$</p>						

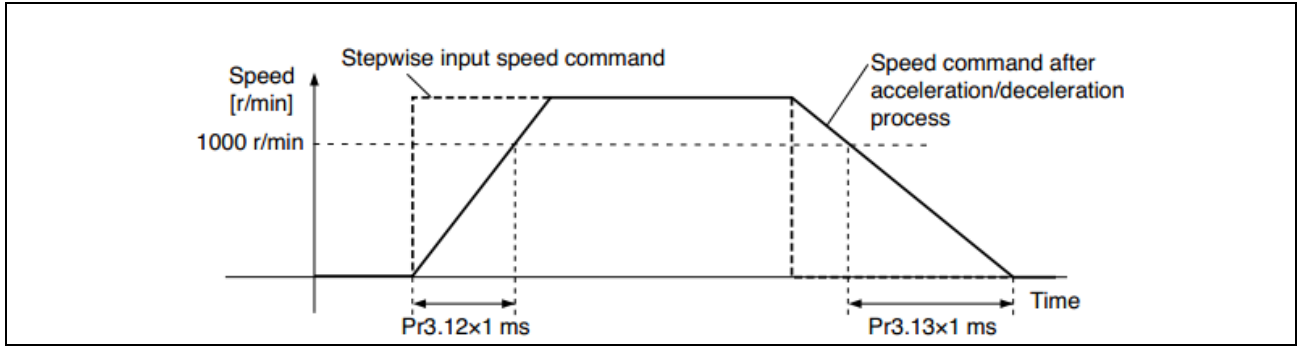

Pr3. 14	Name	Sigmoid acceleration /deceleration time setup		Mode	S	
	Range	0~1000	Unit	Ms	Default	0
	Data Type	16bit	Access	R/W	Address	031DH
	Repower	0				

Set S-curve time for acceleration/deceleration process when the speed command is applied. According to Pr3.12 Acceleration time setup and Pr3.13 Deceleration time setup, set up sigmoid time with time width centering the inflection point of acceleration/deceleration.

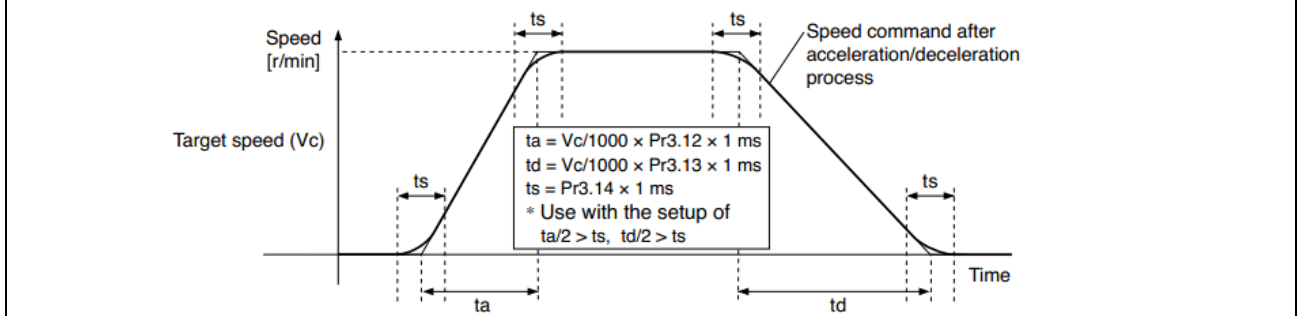

5.3.3 Attained Speed signal AT-SPEED output

When the motor speed reaches the speed set by the parameter PA_436 (setting of arrival speed), the output speed reaches the output (AT-SPEED) signal.

This function can be configured by IO output function parameters, as described in IO Pr4.10 parameters. When the speed meets the set conditions, the set corresponding output IO port can output ON.

Pr4. 36	Name	At-speed(Speed arrival)		Mode	S	
	Range	10~2000	Unit	r/min	Default	1000
	Data Type	16bit	Access	R/W	Address	0449H
	Repower	-				

Set the detection timing of the speed arrival output (AT-SPEED).

When the motor speed exceeds this setup value, the speed arrive output (AT-SPEED) is output. Detection is associated with 10r/min hysteresis .

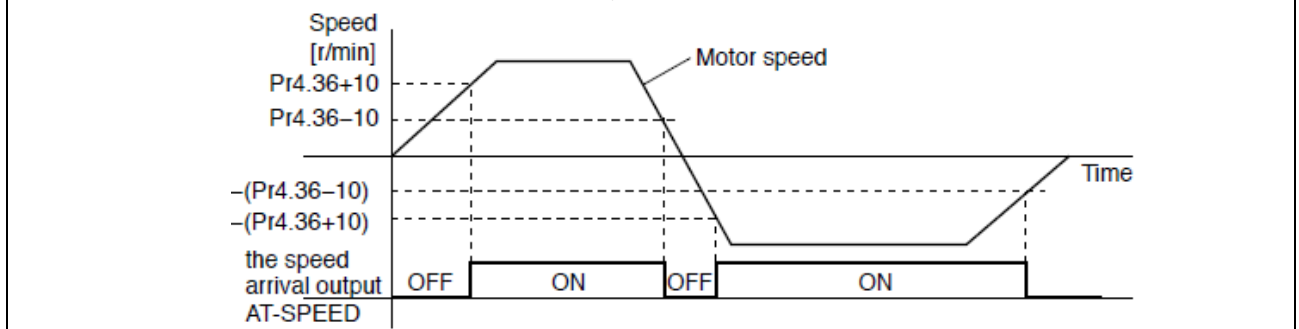

5.3.4 Velocity coincidence output (V-COIN)

When the speed command (before acceleration and deceleration processing) is consistent with the motor speed, the output speed is consistent (V-COIN). If the difference between the speed command and the motor speed before acceleration and deceleration processing in the drive is within the parameter Pr435 (setting the same speed range), it is judged to be consistent.

This function can be configured by IO output function parameters, as described in IO Pr4.10 parameters. When the speed difference meets the setting conditions, the corresponding output IO port set can output ON.

Among them, the in place signal of PV mode is synchronized with the v-coin signal

Pr4. 35	Name	Speed coincidence range			Mode	S
	Range	10~2000	Unit	r/min	Default	50
	Data Type	16bit	Access	R/W	Address	0447H
	Repower	-				

Set the speed coincidence (V-COIN) output detection timing.
Output the speed coincidence (V-COIN) when the difference between the speed command and the motor speed is equal to or smaller than the speed specified by this parameter.

Because the speed coincidence detection is associated with 10 r/min hysteresis, actual detection range is as shown below.

Speed coincidence output OFF -> ON timing (Pr4.35 -10) r/min
Speed coincidence output ON -> OFF timing (Pr4.35 +10) r/min

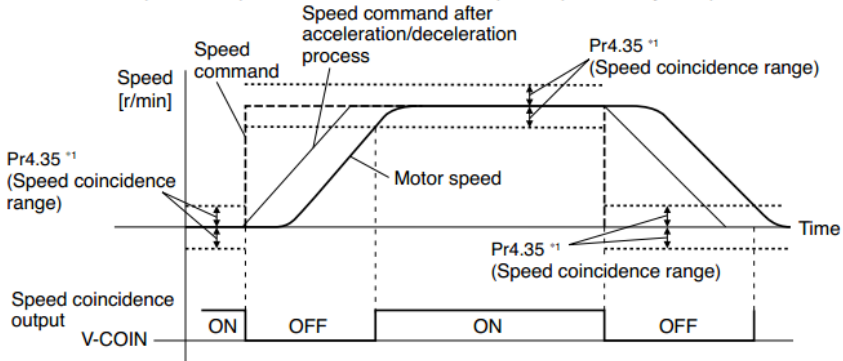

The graph illustrates the V-COIN output logic. The y-axis represents Speed [r/min] and the x-axis represents Time. Three curves are shown: 'Speed command', 'Speed command after acceleration/deceleration process', and 'Motor speed'. The 'Speed command' is a step function. The 'Speed command after acceleration/deceleration process' is a smoothed version of the step. The 'Motor speed' follows the smoothed command with a lag. The 'Speed coincidence range' is defined by Pr4.35. The V-COIN output is ON when the motor speed is within this range of the speed command, and OFF otherwise. The graph shows the output turning ON during acceleration and OFF during deceleration.

5.3.5 Speed zero clamp (ZEROSPD)

You can forcibly set the speed command to 0 by using the speed zero clamp input.

Pr3. 15	Name	Speed zero-clamp function selection			Mode	S
	Range	0~3	Unit	0.1HZ	Default	0
	Data Type	16bit	Access	R/W	Address	031FH
	Repower	-				

- If Pr3.15=0, the function of zero clamp is forbidden. It means the motor rotates with actual velocity which is controlled by the analog voltage input 1 even if the velocity is less than 10 rpm. The motor runs no matter what the value of Pr3.16 is. The actual velocity is controlled by external the analog voltage input .
- If Pr3.15=1 and the input signal of Zero Speed is available in the same time, the function of zero clamp works. It means motor will stop rotating in servo-on condition no matter what the velocity of motor is, and motor stop rotating no matter what the value of Pr3.16 is.
- If Pr3.15=2 , the function of zero clamp belongs to the value of Pr3.16. If the actual velocity is less than the value of Pr3.16, the motor will stop rotating in servo-on condition.

Pr3. 16	Name	Speed zero-clamp level			Mode	S
	Range	10~2000	Unit	r/min	Default	30
	Data Type	16bit	Access	R/W	Address	0321H
	Repower	-				
When analog speed given value under speed control mode less than zero speed clamp level setup, speed command will set to 0 strongly.						

Other setup for DI/DO function

For details of SI input function, refer to Pr4.00 – Pr4.09.

For details of DO output function, refer to Pr4.10 – Pr4.15.

5.4 Torque Control

5.4.1 Torque limit function

The speed limit is one of protective functions used during torque control.

This function regulates the motor speed so that it doesn't exceed the speed limit while the torque is controlled.

Pr3. 20	Name	Torque command input reversal			Mode	T
	Range	0~1	Unit	—	Default	0
	Data Type	16bit	Access	R/W	Address	0329H
	Repower	-				
Set up the polarity of the voltage applied to the analog torque command(TRQR).						
		Setup value	Direction of motor output torque			
		0	Non-reversal [+ voltage] → [+ direction] [- voltage] → [-direction]			
		1	reversal [+ voltage] → [- direction] [- voltage] → [+direction]			

Pr3. 21	Name	Speed limit value 1			Mode	T
	Range	0~10000	Unit	r/min	Default	0
	Data Type	16bit	Access	R/W	Address	032BH
	Repower	-				
Set up the speed limit used for torque control. During the torque controlling, the speed set by the speed limit cannot be exceeded.						

Other setup for DI/DO function

For details of DI input function, refer to Pr400 – Pr409.

For details of DO output function, refer to Pr410 – Pr415.

5.5 Multi-turn absolute encoder

The absolute encoder remember position, When the absolute encoder is used for the first time, user need to move to the home position, and clear the absolute position value of multiple turns through the drive to set the home position. It is unnecessary to return to home position in the future (except for the absolute encoder alarm and other situations). It is recommended that the motor is stationary when reading the position to prevent dynamic data jump.

5.5.1 Parameters setting

Pr0.15	Name	Absolute Encoder Setup			Mode	P	S	T
	Range	0~15	Unit		Default	0		
	Data Type	16bit	Access	R/W	Address	001FH		
	Repower	√						

0: Incremental position mode:
The encoder is used as a incremental encoder, and the position retentive at power failure is not supported.

1: Absolute position linear mode:
The encoder is used as an absolute encoder, and the position retentive at power failure is supported..
It is applicable to the scenario where the travel range of device load is fixed and the encoder multi-turn data dose not overflow.

2: Absolute position rotation mode:
The encoder is used as an absolute encoder, and the position retentive at power failure is supported..
It is mainly applicable to the scenario where the load travel range is not limited and the number of motor single-direction revolution is less than 0~(Pr6.63+1)

5: Clean multi-turn alarm, and open multi-turn absolute function.
It will become 1 when normal clearance, if it's still 5 after 3seconds, please deal with according to 153 alarm processing.

9: Clear multi-turn position and reset multi-turn alarm, open multi-turn absolute function.
It will become 1 when normal clearance, if it's still 9 after 3seconds, please deal with according to 153 alarm processing. Please remember to do mechanical homing.

Notes: Set to 9 after homing process finished and servo disabled. valid after repower.

Pr6.63	Name	Absolute multi-turn position upper bound			Mode	P	S	T
	Range	0~32766	Unit	Rotation	Default	0		
	Data Type	16bit	Access	R/W	Address	067FH		
	Repower	√						

While Pr0.15=2: Absolute position rotation mode:
The encoder is used as an absolute encoder, and the position retentive at power failure is supported..
It is mainly applicable to the scenario where the load travel range is not limited and the number of motor single-direction revolution is less than 0~(Pr6.63+1)

5.5.2 Reading absolute position

1. Steps:

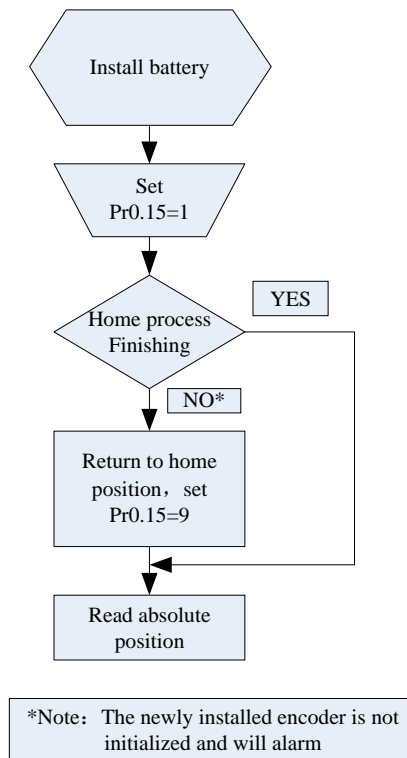

1) Firstly, select the motor with multi-turns absolute encoder which includes battery, and confirm if the drive version supports the function about multi-turns absolute encoder;

2) Set Pr0.15=1 to open absolute encoder. If it is the first time of installation, the drive will alarm Err153. The reason is that the multi-turn position is invalid due to the newly installed battery of the motor. At this time, it is necessary to return to the home position of the machine and perform the multi-turn position reset operation (see multi-turn position reset).

3) When the absolute value origin is set and there is no battery fault, the alarm will be cancelled

4) Finally, the user can read the absolute position, the position will not be lost even if the power is off.

2. Read absolute position

The absolute encoder counting mode :

The number of turns is defined as negative when the motor rotates clockwise, while the number of turns is defined as positive when motor rotates counterclockwise. The maximum rotation number is -32768 to +32767. Once the number of turns is out of range, it will reverse to -32768, -32767...if the number of turns is 32767 counterclockwise ; it will reverse to 32767, 32766... if the number of turns clockwise -32768 .

Absolute encoder read mode: read 6064h data object

3. Clear absolute position

Before clear absolute position, the machine needs to return to the home point. After clear absolute position, the absolute position =0, the single-turn position remains unchanged, and the absolute value of the encoder is cleared to alarm

Set Pr0.15=9: multi-turn zero clearing and reset multi-turn alarm, open multi-turn absolute function. It will become 1 when normal clearance, if it's still 9 after 3seconds, please deal with according to 153 alarm processing. Please remember to do mechanical homing.

5.5.3 Alarm

1. Introductions

The multi-turns absolute encoder alarm function can determine whether the absolute encoder is valid or not, such as battery under voltage or power failure, encoder fault, etc., users can judge the absolute encoder alarm through bus alarm output, IO alarm output, and drive operation panel alarm. At this time, the controller should

stop operation immediately, and the absolute motion operation can only be carried out after the alarm is eliminated

2. Alarm output

Absolute encoder alarm can be displayed by the panel Err153, IO output alarm signal, or read alarm information by communication

3. The drive sends an absolute encoder alarm Err153, the main situation is as follows:

(1) When the absolute encoder is used for the first time, absolute encoder alarm will be generated due to the new battery of the motor. At this time, it is necessary to return to the home point and perform multi-turn zero clearing operation

(2) When the battery under voltage is lower than 3.2v, absolute encoder alarm will be generated by the drive. At this time, the alarm will be automatically eliminated after the battery is recharged by replacing the battery

(3) When the battery voltage is lower than 2.5v, or the battery has a power failure, the absolute encoder alarm will be generated. Even if the battery is replaced, the alarm cannot be eliminated. At this time, the return to the home point and multi-turn zero clearing operation should be performed

4. Alarm processing flow chart

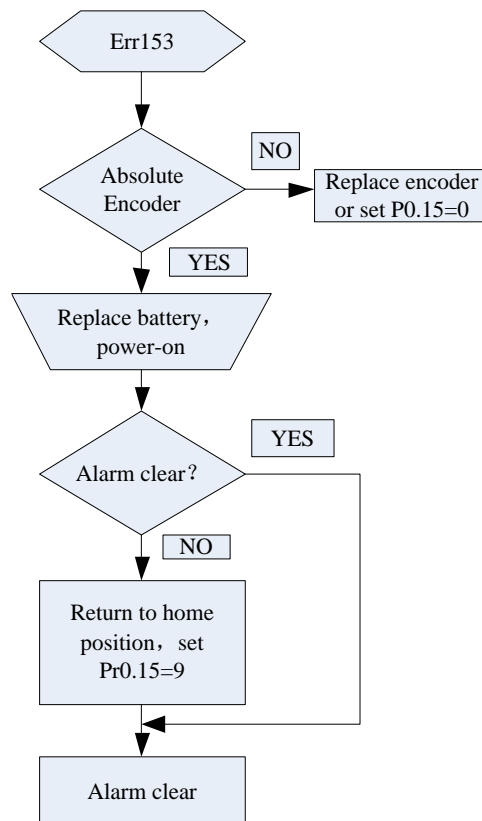

5.6 Security Features

5.6.1 Speed limit

Pr3. 24 *	Name	Motor rotate maximum speed limit			Mode	P	S	T
	Range	0~10000	Unit	r/min	Default	3000		
	Data Type	16bit	Access	R/W	Address	0331H		
	Repower	-						
Set up motor running max rotate speed, but can't be exceeded motor allowed max rotate speed.								

5.6.2 BRK-OFF output

This function can be configured by set digital DO output functions allocation. refer to IO Pr4.10 parameter description. When the enable and time meet the set conditions, the digital output IO port can output ON.

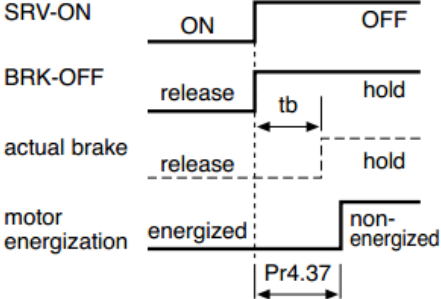
Pr4. 37	Name	Mechanical brake action at stalling setup			Mode	P	S	T
	Range	0~10000	Unit	1ms	Default	0		
	Data Type	16bit	Access	R/W	Address	044BH		
	Repower	-						
<p>Motor brake delay time setup, mainly used to prevent servo on “galloping “phenomenon. Set up the time from when the brake release signal(BRK-OFF) turns off to when the motor is de-energized (servo-free),when the motor turns to servo-off while the motor is at stall</p> <ul style="list-style-type: none"> ● Set up to prevent a micro-travel/drop of the motor (work) due to the action delay time(tb) of the brake. ● After setting up $Pr4.37 \geq tb$, then compose the sequence so as the drive turns to servo-off after the brake is actually activated 								
								

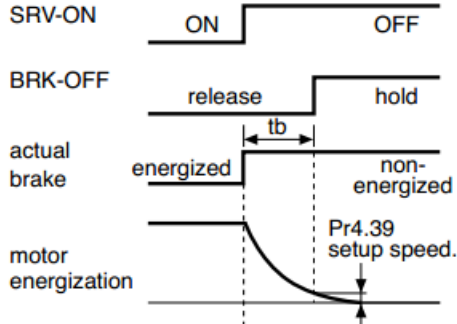
Pr4. 38	Name	Mechanical brake action at running setup			Mode	P	S	T
	Range	0~10000	Unit	1ms	Default	0		
	Data Type	16bit	Access	R/W	Address	044DH		
	Repower	-						
<p>Mechanical brake start delay time setup, it is mainly used to prevent the phenomenon of "Z-axis falling down" when the servo starts up. Mechanical brake start delay time setup, mainly used to prevent servo off “galloping “phenomenon. Set up time from when detecting the off of servo-on input signal(SRV-ON)is to when external brake release signal(BRK-OFF)turns off, while the motor turns to servo off during the motor in motion.</p> <ul style="list-style-type: none"> ● Set up to prevent the brake deterioration due to the motor running. ● At servo-OFF during the motor is running , tb of the right fig will be a shorter one of either Pr4.38 setup time, or time lapse till the motor speed falls below Pr4.39 setup speed. 								
								

Pr4.39	Name	Brake release speed setup			Mode	P	S	T
	Range	30~3000	Unit	1ms	Default	30		
	Data Type	16bit	Access	R/W	Address	044FH		
	Repower	-						
Set up the speed timing of brake output checking during operation .								

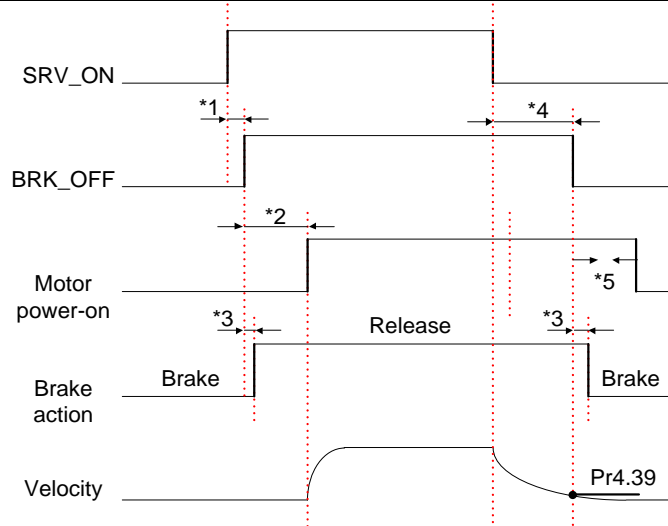

Notice:

- *1: The delay time between SRV_ON and BRK_OFF is less than 500ms;
- *2: Time setting in Pr4.38;
- *3: The delay time between the BRK_OFF signal output and the actual brake release action, which depends on the hardware characteristics of the motor brake;
- *4: The smaller value of Pr4.37 and Pr4.39;

5.6.3 Servo stop mode

Pr5.06	Name	Servo stop mode			Mode	P	S	T
	Range	0~1	Unit	—	Default	0		
	Data Type	16bit	Access	R/W	Address	050DH		
	Repower	-						
Specify the status during deceleration and after stop, after servo-off.								
Setup value		Servo stop mode						
0		When servo-disable signal active, servo-disable after the speed reduced less than Pr4.39						
1		When servo-disable signal active, servo-disable right away, motor in free-run mode.						

5.6.4 Emergency stop function

Pr5.11 *	Name	Torque setup for emergency stop			Mode	P	S	T
	Range	0~500	Unit	%	Default	0		
	Data Type	16bit	Access	R/W	Address	051H		
	Repower	-						
Set up the torque limit at emergency stop When setup value is 0, the torque limit for normal operation is applied.								

5.7 Inertia ratio identification

Pr0.04	Name	Inertia ratio			Mode	P	S	T
	Range	0~10000	Unit	%	Default	250		
	Data Type	16bit	Access	R/W	Address	0009H		
	Repower	-						

You can set up the ratio of the load inertia against the rotor(of the motor)inertia.
Pr0.04=(load inertia/rotate inertia)×100%

Notice:

If the inertia ratio is correctly set, the setup unit of Pr1.01 and Pr1.06 becomes (Hz). When the inertia ratio of Pr0.04 is larger than the actual value, the setup unit of the velocity loop gain becomes larger, and when the inertia ratio of Pr0.04 is smaller than the actual value, the setup unit of the velocity loop gain becomes smaller..

5.7.1 On-line inertia ratio identification

The motor is operated by the controller, and the motor speed is above 400rpm. The running stroke has obvious acceleration, uniform speed and deceleration process, and the load inertia ratio can be tested by running 2-3 times continuously. The inertia ratio of the test is viewed in *Drive Operating Data Monitor-> d16Jr*. Set the monitor value minus 100 into Pr0.04..

5.7.2 Motion Studio inertia ratio identification

This inertia ratio identification function also added in Motion Studio configuration software.

Pre-conditions: 1. Servo disable.
2. Positive and negative limit invalid

Steps:

- Set the Jog speed Pr6.04, and the setting should not be too large(600~1000rpm is recommend)
Set the Acc Pr6.25(50~100 ms/1000rpm is recommend)
Set the Default Inertia Ratio.
- Click "Download" these settings, then **Servo Enable**.
Click "CCW" to run motor to CCW direction, click "Position 1" to save the position limit 1.
Click "CW" to run motor to CW direction, click "Position 2" to save the position limit 2.
Click "Run" to start Inertia ratio identification.
- After finishing, Click "Write" to save the Inertia ratio identification result.

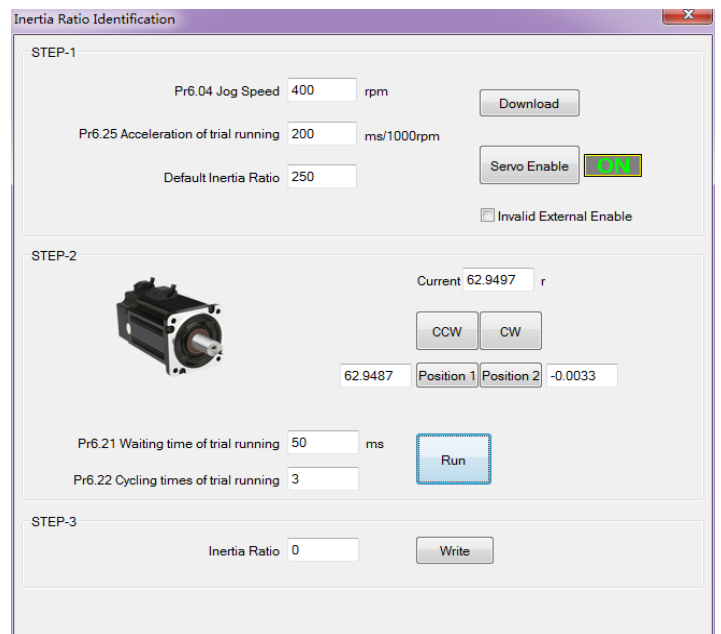

5.8 Vibration Suppression

Specific resonance frequency can be obtained from PC configuration software according to waveform monitoring, and filter frequency can be set to effectively suppress the oscillation ripple of a certain frequency in the current instruction.

The width of the notch is the ratio of the frequency of the notch center at a depth of 0 to the frequency range width of the attenuation rate of -3db.

The depth of the trap is: when the set value is 0, the input of the center frequency is completely disconnected; When the set value is 100, it represents the ratio of input and output that are completely passed

1. Set Pr2.00=1
2. Decrease Pr0.03 to get higher stiffness, higher position loop gain and velocity loop gain. Decrease Pr0.03 gradually, while abnormal sound or oscillation occurred, decrease the current value by 2.
3. Execute movement by controller or Motion Studio, drive will record notch frequency automatically.
4. Upload the drive parameters, the record notch frequency saved in Pr2.07.
Read the value of Pr2.07, and set this value into Pr2.01. Then reset Pr2.07 to 2000.
4. Saving parameters setting.

Pr2.00	Name	Adaptive filter mode setup			Mode	P	S	
	Range	0~4	Unit	—	Default	0		
	Data Type	16bit	Access	R/W	Address	0201H		
	Repower	-						
Set up the resonance frequency to be estimated by the adaptive filter and the special the operation after estimation.								
Setup value		Details						
0	Adaptive filter: invalid	Parameters related to the 3rd and 4th notch filter hold the current value.						
1	Adaptive filter, 1 filter is valid, one time	One adaptive filter is valid, parameters related to the 3rd notch filter will be updated based on adaptive performance. After updated, Pr2.00 returns to 0, stop self-adaptation.						
2	Adaptive filter, 1 filter is valid, It will be valid all the time	One adaptive filter is valid, parameters related to the 3rd notch filter will be updated all the time based on adaptive performance.						
3-4	Reserved	-						

Pr2.01	Name	1st notch frequency			Mode	P	S	T
	Range	50~2000	Unit	Hz	Default	2000		
	Data Type	16bit	Access	R/W	Address	0203H		
	Repower	-						
Set the center frequency of the 1st notch filter Notice: the notch filter function will be invalid by setting up this parameter to “2000”.								
Pr2.02	Name	1st notch width selection			Mode	P	S	T
	Range	0~20	Unit	—	Default	2		
	Data Type	16bit	Access	R/W	Address	0205H		
	Repower	-						
Set the width of notch at the center frequency of the 1st notch filter. Notice: Higher the setup, larger the notch width you can obtain. Use with default setup in normal operation.								

Pr2. 03	Name	1st notch depth selection			Mode	P	S	T
	Range	0~99	Unit	—	Default	0		
	Data Type	16bit	Access	R/W	Address	0207H		
	Repower	-						
Set the depth of notch at the center frequency of the 1st notch filter. Notice: Higher the setup, shallower the notch depth and smaller the phase delay you can obtain.								

Pr2. 04	Name	2nd notch frequency			Mode	P	S	T
	Range	50~2000	Unit	Hz	Default	2000		
	Data Type	16bit	Access	R/W	Address	0209H		
	Repower	-						
Set the center frequency of the 2nd notch filter. Notice: the notch filter function will be invalid by setting up this parameter to “2000”.								

Pr2. 05	Name	2nd notch width selection			Mode	P	S	T
	Range	0~20	Unit	—	Default	2		
	Data Type	16bit	Access	R/W	Address	020BH		
	Repower	-						
Set the width of notch at the center frequency of the 2nd notch filter. Notice: Higher the setup, larger the notch width you can obtain. Use with default setup in normal operation.								

Pr2. 06	Name	2nd notch depth selection			Mode	P	S	T
	Range	0~99	Unit	—	Default	0		
	Data Type	16bit	Access	R/W	Address	020DH		
	Repower	-						
Set the depth of notch at the center frequency of the 2nd notch filter. Notice: Higher the setup, shallower the notch depth and smaller the phase delay you can obtain.								

5.9 Third gain switching

In addition to the conventional switch between the first and second gain, add the third gain switch function to shorten the positioning and setting time.

Pr6.05	Name	Position 3 rd gain valid time			Mode	P		
	Range	0~1000	Unit	0.1ms	Default	0		
	Data Type	16bit	Access	R/W	Address	060BH		
	Repower	-						
Set up the time at which 3 rd gain becomes valid. When not using this parameter, set PR6.05=0, PR6.06=100 This is valid for only position control/full-closed control.								

Pr6.06	Name	Position 3 rd gain multiplication			Mode	P		
	Range	0~1000	Unit	100%	Default	0		
	Data Type	16bit	Access	R/W	Address	060DH		
	Repower	-						
Set up the 3 rd gain by multiplying factor of the 1 st gain 3 rd gain= 1st gain * PR6.06/100.								

This function is only effective for position control. When Pr6.06 is set to non-0 value, the third gain function will be turned on. Pr6.05 is set to specify the value of the third gain. When switching from the second gain to the first gain, there will be a transition from the third gain. The switching time is set as Pr1.19. Take Pr1.15=7(with or without position instruction as the first and second gain of conditional switching) as an example to illustrate the figure below:

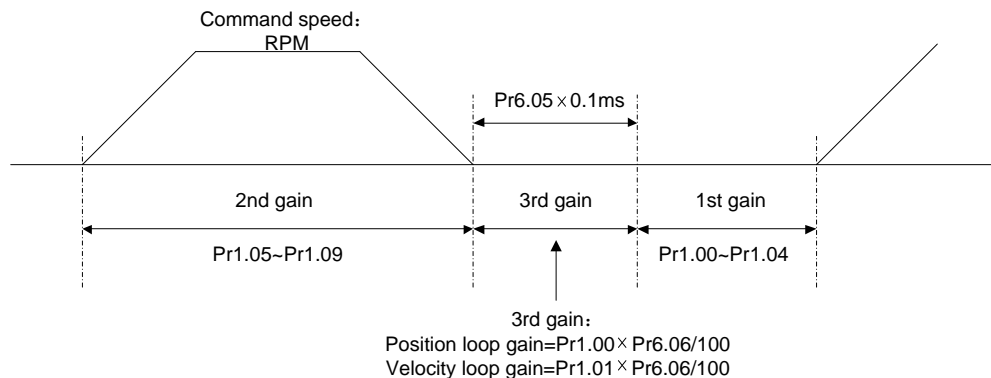

5.10 Friction torque compensation

Pr6.07	Name	Torque command additional value			Mode	P	S	T
	Range	-100~100	Unit	%	Default	0		
	Data Type	16bit	Access	R/W	Address	060FH		
	Repower	-						
Pr6.08	Name	Positive torque compensation value			Mode	P	S	T
	Range	-100~100	Unit	%	Default	0		
	Data Type	16bit	Access	R/W	Address	0611H		
	Repower	-						
Pr6.09	Name	Negative torque compensation value			Mode	P	S	T
	Range	-100~100	Unit	%	Default	0		
	Data Type	16bit	Access	R/W	Address	0613H		
	Repower	-						
This three parameters may apply feed forward torque superposition directly to torque command.								

5.11 Regenerative resistor setting

When the torque of the motor is opposite to the direction of rotation (such as deceleration, z-axis falling down, etc.), energy will be turned back to the drive. At this time, the energy feedback received by the capacitor in the drive, which makes the voltage of the capacitor rising. When it rises to a certain voltage value, the excess energy needs to be consumed by the regenerative resistor.

Pr0.16	Name	External regenerative resistance value			Mode	P	S	T
	Range	10~50	Unit	Ω	Default	100		
	Data Type	16bit	Access	R/W	Address	0021H		
	Repower	-						
Set Pr.0.16 and Pr.0.17 to confirm the threshold value of the discharge loop to give alarm for over current.								

Pr0.17	Name	External regenerative resistance power value			Mode	P	S	T
	Range	0~10000	Unit	W	Default	20		
	Data Type	16bit	Access	R/W	Address	0023H		
	Repower	-						
Set Pr.0.16 and Pr.0.17 to confirm the threshold value of the discharge loop to give alarm for over current.								

Pr7.31	Name	Regenerative resistance control mode setting			Mode	P	S	T
	Range	0~2	Unit	--	Default	0		
		Setup value	Details					
		0	Disable regenerative resistance discharge					
		1	Enable reactive pump lift suppression function					
		2	Enable regenerative resistance discharge					

Pr7.32	Name	Regenerative resistance open threshold setting			Mode	P	S	T
	Range	20~90	Unit	V	Default	80		

The external resistance is activated when the actual bus voltage is higher than Pr7.32 plus Pr7.33 and is deactivated when the actual bus voltage is lower than Pr7.32 minus Pr7.33

Notice:

Pr7.33	Name	Regenerative resistance control hysteresis			Mode	P	S	T
	Range	1~50	Unit	V	Default	5		

The external resistance is activated when the actual bus voltage is higher than Pr7.32 plus Pr7.33 and is deactivated when the actual bus voltage is lower than Pr7.32 minus Pr7.33

Recommendation : leadshine can provide regenerative resistor :

10Ω+/-5%, 100w,

Part number : RXFB-1, Code : 10100469

Chapter6 Pr-Mode

6.1 Overview

PR is uniaxial motion control function which is controlled by procedure software. Mainly uniaxial motion command control, save the motion control function of the controller.

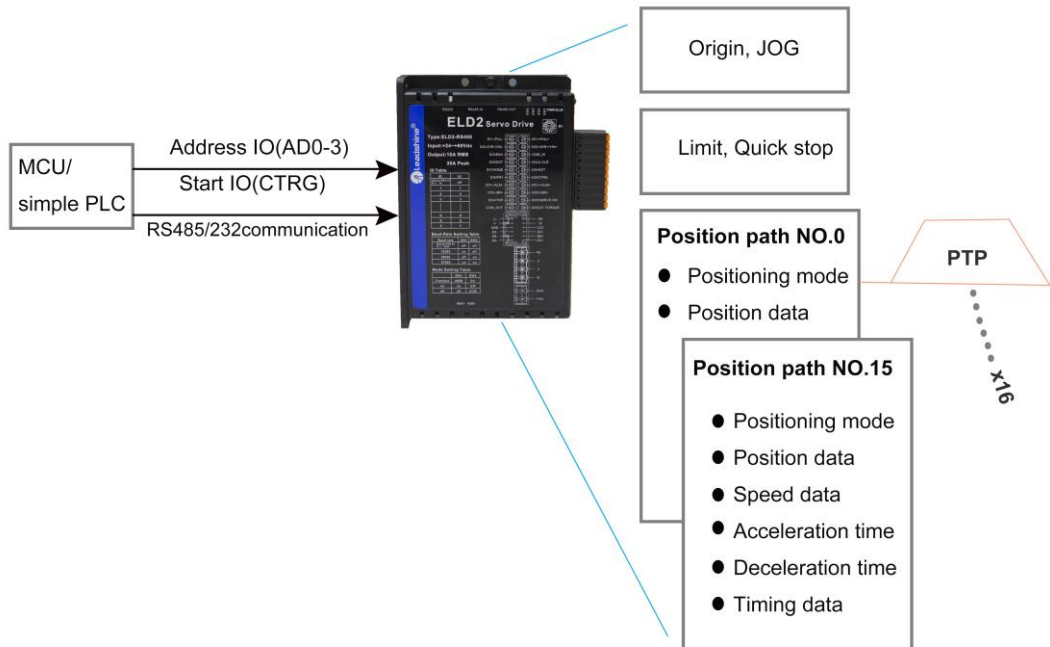

Pr-Mode motion control system

6.1.1 Main function

Main function as below:

PR function	Specification
Homing	Set the homing position by homing process. <ol style="list-style-type: none"> Homing method selectable. Limit switch homing, home switch homing, and manual homing all selectable, Homing direction settable Home deviation position settable. <p>Can be positioned to the specified position after homing.</p> Homing acceleration and deceleration settable <p>Remark: External pulse is unavailable during homing process!</p>
JOG	Execute positive/negative movement by digital input, for debugging. <ol style="list-style-type: none"> Positive move, Negative move JOG speed and acceleration selectable

Position limit	Protect machine by position limit. <ol style="list-style-type: none"> 1. Positive and negative limit switch. 2. Software position limit setting. 3. Position limit deceleration settable. Remark: Software position limit effective after homing process finished.
E-stop	Digital input E-stop signal, stop positioning movement.
Execute movement by digital input	Select 16 motion path by digital input(ADD0~ADD3 allocation to digital input) Execute select motion path by digital input (CTRG allocation to digital input) <ol style="list-style-type: none"> 1. Motion path can be set as position mode, speed mode and homing mode. 2. Digital input rising edge / double edge.. 3. Support continuous positioning 4. Up to 16 motion path 5. Position, speed, acceleration/deceleration are settable. 6. Pause time settable Remark: Double edge trigger only effective for CTRG !
Execute movement by RS485	Execute movement by RS485 communication.

Remark: (1) For PR mode, position command adopt unit: 10000P/r.

(2) PR position control mode for ELD2-RS series, Pr0.01=0.

6.1.2 Installation wiring

RS485 communication terminal:

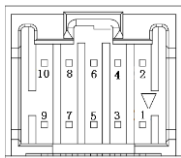
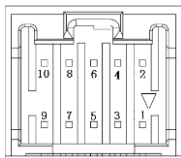
CN6		Pin	Signal	Detail
485 IN		1	RS485+	485data+
		3	RS485-	485 data-
		5	485GND	485 GND
		other	NC	
CN6		Pin	Signal	Detail
485 OUT		1	RS485+	485data+
		3	RS485-	485 data-
		5	485GND	485 GND
		other	NC	

IO terminal wiring and parameter configuration: Newly added IO of PR on the base of standard IO

Relevant parameters:

Parameters	Name	Specification
Pr4.02-Pr4.05	Digital input selection	Specific of the digital input terminals' function distribution, refer to functional allocation table.
Pr4.10-Pr4.12	Digital output selection	Specific of the digital output terminals' function distribution, refer to functional allocation table.

IO terminal functional allocation table:

Input				Output			
Signal name	Symbol	Setup value		Signal name	Symbol	Setup value	
		Normally open	Normally closed			Normally open	Normally closed
Trigger command	CTRG	20h	A0h	Accomplish commands	CMD_OK	20h	A0h
Homing signal	HOME	21h	A1h	Accomplish path	MC_OK	21h	A1h
Forced to stop	STP	22h	A2h	Accomplish homing	HOME_OK	22h	A2h
Positive JOG	JOG+	23h	A3h	Torque limit	TQL	06h	86h
Negative JOG	JOG-	24h	A4h				
Forward limit	PL	25h	A5h				
Reverse limit	NL	26h	A6h				
Home signal	ORG	27h	A7h				
Path address 0	ADD0	28h	A8h				
Path address 1	ADD1	29h	A9h				
Path address 2	ADD2	2ah	Aah				
Path address 3	ADD3	2bh	Abh				
Torque switch	TC-SEL	09h	89h				

Remark: CMD_OK means PR instruction is sent, maybe motor is not yet in place.

MC_OK means PR instruction is sent and motor is in place.

CTRG、HOME is edge triggering, but effective level need to last more than 1ms.

6.2 Pr-Mode Parameters

Pr-Mode parameters contain 8th and 9th parameters, 8th parameters is e-stop and control parameters, 9th parameters is store path table.

6.2.1 8th parameters specification

Parameters	Name	Definition	RS485 address
Pr8.00	Pr control setting	Pr-Mode control function Bit0: 0: CTRG rising edge trigger 1: CTRG double edge trigger Bit1: 0: software limit invalid 1: software limit valid Bit2: 0: not execute homing after power on 1: execute homing after power on Bit3: 0: Absolute encoder function invalid 1: Absolute encoder function valid	0X6000
Pr8.01	Pr motion path number	Up to 16 paths	0X6001
Pr8.02	Control register	Write 0x1P, P path movement Write 0x20, Homing Write 0x21, set current position as homing position Write 0x40, e-stop Read 0x00P, positioning finished, can receive new data Read 0x10P, In operation Read 0x20P, In positioning	0X6002
Pr8.06	Positive software limit H		0X6006
Pr8.07	Positive software limit L		0X6007
Pr8.08	Negative software limit H		0X6008
Pr8.09	Negative software limit L		0X6009
Pr8.10	Homing method	Homing method Bit0: homing direction =0: Negative direction =1: Positive direction. Bit1: Whether go to the set position after homing =0: no =1: yes. Bit2-7: Homing mode 0: homing with limit switch detect 1: homing with homing switch detect 2: homing with single turn Z signal detect 3: homing with torque detect 8: set current position as homing position Bit8: 0: homing process without Z signal detect 1: homing process with Z signal detect	0X600A

Pr8. 11	Homing position H		0X600B
Pr8. 12	Homing position L		0X600C
Pr8. 13	Homing stop positionH		0X600D
Pr8. 14	Homing stop position L		0X600E
Pr8. 15	Homing high speed		0X600F
Pr8. 16	Homing low speed		0X6010
Pr8. 17	Homing acceleration		0X6011
Pr8. 18	Homing deceleration		0X6012
Pr8. 19	Holding time of homing with torque detect		0X6013
Pr8. 20	Torque value of homing with torque detect		0X6014
Pr8. 21	Overpass distance setting while homing		0X6015
Pr8. 22	Deceleration of E-stop while position limit active		0X6016
Pr8. 23	Deceleration of E-stop		0X6017
Pr8. 26	IO combined trigger mode	0: invalid, CTRG signal trigger 1: valid after homing process finished 2: valid without homing process	0X601A
Pr8. 27	IO combined filtering		0X601B
Pr8. 28	Output value of S code		0X601C
Pr8. 29	PR alarm	=0x100: Homing overpass limit switch =0x101: Homing process not complete and stop urgently =0x20x: Path X overpass the limit switch	0X601D
Pr8. 39	JOG speed		0X6027
Pr8. 40	Acceleration of JOG		0X6028
Pr8. 41	Deceleration of JOG		0X6029
Pr8. 42	Command position H		0X602A
Pr8. 43	Command position L		0X602B
Pr8. 44	Motor position H		0X602C
Pr8. 45	Motor position L		0X602D

6.2.2 9th parameters specification

Parameters	Name	Definition	RS485 address
Pr9. 00	Path0 Mode	The motion mode of Path0 motion Bit0-3: TYPE: 0 No Action 1 position mode 2 velocity mode 3 homing mode 4 stop Bit4: INS,	0X6200

		0 do not interrupt 1 interrupt (All interrupt now) Bit5: OVL, 0 do not overlap 1 overlap Bit6-7: 0 absolute position 1 relative to command 2 relative to motor Bit8-13: 0-15 Jump to the corresponding path Bit14: JUMP: 0 do not jump 1 jump	
Pr9.01	Path0 position H		0X6201
Pr9.02	Path0 position L		0X6202
Pr9.03	Path0 speed	rpm	0X6203
Pr9.04	Path0 acceleration	ms/1000rpm	0X6204
Pr9.05	Path0 deceleration	ms/1000rpm	0X6205
Pr9.06	Path0 Pause time	The pause of path, delay time parameter etc,	0X6206
Pr9.07	Special Parameters	Path 0 is mapped to Pr8.02 parameters	0X6207

6.3 Pr-Mode motion control

6.3.1 Homing

Homing method include homing with single turn Z signal detect、homing with limit switch detect、homing with homing switch detect、homing with torque detect、set current position as homing position.

Related parameters:

Parameters	Name	Definition	RS485 address
Pr8.00	Pr control setting	Pr-Mode control function Bit0: 0: CTRG rising edge trigger 1: CTRG double edge trigger Bit1: 0: software limit invalid 1: software limit valid Bit2: 0: not execute homing after power on 1: execute homing after power on Bit3: 0: Absolute encoder function invalid 1: Absolute encoder function valid	0X6000
Pr8.01	Pr motion path number	Up to 16 paths	0X6001
Pr8.02	Control register	Write 0x1P, P path movement Write 0x20, Homing Write 0x21, set current position as homing position Write 0x40, e-stop Read 0x00P, positioning finished, can receive new data Read 0x10P, In operation Read 0x20P, In positioning	0X6002
Pr8.06	Positive software limit H		0X6006
Pr8.07	Positive software limit L		0X6007

Pr8. 08	Negative software limit H		0X6008
Pr8. 09	Negative software limit L		0X6009
Pr8. 10	Homing method	Homing method Bit0: homing direction =0: Negative direction =1: Positive direction. Bit1: Whether go to the set position after homing =0: no =1: yes. Bit2-7: Homing mode 0: homing with limit switch detect 1: homing with homing switch detect 2: homing with single turn Z signal detect 3: homing with torque detect 8: set current position as homing position Bit8: 0: homing process without Z signal detect 1: homing process with Z signal detect	0X600A
Pr8. 11	Homing position H		0X600B
Pr8. 12	Homing position L		0X600C
Pr8. 13	Homing stop positionH		0X600D
Pr8. 14	Homing stop position L		0X600E
Pr8. 15	Homing high speed		0X600F
Pr8. 16	Homing low speed		0X6010
Pr8. 17	Homing acceleration		0X6011
Pr8. 18	Homing deceleration		0X6012
Pr8. 19	Holding time of homing with torque detect		0X6013
Pr8. 20	Torque value of homing with torque detect		0X6014
Pr8. 21	Overpass distance setting while homing		0X6015

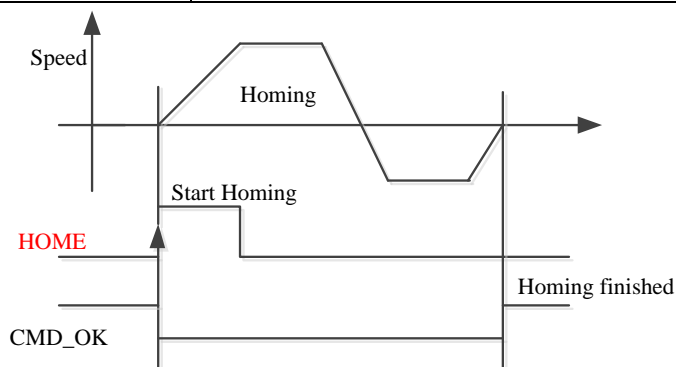

CMD_OK and MC_OK Both of them can be used to represent action is complete , after the signal effective, there will have a delay within 1 ms.

6.3.2 Position limit and E-stop

Position limit and E-stop

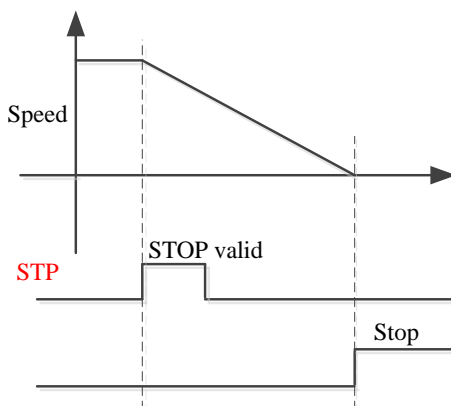

6.3.3 JOG

JOG

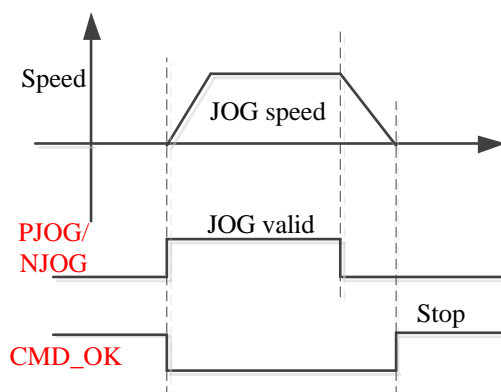

6.3.4 Path Motion

There are three modes of positioning path: Position mode, Velocity mode and homing mode.

Related parameters:

Parameters	Name	Definition	RS485 address
Pr9.00	Path0 Mode	The motion mode of Path0 motion Bit0-3: TYPE: 0 No Action 1 position mode 2 velocity mode 3 homing mode 4 stop Bit4: INS, 0 do not interrupt 1 interrupt (All interrupt now)	0X6200

		Bit5: OVLP, 0 do not overlap 1 overlap Bit6-7: 0 absolute position 1 relative to command 2 relative to motor Bit8-13: 0-15 Jump to the corresponding path Bit14: JUMP: 0 do not jump 1 jump	
Pr9.01	Path0 position H		0X6201
Pr9.02	Path0 position L		0X6202
Pr9.03	Path0 speed	rpm	0X6203
Pr9.04	Path0 acceleration	ms/1000rpm	0X6204
Pr9.05	Path0 deceleration	ms/1000rpm	0X6205
Pr9.06	Path0 Pause time	The pause of path, delay time parameter etc,	0X6206
Pr9.07	Special Parameters	Path 0 is mapped to Pr8.02 parameters	0X6207

6.3.4.1 Single path motion

CTRG rising edge /double edge trigger the motion(Pr8.00), take CTRG rising edge signal to trigger path5 as example:

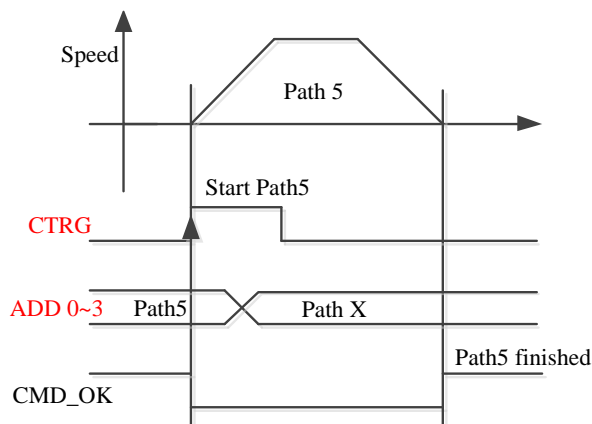

6.3.4.2 Multi path interrupt motion

Interrupt function means a higher path's priority. Interrupt the current valid path, give up the current path and run the new path directly. Similar to the interrupt priority of functions.

Pr9.00 bit4 = 0, interrupt

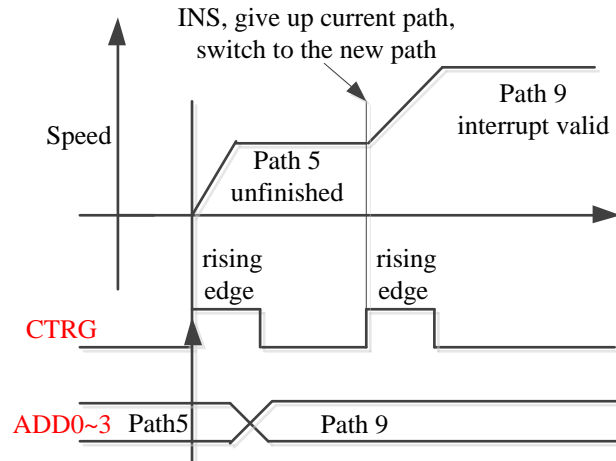

6.3.4.3 Continuous path motion without overlap

After the first path motion finished and pause time delay, start another path motion automatically without trigger signal.

Pr9.00 bit5 = 0, continuous path motion without overlap

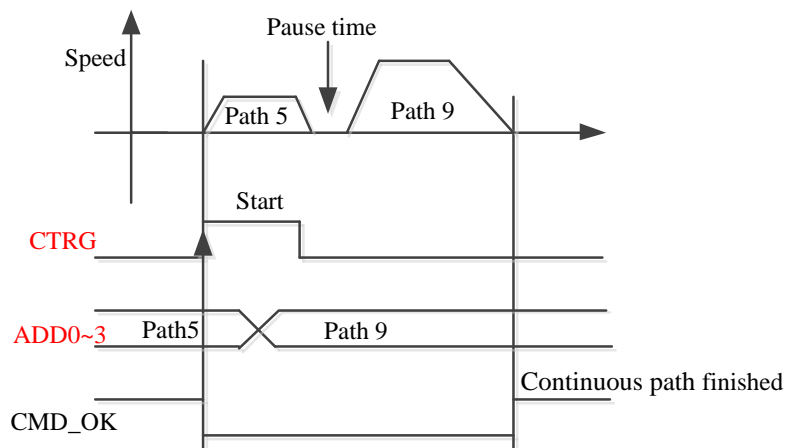

6.3.4.4 Continuous path motion with overlap

During the first path motion in process, start another path motion automatically without trigger signal.

Pr9.00 bit5 = 1, continuous path motion with overlap

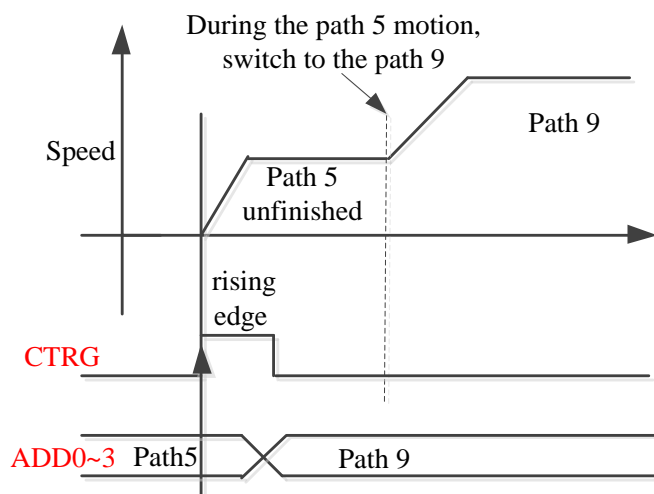

6.4 Execute Movement of Pr-Mode

6.4.1 Execute movement by Configuration software

Configuration software is used for drive parameter setting and save, debugging steps are:

1. Check the wirings.
2. Set the work mode to be PR mode ($Pr0.01=0$), Internal SERVO-enabled ($Pr4.02=83$), set the distribution of IO register Pr4.03-Pr4.13) Confirm the running direction and so on.
3. Setting up the PR basic control parameters through upper computer's "Pr-Mode" interface. Include: trigger setting, software limit, JOG function, homing function, e-stop function and so on.
4. Setting up the PR positioning path parameters in configuration software " Pr-Mode " interface, include:

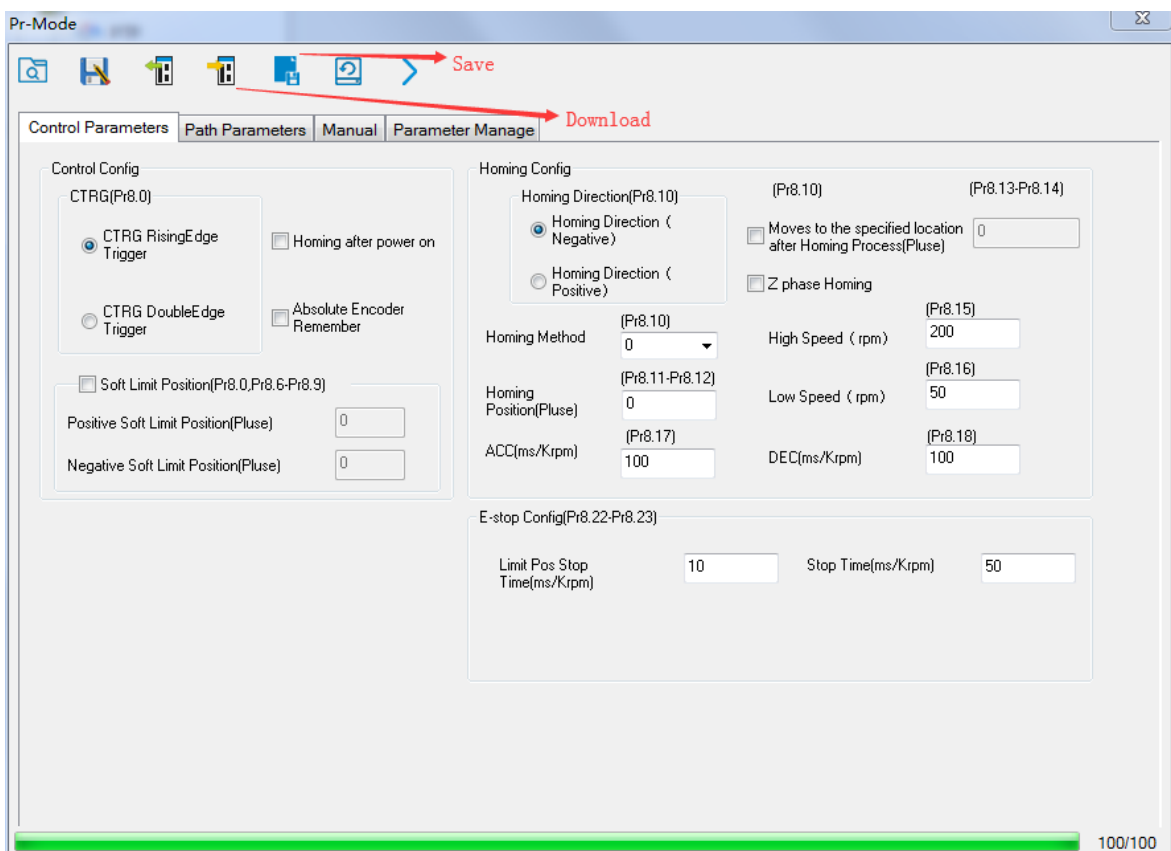

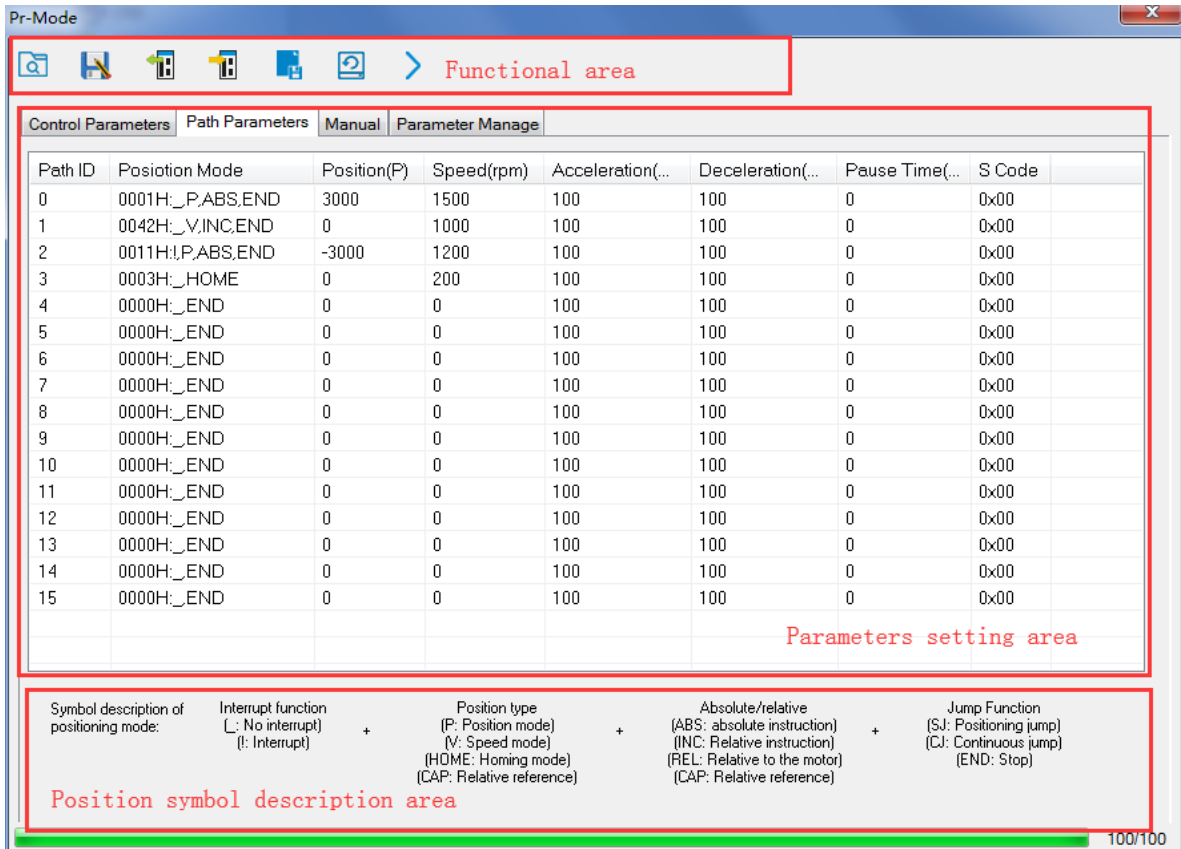

For the convenience of the positioning model expressing, use mnemonic symbol to express, such as:

P , ABS , SJ1 means that path is position addressing, position value is absolute position, jump to No.1 path with delay, and can not interrupt running.

!V , ABS , SJ1 means that path is speed running, jump to No.1 path with delay, and can interrupt running.

HOME means that path is homing movement.

END means that path is E-stop.

5. Test run

After confirming that the parameters are set correctly, the test begins. The interface is shown below

Click the number marked red in the figure and click start to run according to the speed in the path parameter configuration diagram. Click the corresponding number and click to run at the configured speed. If not, check that the parameters are set correctly

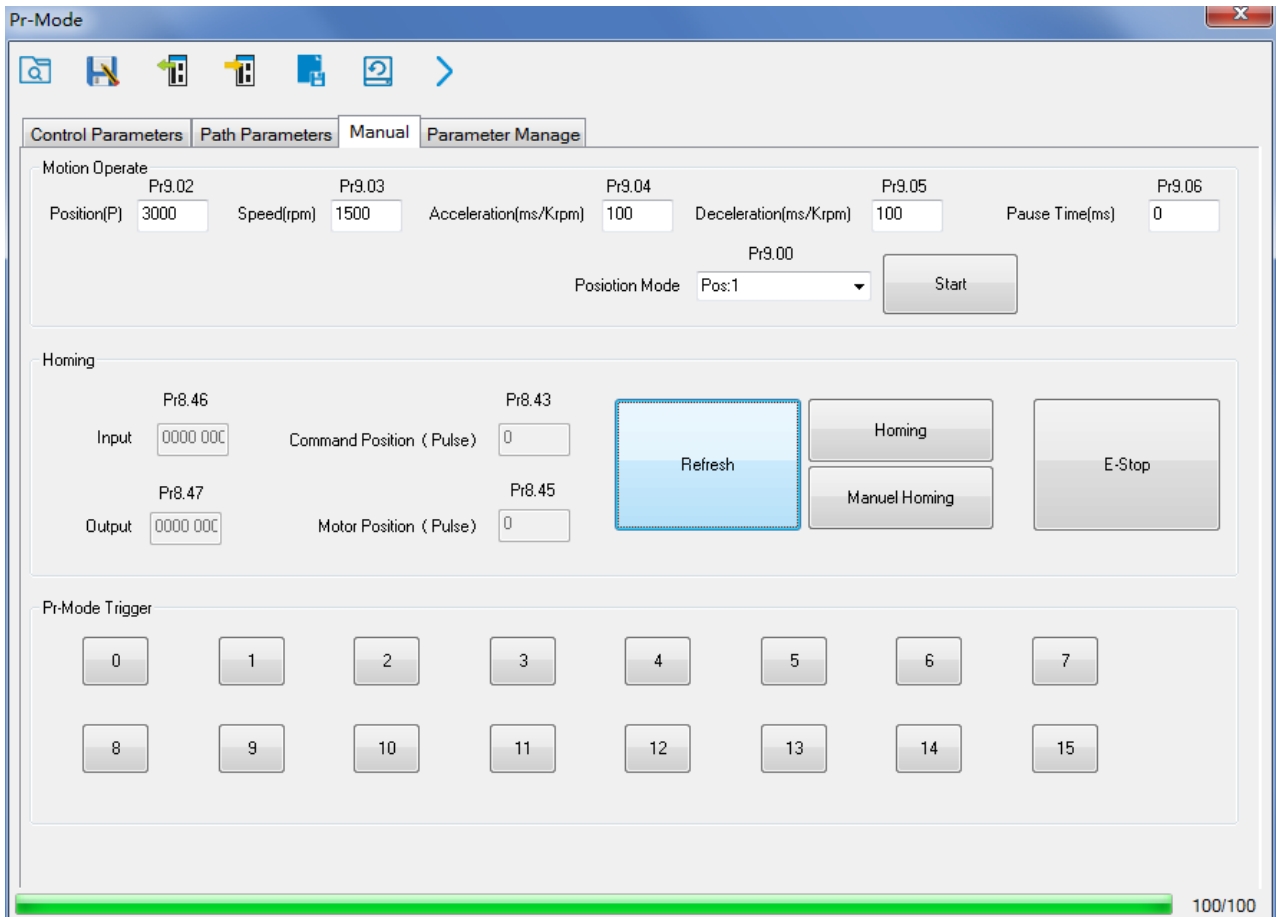

6.4.2 Execute movement by digital signal

Pr-Mode motion can be triggered by IO signal.

Parameters	Name	Specification
Pr4.02-Pr4.05	Digital input selection	Specific of the digital input terminals' function distribution, refer to functional allocation table.
Pr4.10-Pr4.12	Digital output selection	Specific of the digital output terminals' function distribution, refer to functional allocation table.

IO terminal functional allocation table:

Input				Output			
Signal name	Symbol	Setup value		Signal name	Symbol	Setup value	
		Normally open	Normally closed			Normally open	Normally closed
Trigger command	CTRG	20h	A0h	Accomplish commands	CMD_OK	20h	A0h
Homing signal	HOME	21h	A1h	Accomplish path	MC_OK	21h	A1h

Forced to stop	STP	22h	A2h	Accomplish homing	HOME_OK	22h	A2h
Positive JOG	JOG+	23h	A3h	Torque limit	TQL	06h	86h
Negative JOG	JOG-	24h	A4h				
Forward limit	PL	25h	A5h				
Reverse limit	NL	26h	A6h				
Home signal	ORG	27h	A7h				
Path address 0	ADD0	28h	A8h				
Path address 1	ADD1	29h	A9h				
Path address 2	ADD2	2ah	Aah				
Path address 3	ADD3	2bh	Abh				
Torque switch	TC-SEL	09h	89h				

Remark: CMD_OK means PR instruction is sent, maybe motor is not yet in place.

MC_OK means PR instruction is sent and motor is in place.

CTRG、HOME is edge triggering, but effective level need to last more than 1ms.

Execute movement by digital signal

The trigger mode of path motion is divided into edge trigger and IO combination trigger. Determined by control parameter Pr8.26; The edge trigger selects the motion path by the combination of paths, and then triggers the edge event of IO CTRG signal to start a motion. The IO combination trigger means that the combination of IO path select signal is directly used to trigger the motion without IO CTRG signal, the path 0 is invalid. When the IO combination signal turns into a non-zero path, the path will run once triggered after IO filtering. The timing diagram is shown below:

Parameters	Name	Range	Default Value	Definition
Pr8.26	IO combined trigger mode	0~65535	0	0: invalid, CTRG signal trigger 1: valid after homing process finished 2: valid without homing process
Pr8.27	IO combined filtering	0~65535	10	IO combined filtering time

Notes: The path 0 is invalid, so the path 0 cannot be triggered by the IO combined signal, so the IO combined signal will trigger the motion from path 1 to path 15.

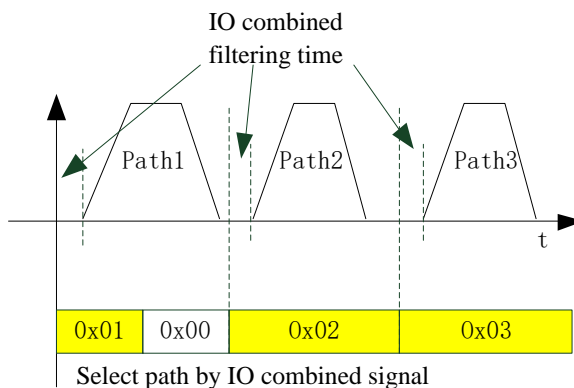

IO combined signal trigger sequence

- Notes 1:** The path 0 is invalid, so the path 0 cannot be triggered by the IO combined signal. If users want to trigger incremental position, the IO combined signal should be as follow:
 Path X IO combined signal → Path 0 IO combined signal → Path Y IO combined signal, trigger incremental position multiple times by these 3 steps.
- Notes 2:** If the IO combined trigger mode=2 (Pr8.26=2), when the drive is powered on, the motion will be triggered while the IO combined signal select path≠0.

6.4.3 Execute movement by RS485 Communication

Communication control mode can realize same function as IO operation, users can modify parameters and trigger action to run, can control more than one drive by field bus, save the wiring and obtain good flexibility. Communications control includes two modes: Fixed trigger mode and immediately trigger mode.

6.4.3.1 Parameters setting

Parameters	Name	Specification																												
Pr0.01	Control Mode Setup	Set Pr0.01=0 for Pr-Mode																												
Pr4.02	DI3 Input selection	Set Pr4.02=83 for internal Servo-Enable Set Pr4.02=03 for external Servo-Enable (Digital input for Servo-Enable)																												
Pr5.29	Mode setup of RS485 communication	<table border="1"> <thead> <tr> <th>Setup Value</th> <th>Data bit</th> <th>Parity-check</th> <th>Stop bit</th> </tr> </thead> <tbody> <tr> <td>0</td> <td>8</td> <td>Even Parity</td> <td>2</td> </tr> <tr> <td>1</td> <td>8</td> <td>Odd Parity</td> <td>2</td> </tr> <tr> <td>2</td> <td>8</td> <td>Even Parity</td> <td>1</td> </tr> <tr> <td>3</td> <td>8</td> <td>Odd Parity</td> <td>1</td> </tr> <tr> <td>4</td> <td>8</td> <td>None</td> <td>1</td> </tr> <tr> <td>5</td> <td>8</td> <td>None</td> <td>2</td> </tr> </tbody> </table>	Setup Value	Data bit	Parity-check	Stop bit	0	8	Even Parity	2	1	8	Odd Parity	2	2	8	Even Parity	1	3	8	Odd Parity	1	4	8	None	1	5	8	None	2
Setup Value	Data bit	Parity-check	Stop bit																											
0	8	Even Parity	2																											
1	8	Odd Parity	2																											
2	8	Even Parity	1																											
3	8	Odd Parity	1																											
4	8	None	1																											
5	8	None	2																											

Pr5.30	Baud rate setup of RS485 communication	<table border="1"> <thead> <tr> <th>Setup value</th> <th>Baud rate</th> <th>Setup value</th> <th>Baud rate</th> </tr> </thead> <tbody> <tr> <td>0</td> <td>2400bps</td> <td>4</td> <td>38400bps</td> </tr> <tr> <td>1</td> <td>4800bps</td> <td>5</td> <td>57600bps</td> </tr> <tr> <td>2</td> <td>9600bps</td> <td>6</td> <td>115200bps</td> </tr> <tr> <td>3</td> <td>19200bps</td> <td></td> <td></td> </tr> </tbody> </table> <p>If SW1 and SW2 OFF, then Pr5.30 valid If SW1 or SW2 ON, then these switches valid in higher priority than Pr5.30</p>	Setup value	Baud rate	Setup value	Baud rate	0	2400bps	4	38400bps	1	4800bps	5	57600bps	2	9600bps	6	115200bps	3	19200bps		
Setup value	Baud rate	Setup value	Baud rate																			
0	2400bps	4	38400bps																			
1	4800bps	5	57600bps																			
2	9600bps	6	115200bps																			
3	19200bps																					
Pr5.31	RS485 slave axis ID	Modbus sub-station address number(Slave ID) If switch S1=0, then Pr5.31 valid. If switch S1=1~F, S1 valid in higher priority than Pr5.31																				
Pr8.02	PR trigger	(16bit, 485 address..0x6002) Write 0x1P, P path movement Write 0x20, Homing Write 0x21, set current position as homing position Write 0x40, e-stop Read 0x00P, positioning finished, can receive new data Read 0x10P, In operation Read 0x20P, In positioning																				

6.4.3.2 Pr-Mode parameters address

8th parameters: $0x6000 + (\text{Parameters NO} - 800)$

The address of Pr8.06: $0x6000 + (806 - 800) = 0x6006$

9th parameters: $0x6200 + (\text{Parameters NO} - 900)$

The address of Pr9.06: $0x6200 + (906 - 900) = 0x6206$

Pr-Mode parameters address

RS485 address	Parameter	Name	Specification
0x6000	Pr8.00	Pr control setting	HEX
0x6002	Pr8.02	Control register	HEX
0x6006	Pr8.06	Positive software limit H	Pulse
0x6007	Pr8.07	Positive software limit L	Pulse
0x6008	Pr8.08	Negative software limit H	Pulse
0x6009	Pr8.09	Negative software limit L	Pulse
0x600a	Pr8.10	Homing method	HEX
0x600c	Pr8.12	Homing position H	Pulse
0x600d	Pr8.13	Homing stop positionH	Pulse
0x600e	Pr8.14	Homing stop position L	Pulse
0x600f	Pr8.15	Homing high speed	r/min
0x6010	Pr8.16	Homing low speed	r/min
0x6011	Pr8.17	Homing acceleration	ms/Krpm
0x6012	Pr8.18	Homing deceleration	ms/Krpm

0x6016	Pr8.22	Deceleration of E-stop while	r/min
0x6017	Pr8.23	Deceleration of E-stop	r/min
0x602a	Pr8.42	Command positionH	Read only
0x602b	Pr8.43	Command positionL	Read only
0x602c	Pr8.44	Motor position H	Read only
0x602d	Pr8.45	Motor position L	Read only
0x602e	Pr8.46	Input IO status	Read only
0x602f	Pr8.47	Output IO status	Read only
	Pr9.00~Pr9.07	Path 0 parameters	
0x6200	Pr9.00	Path0 Mode	HEX
0x6201	Pr9.01	Path0 position H	Pulse
0x6202	Pr9.02	Path0 position L	Pulse
0x6203	Pr9.03	Path0 speed	r/min
0x6204	Pr9.04	Path0 acceleration	ms/Krpm
0x6205	Pr9.05	Path0 deceleration	ms/Krpm
0x6206	Pr9.06	Path0 Pause time	ms
0x6207	Pr9.07	Special Parameters	
0x6208~0x620f	Pr9.08~Pr9.15	Path 1 parameters	
The same with Pr9.00~Pr9.07			
0x6210~0x6217	Pr9.16~Pr9.23	Path 2 parameters	
The same with Pr9.00~Pr9.07			
0x6218~0x621f	Pr9.24~Pr9.31	Path 3 parameters	
The same with Pr9.00~Pr9.07			
0x6220~0x6227	Pr9.32~Pr9.39	Path 4 parameters	
The same with Pr9.00~Pr9.07			
0x6228~0x622f	Pr9.40~Pr9.47	Path 5 parameters	
The same with Pr9.00~Pr9.07			
0x6230~0x6237	Pr9.48~Pr9.55	Path 6 parameters	
The same with Pr9.00~Pr9.07			
0x6238~0x623f	Pr9.56~Pr9.63	Path 7 parameters	
The same with Pr9.00~Pr9.07			
0x6240~0x6247	Pr9.64~Pr9.71	Path 8 parameters	
The same with Pr9.00~Pr9.07			
0x6248~0x624f	Pr9.72~Pr9.79	Path 9 parameters	
The same with Pr9.00~Pr9.07			
0x6250~0x6257	Pr9.80~Pr9.87	Path 10 parameters	
The same with Pr9.00~Pr9.07			
0x6258~0x625f	Pr9.88~Pr9.95	Path 11 parameters	
The same with Pr9.00~Pr9.07			
0x6260~0x6267	Pr9.96~Pr9.103	Path 12 parameters	
The same with Pr9.00~Pr9.07			

0x6268~0x626f	P9.104~Pr9.111	Path 13 parameters	
The same with Pr9.00~Pr9.07			
0x6270~0x6277	Pr9.112-Pr119	Path 14 parameters	
The same with Pr9.00~Pr9.07			
0x6278~0x627f	Pr9.120-Pr127	Path 15 parameters	
The same with Pr9.00~Pr9.07			

6.4.4 Fixed trigger method

Fixed trigger mode: Setup motion parameters. Then, replace CTRG and HOME signal with Pr8.02 (trigger register) to trigger the path. This mode apply to fixed motion and simple operation system.

As below procedure:

1. Firstly, setup homing and path 0~ path 15 which need to run, can transmit parameter configuration temporarily after power on, also can configured to save with upper computer.

2. Enable drive.

3. Implement choice and start of actions by write corresponding instructions into 0x6002 (Pr8.02) .

Write 0x01P, P path motion (write 0x011 to run path 1, write 0x013 to run path 3)

Write 0x020, homing

Write 0x021, set current position as homing position.

Write 0x040, E-stop.

Read 0x000p, means positioning accomplished, can receive new data

Read 0x01P, 0x020, 0x040 means still does not response to instructions.

Read 0x10P, means path is running.

Read 0x200, means instruction accomplished and wait for positioning.

Set path 0 parameters as the table showing , path 1~path15 parameters are the same as path 0

Parameters	Name	Definition	RS485 address
Pr9. 00	Path0 Mode	The motion mode of Path0 motion Bit0-3: TYPE: 0 No Action 1 position mode 2 velocity mode 3 homing mode 4 stop Bit4: INS, 0 do not interrupt 1 interrupt (All interrupt now) Bit5: OVL P, 0 do not overlap 1 overlap Bit6-7: 0 absolute position 1 relative to command 2 relative to motor Bit8-13: 0-15 Jump to the corresponding path Bit14: JUMP: 0 do not jump 1 jump	0X6200

Pr9. 01	Path0 position H		0X6201
Pr9. 02	Path0 position L		0X6202
Pr9. 03	Path0 speed	rpm	0X6203
Pr9. 04	Path0 acceleration	ms/1000rpm	0X6204
Pr9. 05	Path0 deceleration	ms/1000rpm	0X6205
Pr9. 06	Path0 Pause time	The pause of path, delay time parameter etc,	0X6206
Pr9. 07	Special Parameters	Path 0 is mapped to Pr8.02 parameters	0X6207

Set path 1~ path15 as same as path 0 .

Implement choice and start of actions by write corresponding instructions into 0x6002 (Pr8.02), to select which path to run.

6.4.5 Immediately trigger method

Compared with fixed trigger is limited by 16 path, immediately trigger method is more flexible. It is written to the current path at each time, at the same time trigger the operation of this path. Trigger position, speed, homing by a data frame.

This method adopt path0 to implement, path0 has 8 data in total, the last data Pr9.07 mapped to Pr8.02, write 0x10 to Pr8.02 can trigger path0 motion immediately.

As below procedure:

1. Firstly, configure homing and path which need to run, set these parameters by communication or set these parameters and save with upper computer. (homing must be configured)
2. Enable drive.
3. Trigger fixed path by Pr8.02
4. Or write in immediate data into Pr9.00-9.07, set Pr9.07=0x10, implement immediately running path 0.

For example:

Sending orders (Master->Slave)				Return command (Slave->Master)		
1	ID	Sub-station No.	0~31	ID	Sub-station No.	0~31
2	FC	Function code	0x10	FC	Function code	0x10
3	ADDR	Address	0x62	ADDR	Address	0x62
4			0x00			0x00
5	NUM1	Data quantity Word	0x00	NUM	Actually written data quantity	0x00
6			0x08			0x08
7	NUM2	Data quantity Byte	0x10	CRC	check code	L
						H
8-9	Pr9.00	Mode	XXXX			
10-11	Pr9.01	High position	XXXX			
12-13	Pr9.02	Low position	XXXX			
14-15	Pr9.03	Speed	XXXX			
16-17	Pr9.04	Acceleration	XXXX			
18-19	Pr9.05	Deceleration	XXXX			
20-21	Pr9.06	Delay time	XXXX			
22-23	Pr9.07	Trigger control	0x0010			
24	CRC	Check code	L			
25			H			

Please refer to parameter specification for specific data setting.

6.5 Operation Examples

6.5.1 Execute movement by digital signal

Execute movement by digital IO signal.

1、Parameters setting as follows:

Parameters	Name	Specification
Pr0.01	Control Mode Setup	Set Pr0.01=0 for Pr-Mode
Pr4.02	DI3 Input selection	Set Pr4.02=83 for internal Servo-Enable Set Pr4.02=03 for external Servo-Enable (Digital input for Servo-Enable)
Pr4.03-Pr4.08	DI input selection	Specific of the digital input terminals' function distribution, refer to functional allocation table.
Pr4.10-Pr4.15	DO output selection	Specific of the digital output terminals' function distribution, refer to functional allocation table.

2、Setup control parameters, such as: Trigger mode, Homing process, E-stop speed etc. The setting window as follow:

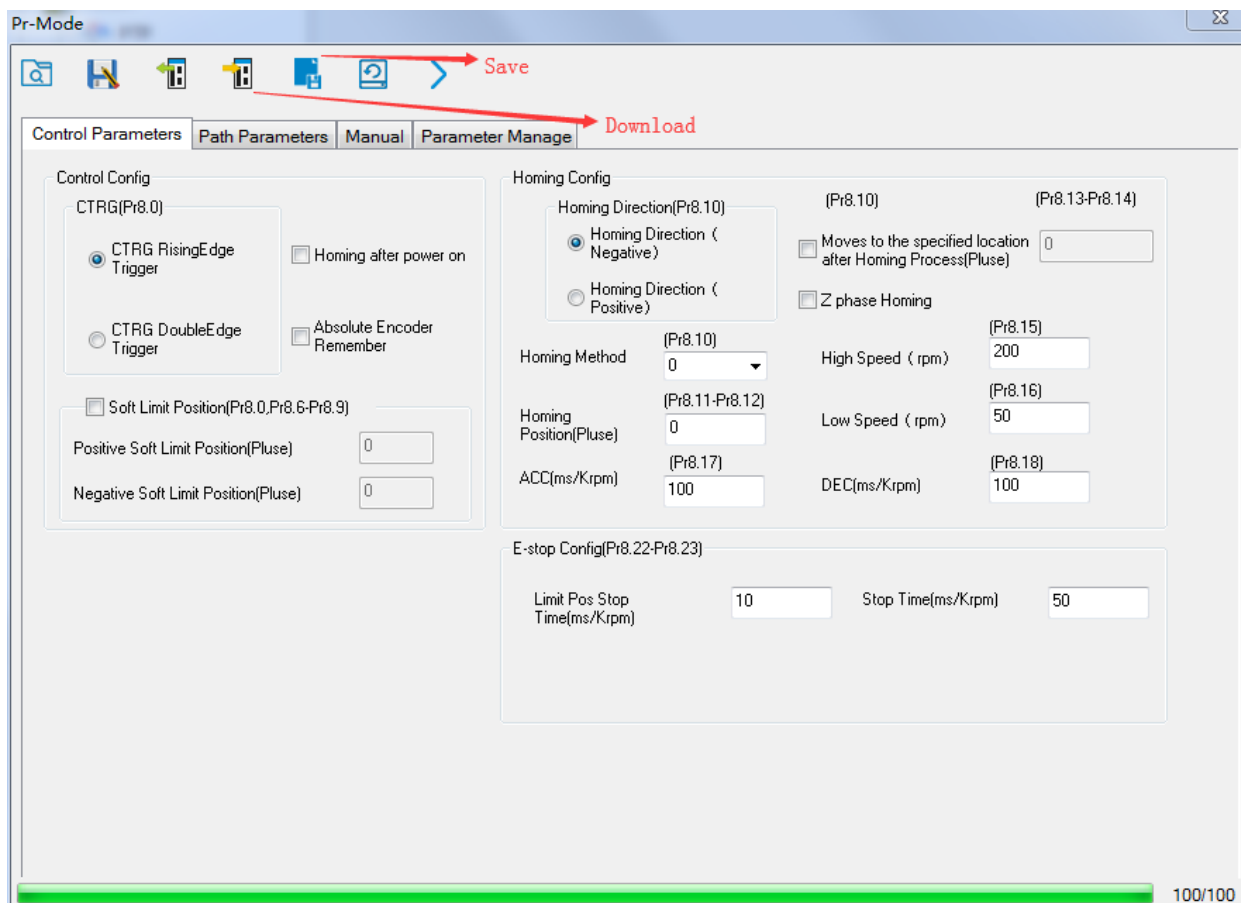

Notes: After the control parameter setting is completed, click the Download button of the toolbar to make the parameters valid. Click Save button to save the parameter to drive permanently.

3、Setup path parameters, such as: Position mode, speed, ACC/DEC, etc.

Functional area: Read file, Upload, Download, Save, etc.

Parameters setting area: Position mode, speed, ACC/DEC, etc.

Position symbol description area: Explains the meaning of the path position symbol.

Notes: After the path parameter setting is completed, click the Download button of the toolbar to make the parameters valid. Click Save button to save the parameter to drive permanently.

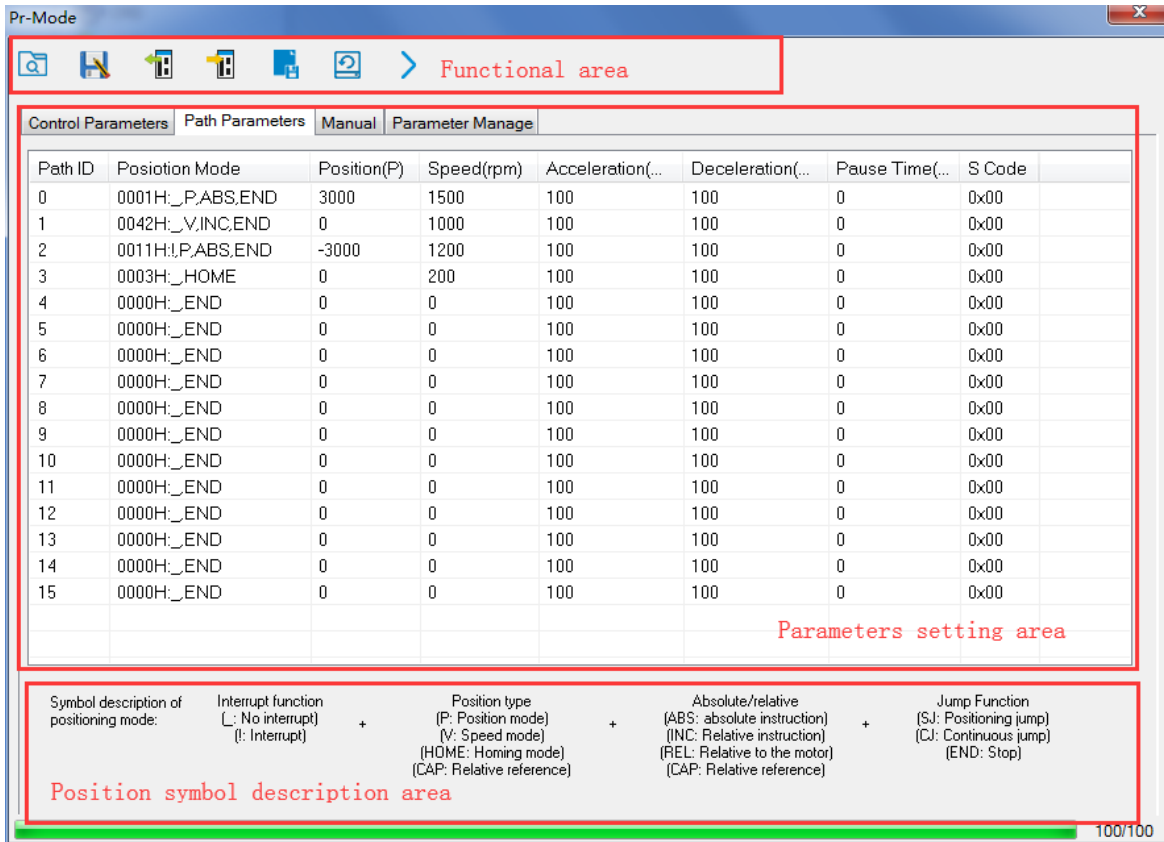

The screenshot shows the 'Pr-Mode' software interface. At the top, there is a toolbar with icons for search, save, download, upload, and refresh, followed by a 'Functional area' label. Below the toolbar is a tabbed interface with 'Control Parameters', 'Path Parameters', 'Manual', and 'Parameter Manage'. The 'Path Parameters' tab is active, displaying a table with 16 rows of path data. Below the table is a 'Parameters setting area' label. At the bottom, there is a 'Position symbol description area' which explains the components of a positioning mode symbol: Interrupt function (L: No interrupt, I: Interrupt), Position type (P: Position mode, V: Speed mode, HOME: Homing mode, CAP: Relative reference), Absolute/relative (ABS: absolute instruction, INC: Relative instruction, REL: Relative to the motor, CAP: Relative reference), and Jump Function (SJ: Positioning jump, CJ: Continuous jump, END: Stop).

Path ID	Position Mode	Position(P)	Speed(rpm)	Acceleration(...)	Deceleration(...)	Pause Time(...)	S Code
0	0001H:_P,ABS,END	3000	1500	100	100	0	0x00
1	0042H:_V,INC,END	0	1000	100	100	0	0x00
2	0011H!:P,ABS,END	-3000	1200	100	100	0	0x00
3	0003H:_HOME	0	200	100	100	0	0x00
4	0000H:_END	0	0	100	100	0	0x00
5	0000H:_END	0	0	100	100	0	0x00
6	0000H:_END	0	0	100	100	0	0x00
7	0000H:_END	0	0	100	100	0	0x00
8	0000H:_END	0	0	100	100	0	0x00
9	0000H:_END	0	0	100	100	0	0x00
10	0000H:_END	0	0	100	100	0	0x00
11	0000H:_END	0	0	100	100	0	0x00
12	0000H:_END	0	0	100	100	0	0x00
13	0000H:_END	0	0	100	100	0	0x00
14	0000H:_END	0	0	100	100	0	0x00
15	0000H:_END	0	0	100	100	0	0x00

Symbol description of positioning mode: [L: No interrupt] + [I: Interrupt] + [P: Position mode] + [V: Speed mode] + [HOME: Homing mode] + [CAP: Relative reference] + [ABS: absolute instruction] + [INC: Relative instruction] + [REL: Relative to the motor] + [CAP: Relative reference] + [SJ: Positioning jump] + [CJ: Continuous jump] + [END: Stop]

4、Debug homing process, path trigger motion, input and output, etc. Its debugging interface is shown as follow:

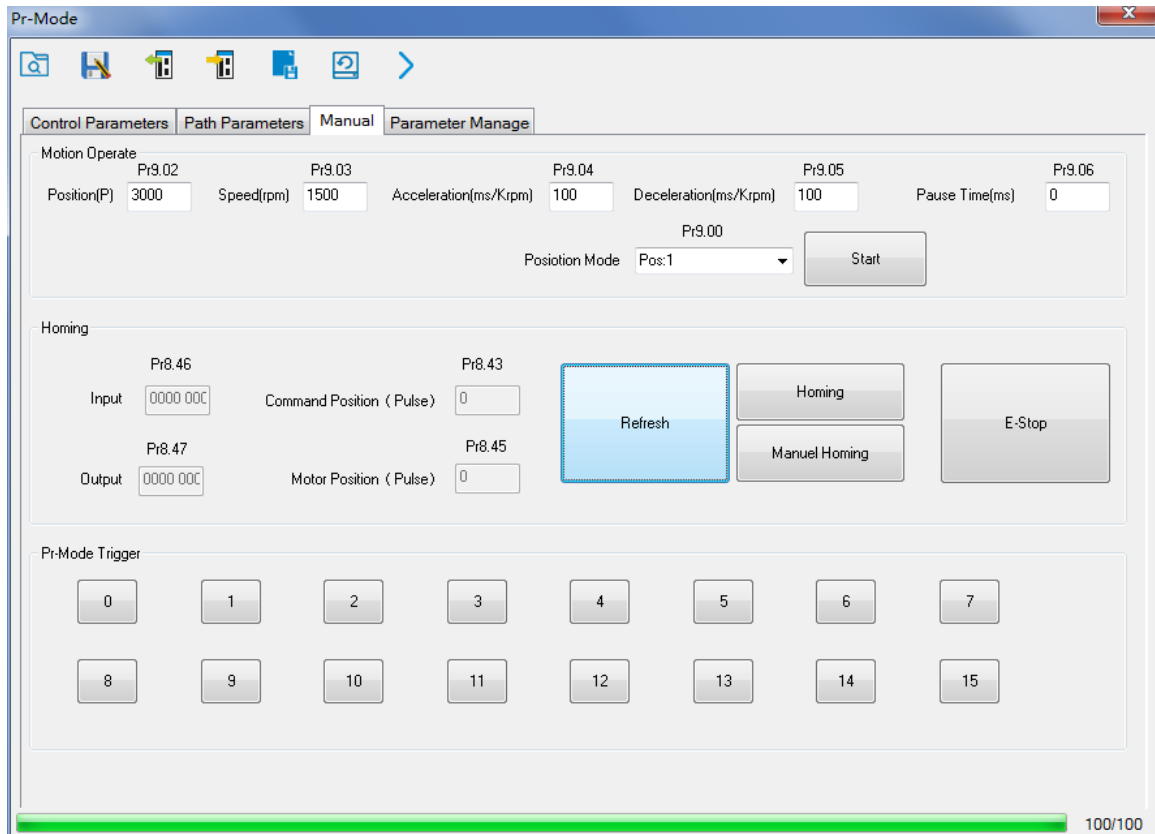

Notes 1: Before using IO CTRG edge signal trigger path motion, select path number by IO combined signal, and then use IO CTRG edge signal to trigger the corresponding path motion

Notes 2: If IO combined trigger mode valid, the IO combined filtering time must be set to ensure that all the IO combined signal changes finished within the filtering time range.

6.5.2 Execute movement by RS485 Communication

6.5.2.1 Write single data 0x06

NO	Send			Receive		
	1	ID	Slave ID	0x01	ID	Slave ID
2	FC	Function code	0x06	FC	Function code	0x06
3	ADDR	Address	H	ADDR	Address	H
4			L			L
5	DATA	Data quantity (Word)	H	DATA	Actually written data quantity	H
6			L			L
7	CRC	Check code	L	CRC	Check code	L
8			H			H

Notes: The number of receive frame is the same as the send frame.

(1) Path 0 (Absolute position mode, 200000pulse, 600rpm, 50ms/1000rpm)

NO	RS485 communication data frame	Details
1	01 06 62 00 00 01 57 B2	Absolute position mode
2	01 06 62 01 00 03 87 B3	200000pulse, 16 bit H
3	01 06 62 02 0D 40 32 D2	200000pulse, 16 bit L
4	01 06 62 03 02 58 66 E8	600rpm

5	01 06 62 04 00 32 56 66	ACC: 50ms/1000rpm
6	01 06 62 05 00 32 07 A6	DEC: 50ms/1000rpm
7	01 06 60 02 00 10 37 C6	Trigger Path0 motion
8	01 06 60 02 00 40 37 FA	E-stop

(2) Path 0 (Relative position mode, 10000pulse, 600rpm, 50ms/1000rpm)

NO	RS485 communication data frame	Details
1	01 06 62 00 00 41 56 42	Relative position mode
2	01 06 62 01 00 00 C7 B2	10000pulse, 16 bit H
3	01 06 62 02 27 10 2D 8E	10000pulse, 16 bit L
4	01 06 62 03 02 58 66 E8	600rpm
5	01 06 62 04 00 32 56 66	ACC: 50ms/1000rpm
6	01 06 62 05 00 32 07 A6	DEC: 50ms/1000rpm
7	01 06 60 02 00 10 37 C6	Trigger Path0 motion
8	01 06 60 02 00 40 37 FA	E-stop

(3) Path 0 (Velocity mode, 600rpm, 50ms/1000rpm)

NO	RS485 communication data frame	Details
1	01 06 62 00 00 02 17 B3	Velocity mode
2	01 06 62 03 02 58 66 E8	600rpm
3	01 06 62 04 00 32 56 66	ACC: 50ms/1000rpm
4	01 06 62 05 00 32 07 A6	DEC: 50ms/1000rpm
5	01 06 60 02 00 10 37 C6	Trigger Path0 motion
6	01 06 60 02 00 40 37 FA	E-stop

(4) Path 1 (Absolute position mode, -200000pulse, 600rpm, 50ms/1000rpm)

NO	RS485 communication data frame	Details
1	01 06 62 08 00 01 D6 70	Absolute position mode
2	01 06 62 09 FF FC 07 C1	-200000pulse, 16 bit H
3	01 06 62 0A F2 C0 F3 40	-200000pulse, 16 bit L
4	01 06 62 0B 02 58 E7 2A	600rpm
5	01 06 62 0C 00 32 D7 A4	ACC: 50ms/1000rpm
6	01 06 62 0D 00 32 86 64	DEC: 50ms/1000rpm
7	01 06 60 02 00 11 F6 06	Trigger Path1 motion
8	01 06 60 02 00 40 37 FA	E-stop

(5) Path 1 (Velocity mode, 300rpm, 50ms/1000rpm)

NO	RS485 communication data frame	Details
1	01 06 62 08 00 02 96 71	Velocity mode
2	01 06 62 0B 01 2C E7 FD	300rpm
3	01 06 62 0C 00 32 D7 A4	ACC: 50ms/1000rpm
4	01 06 62 0D 00 32 86 64	DEC: 50ms/1000rpm
5	01 06 60 02 00 11 F6 06	Trigger Path1 motion

6	01 06 60 02 00 40 37 FA	E-stop
---	-------------------------	--------

(6) Homing

NO	RS485 communication data frame	Details
1	01 06 60 0A 00 00 B7 C8	Homing Method
2	01 06 60 0F 00 64 A6 22	High speed for homing
3	01 06 60 10 00 1E 16 07	Low speed for homing
4	01 06 60 02 00 20 37 D2	Trigger Homing process
5	01 06 60 02 00 40 37 FA	E-stop

6.5.2.2 Write multiple data 0x10

Fixed trigger is limited by 16 segment position, but immediately trigger method is flexible. It is written to the current path at each time, at the same time trigger the operation of this path. Realize position, speed, homing and such actions by a data frame.

This method adopt PR0 to implement, PR0 has 8 data in total, the last data Pr9.07 of it will mapped to Pr8.02, write in 0x10 can trigger Path0 operation immediately, realize data trigger running immediately.

Operating steps:

1. Firstly, configure homing and path which need to run, can power on and send parameter configuration temporarily, also can configure and save with upper computer. (homing must be configured)
2. Servo Enable.

Parameters	Name	Specification
Pr4.02	DI3 Input selection	Set Pr4.02=83 for internal Servo-Enable Set Pr4.02=03 for external Servo-Enable (Digital input for Servo-Enable)

3. Operate fixed path by Pr8.02
4. write in immediate data by Pr9.00-9.07, and Pr9.07=0x10, implement immediately running path 0.

Example of 485 communication data frame operation is shown below:

Sending orders (Master->Slave)				Return command (Slave->Master)		
1	ID	Sub-station No.	0~31	ID	Sub-station No.	0~31
2	FC	Function code	0x10	FC	Function code	0x10
3	ADDR	Address	0x62	ADDR	Address	0x62
4			0x00			0x00
5	NUM1	Data quantity Word	0x00	NUM	Actually written data quantity	0x00
6			0x08			0x08
7	NUM2	Data quantity Byte	0x10	CRC	check code	L
						H
8-9	P9.00	Mode	XXXX			
10-11	P9.01	High position	XXXX			
12-13	P9.02	Low position	XXXX			
14-15	P9.03	Speed	XXXX			
16-17	P9.04	Acceleration	XXXX			
18-19	P9.05	Deceleration	XXXX			

20-21	P9.06	Delay time	XXXX			
22-23	P9.07	Trigger control	0x0010			
24	CRC	Check code	L			
25			H			

Absolute position mode: 01 10 62 00 00 08 10 00 01 00 01 86 A0 01 F4 00 64 00 64 00 00 00 10 AA BF

01 slave ID 01

10 function code, write multi data

62 00 first address mapped to Pr9.00

00 08 8 consecutive operating addresses from 62 00 to 62 07, mapped to Pr9.00~Pr9.07

10 Hexadecimal data of the number of data, 8 register, each address data is divided into high and low bits, $8 \times 2 = 16$

00 01 data written down to the first addresses of 6200 mapped to Pr9.00.

Motion Mode, absolute position mode

00 01 86 A0 data written down to the second and third addresses of 6201 mapped to Pr9.01; 6202 mapped to Pr9.02.

Hexadecimal data of position=100000plus. All positions in PR mode are in units of 10000P/r, 00 01 86 A0 represents 10 turns of motor rotation.

01 F4 data written down to the 4th addresses of 6203 mapped to Pr9.03

Hexadecimal data of Speed=500r/min

00 64 data written down to the 5th addresses of 6204 mapped to Pr9.04

Hexadecimal data of acceleration time=100ms

00 64 data written down to the 6th addresses of 6205 mapped to Pr9.05

Hexadecimal data of deceleration time=100ms

00 00 data written down to the 7th addresses of 6206 mapped to Pr9.06

Hexadecimal data of the delay time=0ms

00 10 data written down to the 8th addresses of 6207 mapped to Pr9.07, to trigger the action, immediately trigger method (1P, Immediately trigger path P)

AA BF the verification code, do not have to directly input, click the corresponding send area verification button automatically generated

The final analysis is as follows: speed is 500r/min, acceleration and deceleration time is 100ms, and the position of absolute positioning is 10 rotations.

01 10 62 00 00 08 10 00 01 00 00 00 00 01 F4 00 64 00 64 00 00 00 10 A0 4A

The final analysis was performed at a speed of 500r/min, acceleration and deceleration time of 100ms, and the position of absolute positioning 0 rotations.

Relative position mode: 01 10 62 00 00 08 10 00 41 00 01 86 A0 01 F4 00 64 00 64 00 00 00 10 EA 8F

01 slave ID 01

10 function code, write multi data

62 00 first address mapped to Pr9.00

00 08 8 consecutive operating addresses from 62 00 to 62 07, mapped to Pr9.00~Pr9.07

10 Hexadecimal data of the number of data, 8 register, each address data is divided into high and low

bits, $8 \times 2 = 16$

- 00 41** data written down to the first addresses of 6200 mapped to Pr9.00.
Motion Mode, relative position mode
- 00 01 86 A0** data written down to the second and third addresses of 6201 mapped to Pr9.01; 6202 mapped to Pr9.02.
Hexadecimal data of position=100000plus. All positions in PR mode are in units of 10000P/r, 00 01 86 A0 represents 10 turns of motor rotation.
- 01 F4** data written down to the 4th addresses of 6203 mapped to Pr9.03
Hexadecimal data of Speed=500r/min
- 00 64** data written down to the 5th addresses of 6204 mapped to Pr9.04
Hexadecimal data of acceleration time=100ms
- 00 64** data written down to the 6th addresses of 6205 mapped to Pr9.05
Hexadecimal data of deceleration time=100ms
- 00 00** data written down to the 7th addresses of 6206 mapped to Pr9.06
Hexadecimal data of the delay time=0ms
- 00 10** data written down to the 8th addresses of 6207 mapped to Pr9.07, to trigger the action, immediately trigger method (1P, Immediately trigger path P)
- EA 8F** the verification code, do not have to directly input, click the corresponding send area verification button automatically generated

The final analysis is as follows: speed is 500r/min, acceleration and deceleration time is 100ms, and the position of relative positioning is 10 rotations.

Homing mode: 01 06 60 02 00 21 F6 12 (Back to origin high-speed, low-speed, and back to zero mode can be set in the eighth set of parameters, using default values this time)

Caution: In Pr mode, the origin induction switch is connected to the drive, which is different from the impulse control. Limited by conditions, only the current position can be demonstrated to the customer: Write 0x021, The current location manually set to zero.

The frame format function is:

- 01** slave ID 01
- 06** function code, write single data

NO	Send			Receive		
	1	ID	Slave ID		ID	Slave ID
2	FC	Function code		FC	Function code	
3	ADDR	Address	H	ADDR	Address	H
4			L			L
5	DATA	Data quantity (Word)	H	DATA	Actually written data quantity	H
6			L			L
7	CRC	check code	L	CRC	check code	L
8			H			H

- 60 02** register address, mapped to Pr8.02
- 00 21** the data write into the register, Write 0x021, The current location manually set to zero.
Write 0x01P, P section positioning
Write 0x020, homing
Write 0x021, set current position as homing point

Write 0x040, e-stop

F6 12 the verification code, do not have to directly input, click the corresponding send area verification button automatically generated

After the current position is set to zero manually, you can click absolute positioning again to send it manually, indicating that the current position is set to zero manually

JOG is IO input, there is no communication control method, you can push users to write relative positioning data in real time, and trigger inching motion immediately instead.

Velocity mode: 0110 62 00 00 08 10 00 02 00 00 00 00 03 E8 00 64 00 64 00 00 00 10 DA 41

01 slave ID 01

10 function code, write multi data

62 00 first address mapped to Pr9.00

00 08 8 consecutive operating addresses from 62 00 to 62 07, mapped to Pr9.00~Pr9.07

10 Hexadecimal data of the number of data, 8 register, each address data is divided into high and low bits, $8*2=16$

00 02 data written down to the first addresses of 6200 mapped to Pr9.00, speed mode

00 00 00 00 data written down to the second and third addresses of 6201 mapped to Pr9.01; 6202 mapped to Pr9.02. Hexadecimal data of position=0plus. All positions in PR mode are in units of 10000P/r, , 00 00 00 00 represents 0 turns of motor rotation in Speed mode

03 E8 data written down to the fourth addresses of 6203 mapped to Pr9.03
Hexadecimal data of Speed=1000r/min

00 64 data written down to the five addresses of 6204 mapped to Pr9.04
Hexadecimal data of acceleration time=100ms

00 64 data written down to the six addresses of 6205 mapped to Pr9.05
Hexadecimal data of deceleration time=100ms

00 00 data written down to the seven addresses of 6206 mapped to Pr9.06
Hexadecimal data of the delay time=0ms

00 10 data written down to the eight addresses of 6207 mapped to Pr9.07 , to trigger the action, Immediately trigger method (1P, Immediately trigger path-P, The sample Pr9.00~9.07 is the positioning related data of path-0)

DA 41 the verification code, do not have to directly input, click the corresponding send area verification button automatically generated

The final analysis is as follows: speed=1000r/min, acceleration and deceleration time is 100ms, velocitymode

E-stop: 01 06 60 02 00 40 37 FA

Chapter 7 Alarm and Processing

7.1 Alarm List

If an error has occurred, the red power LED will flash in a 5s cycle. When the fault is cleared the red power LED is always off.

The following table shows the meaning of the error numbers.

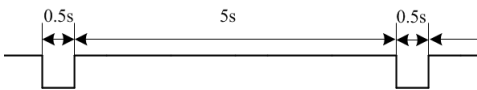
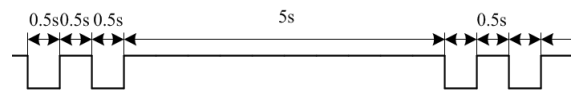
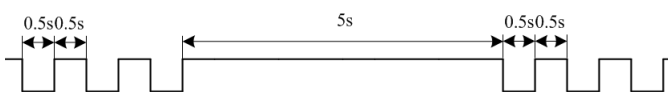
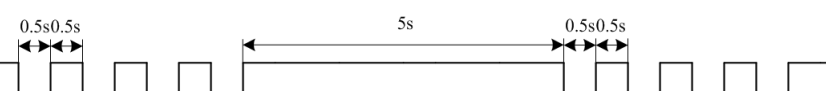
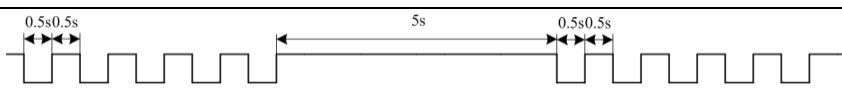
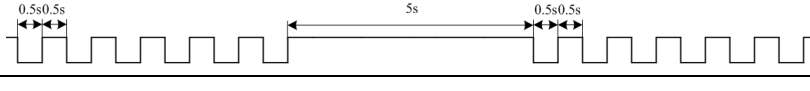
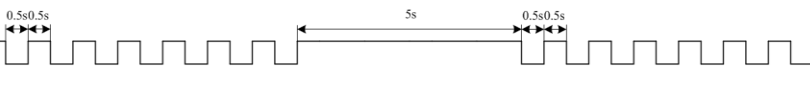
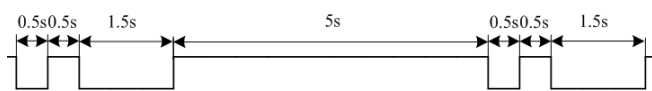
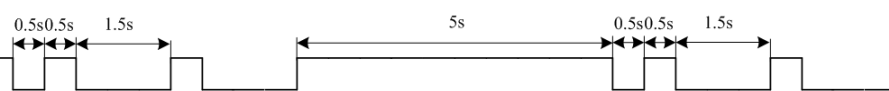
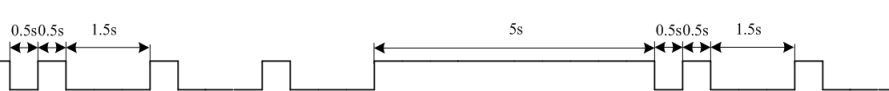
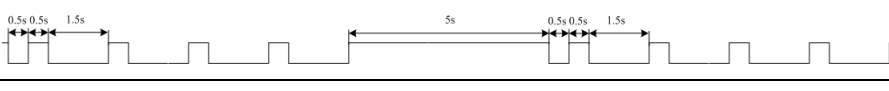
LED flashes	Time sequence	Errors
1 short		Over-current
2 short		DC bus over-voltage/ under-voltage
3 short		CAN communication timeout
4 short		Power line break
5 short		Encoder error
6 short		Over-load
7 short		Too large position pulse deviation
1 short 1 long		Motor speed out of control
1 short 2 long		current detection circuit error
1 short 3 long		CRC verification error
1 short 4 long		Other errors

The configuration software MotionStudio will automatically display the error code in alarm display window.

The history of the error can be also viewed on alarm window from the configuration software.

Table 5.1 Error Code List

Error code		Content	Attribute		
Main	Sub		History	Immediate stop	Can be cleared
09	0~8	FPGA communication error	•		
0A	0~1	Current detection circuit error	•		
	2~4	Analog input circuit error	•		
	3	Power line break	•		
	5	DC bus circuit error	•		
	6	Temperature detection circuit error	•		
0B	0	Control power under-voltage	•		
0C	0	DC bus over-voltage	•		•
0D	0	DC bus under-voltage	•		•
0E	0	Over-current	•		
	1	over -current of intelligent power module(IPM)	•		
0F	0	Driver over-heat	•	•	
10	0	Motor over-load	•		•
	1	Motor overload/driver overload			
12	0	Resistor discharged circuit overload	•	•	
	1	over -current of intelligent power module(IPM)			
15	0	Encoder wiring error	•		
	1	Encoder communication error			
	2	Encoder initial position error	•		
18	0	Encoder data error	•	•	
1A	0	Too large position pulse deviation	•	•	•
	1	Too large velocity deviation	•	•	•
19	0	Excessive vibration	•	•	•
1B	0	Over-speed 1	•	•	•
	1	Motor speed out of control			
16	1	Electronic gear ratio error			
20	0	I/F input interface allocation error	•		•
	1	I/F input interface function set error	•		•
	2	I/F output interface function set error	•		•

29	0	CRC verification error when EEPROM parameter saved			
26	0	Positive/negative over-range input valid	•	•	•
27	0	Analog value 1 input error limit			
58	0	Compulsory alarm input valid	•	•	
5E	0	Motor code error			

Save: save this error history record

Emergency: error, driver will stop immediately

May remove: may through SI input/panel/software ACH Series remove alarm

6.2 Alarm Processing Method

When appear error, please clear error reason, renew power on

Error code	Main	Extra	Display: "E28090"_"E2809F"
	09	0~F	Content: FPGA communication error
Cause		Confirmation	Solution
Vdc/GND under-voltage		Check the voltage of Vdc/GND terminal	Make sure voltage of Vdc/GND in proper range
Driver internal fault		/	replace the driver with a new one

Error code	Main	Extra	Display: 'E28080'_"E28083"
	0A	0~3	Content: current detection circuit error
Cause		Confirmation	Solution
Wiring error of motor output U,V,W terminal		Check wiring of motor output U,V,W terminal	Make sure motor U,V,W terminal wiring correctly
Vdc/GND under-voltage		Check the voltage of Vdc/GND terminal	Make sure voltage of Vdc/GND in proper range
Driver inner fault		/	replace the driver with a new one

Error code	Main	Extra	Display: "E280A2"_"E280A4"
	0A	2~4	Content: analog input circuit error
Cause		Confirmation	Solution
Analog input Wiring error		Check wiring of analog input	Make sure analog input wiring correctly
Driver inner fault		/	replace the driver with a new one

Error code	Main	Extra	Display: "E280A3"
	0A	3	Content: Power line break

Cause	Confirmation	Solution
Power line break	Check wiring of analog input	Use a multimeter to measure the resistance between the winding wires. If the three-phase resistance is inconsistent, the winding may be open or the motor may be damaged
Driver inner fault	/	replace the motor with a new one

Error code	Main	Extra	Display: "E280A5"
	0A	5	Content: DC bus circuit error
Cause		Confirmation	Solution
Vdc/GND under-voltage		Check the voltage of Vdc/GND terminal	Make sure voltage of Vdc/GND in proper range
Driver inner fault		/	replace the driver with a new one

Error code	Main	Extra	Display: "E280A6"
	0A	6	Content: temperature detection circuit error
Cause		Confirmation	Solution
Vdc/GND under-voltage		Check the voltage of Vdc/GND terminal	Make sure voltage of Vdc/GND in proper range
Driver inner fault		/	replace the driver with a new one

Error code	Main	Extra	Display: "E280B0"
	0B	0	Content: control power under-voltage
Cause		Confirmation	Solution
Vdc/GND under-voltage		Check the voltage of Vdc/GND terminal	Make sure voltage of Vdc/GND in proper range
Driver inner fault		/	replace the driver with a new one

Error code	Main	Extra	Display: "E280E0"
	0E	0	Content: DC bus over-voltage
Cause		Confirmation	Solution
Vdc/GND over-voltage		Check the voltage of Vdc/GND terminal	Make sure voltage of Vdc/GND in proper range
Inner brake circuit damaged		/	replace the driver with a new one
Driver inner fault		/	replace the driver with a new one

Error code	Main	Extra	Display: "E280E0"
	0E	0	Content: DC bus under-voltage
Cause		Confirmation	Solution
Vdc/GND under-voltage		Check the voltage of Vdc/GND terminal	Make sure voltage of Vdc/GND in proper range

Driver inner fault	/	replace the driver with a new one
--------------------	---	-----------------------------------

Error code	Main	Extra	Display: "EE0000"
	0E	0	Content: over-current
Cause		Confirmation	Solution
Short of driver output wire		Short of driver output wire, whether short circuit to PG ground or not	Assure driver output wire no short circuit, assure motor no damage
Abnormal wiring of motor		Check motor wiring order	Adjust motor wiring sequence
Short of IGBT module		Cut off driver output wiring, make srv_on available and drive motor, check whether over-current exists	replace the driver with a new one
abnormal setting of control parameter		Modify the parameter	Adjust parameter to proper range
abnormal setting of control command		Check control command whether command changes too violently or not	Adjust control command: open filter function

Error code	Main	Extra	Display: "EE0001"
	0E	1	Content: IPM over-current
Cause		Confirmation	Solution
Short of driver output wire		Short of driver output wire, whether short circuit to PG ground or not	Assure driver output wire no short circuit, assure motor no damage
Abnormal wiring of motor		Check motor wiring order	Adjust motor wiring sequence
Short of IGBT module		Cut off driver output wiring, make srv_on available and drive motor, check whether over-current exists or not	replace the driver with a new one
Short of IGBT module		/	replace the driver with a new one
abnormal setting of control parameter		Modify the parameter	Adjust parameter to proper range
abnormal setting of control command		Check control command whether command changes too violently or not	Adjust control command: open filter function

Error code	Main	Extra	Display: "EE0002"
	0E	2	Content: driver over-heat
Cause		Confirmation	Solution
the temperature of power module have exceeded upper limit		Check driver radiator whether the temperature is too high or not	Strengthen cooling conditions, promote the capacity of driver and motor, enlarge acceleration/deceleration time, reduce load

Error code	Main	Extra	Display: "EE0100"
	10	0	Content: motor over-load
Cause		Confirmation	Solution
Load is too		Check actual load if the value of	Decrease load, adjust limit parameter

heavy	parameter exceed maximum or not	
Oscillation of machine	Check the machine if oscillation exists or not	Modify the parameter of control loop; enlarge acceleration/deceleration time
wiring error of motor	Check wiring if error occurs or not, if line breaks or not	Adjust wiring or replace encoder/motor for a new one
electromagnetic brake engaged	Check brake terminal voltage	Cut off brake

Error code	Main	Extra	Display: "E28810-1"
	E10	-	Content: Motor overload/driver overload
Cause		Confirmation	Solution
Powerline connection error		UVW connection error	Check connection of UVW
Over current		Over current	Use another driver with higher rated power

Error code	Main	Extra	Display: "E288120"
	E12	0	Content: Resistance discharge circuit over-load
Cause		Confirmation	Solution
Regenerative energy has exceeded the capacity of regenerative resistor .		Check the speed if it is too high. Check the load if it is too large or not.	lower motor rotational speed; decrease load inertia ,increase external regenerative resistor, improve the capacity of the driver and motor
Resistance discharge circuit damage		/	Increase external regenerative resistor, replace the driver with a new one

Error code	Main	Extra	Display: "E28812-1"
	E12	1	Content: Leakage triode malfunction
Cause		Confirmation	Solution
Brake circuit failure		Brake resistance short circuit	repair
		IGBT damaged	repair

Error code	Main	Extra	Display: "E288150"
	E15	0	Content: encoder line breaked
Cause		Confirmation	Solution
Encoder line disconnected		check wiring if it steady or not	Make encoder wiring steady
Encoder wiring error		Check encoder wiring if it is correct or not	Reconnect encoder wiring
Encoder damaged		/	replace the motor with a new one
Encoder measuring circuit damaged		/	replace the driver with a new one

Error	Main	Extra	Display: "E28815-1"
--------------	------	-------	----------------------------

code	15	1	Content: Encoder communication error
Cause			Confirmation
Encoder communication error			Interference is caused by noise
			Solution

Error code	Main	Extra	Display: "E20015"
	15	2	Content: initialized position of encoder error
Cause			Confirmation
Communication data abnormal			Check encoder power voltage if it is DC5V \pm 5% or not; check encoder cable and shielded line if it is damaged or not; check encoder cable whether it is intertwined with other power wire or not
Encoder damaged			/
Encoder measuring circuit damaged			/
			Solution
			Ensure power voltage of encoder normally, ensure encoder cable and shielded line well with FG ground, ensure encoder cable separated with other power wire
			replace the motor with a new one
			replace the driver with a new one

Error code	Main	Extra	Display: "E20017"
	17	0	Content: encoder data error
Cause			Confirmation
Communication data abnormal			Check encoder power voltage if it is DC5V \pm 5% or not ; check encoder cable and shielded line if it is damaged or not; check encoder cable whether it is intertwined with other power wire or not
Encoder damaged			/
Encoder measuring circuit damaged			/
			Solution
			Ensure power voltage of encoder normally, ensure encoder cable and shielded line well with FG ground, ensure encoder cable separated with other power wire
			replace the motor with a new one
			replace the driver with a new one

Error code	Main	Extra	Display: "E20018"
	18	0	Content: position error over-large error
Cause			Confirmation
Unreasonable set of position error parameter			Check parameter PA_014 value if it is too small or not
Gain set is too small			Check parameter PA_100, PA_105 value if it is too small or not
Torque limit is too small			Check parameter PA_013, PA_522 value whether too small or not
Outside load is too large			Check acceleration/ deceleration time if it is too small or not , check motor rotational speed if it is too big or not ; check load if it is too large or not
			Solution
			Enlarge the value of PA_014
			Enlarge the value of PA_100, PA_105
			Enlarge the value of PA_103, PA_522
			Increase acceleration/ deceleration time decrease speed, decrease load

Error code	Main	Extra	Display: "E20018"
	18	1	Content: velocity error over-large error

Cause	Confirmation	Solution
The deviation of inner position command velocity is too large with actual speed	Check the value of PA_602 if it is too small or not	Enlarge the value of PA_602, or set the value to 0, make position deviation over-large detection invalid
The acceleration/ decelerate time Inner position command velocity is too small	Check the value of PA_312, PA_313 if it is too small or not	Enlarge the value of PA_312, PA_313. adjust gain of velocity control, improve trace performance.

Error code	Main	Extra	Display: "E28890"
	E19	0	Content: excessive vibration
Cause		Confirmation	Solution
Current vibration		Current vibration	Cut down the value of Pr003. Pr004
Stiffness is too strong		Stiffness is too strong	

Error code	Main	Extra	Display: "E2881A0"
	E1A	0	Content: over-speed 1
Cause		Confirmation	Solution
Motor speed has exceeded the first speed limit (PA_321)		Check speed command if it is too large or not; check the voltage of analog speed command if it is too large or not; check the value of PA_321 if it is too small or not; check input frequency and division frequency coefficient of command pulse if it is proper or not; check encoder if the wiring is correct or not	Adjust the value of input speed command, enlarge the value PA_321 value, modify command pulse input frequency and division frequency coefficient, assure encoder wiring correctly

Error code	Main	Extra	Display: "E2881A1"
	E1A	1	Content: Motor speed out of control
Cause		Confirmation	Solution
UVW connection error		UVW connection error	
Encoder error		Encoder error	Replace motor
Special function			Set Pr1.37=4

Error code	Main	Extra	Display: "E2881B0"
	E1B	0	Content: Wrong pulse input frequency
Cause		Confirmation	Solution
Wrong pulse input frequency			

Error code	Main	Extra	Display: "E2881B1"
	E1B	1	Content: Electronic gear ratio error
Cause		Confirmation	Solution
Pulse input frequency is too		Pulse input frequency is too high	Make sure the pulse frequency is blew 500K

high		
------	--	--

Error code	Main	Extra	Display: "E2E2E0"
	21	0	Content: I/F input interface allocation error
Cause		Confirmation	Solution
The input signal are assigned with two or more functions.		Check the value of PA_400, PA_401, PA_402,PA_403,PA_404 if it is proper or not	Assure the value of PA_400, PA_401, PA_402, PA_403, PA_404 set correctly
The input signal aren't assigned with any functions.		Check the value of PA_400, PA_401,PA_402,PA_403,PA_404 if it is proper or not	Assure parameter PA_400, PA_401, PA_402,PA_403,PA_404 set correctly

Error code	Main	Extra	Display: "E2E2E1"
	21	1	Content: I/F input interface function set error
Cause		Confirmation	Solution
Signal allocation error		Check the value of PA_400, PA_401, PA_402,PA_403,PA_404 if it is proper or not	Assure the value of PA_400, PA_401, PA_402, PA_403, PA_404 set correctly

Error code	Main	Extra	Display: "E2E2E2"
	21	2	Content: I/F input interface function set error
Cause		Confirmation	Solution
The input signal are assigned with two or more functions.		Check the value of PA_410, PA_411, PA_412, PA_413, if it is proper or not	Assure the value of PA_410, PA_411, PA_412,PA_413 set correctly
The input signal aren't assigned with any functions.		Check the value of PA_410, PA_411, PA_412, PA_413, if it is proper or not	Assure the value of PA_410, PA_411,PA_412,PA_413 set correctly

Error code	Main	Extra	Display: "E2E2E4"
	24	0	Content: CRC verification error when EEPROM parameter is saved
Cause		Confirmation	Solution
Vdc/GND under-voltage		Check the voltage of Vdc/GND terminal	Make sure voltage of Vdc/GND in proper range
Driver is damaged		save the parameters for several times	replace the driver with a new one
The setting of driver maybe default setting which isn't suitable for motor .		Check the setting of driver if it is suitable for your motor	Download the suitable project file to driver for motor

Error code	Main	Extra	Display: “ 888260 ”
	26	0	Content: positive negative over-travel input valid
Cause		Confirmation	Solution
positive /negative over-travelling input signal has been conducted		Check the state of positive negative over-travel input signal	/

Error code	Main	Extra	Display: “ 888270 ”
	27	0	Content: Analog value 1 input error limit
Cause		Confirmation	Solution
Analog value 1 input error limit		Analog value 1 input error limit	

Error code	Main	Extra	Display: “ 888570 ”
	57	0	Content: forced alarm input valid
Cause		Confirmation	Solution
Forced-alarm input signal has been conducted		Check forced-alarm input signal	Assure input signal wiring correctly

Error code	Main	Extra	Display: “ 8885E0 ”
	5E	0	Content: Motor code error
Cause		Confirmation	Solution
Motor code error		Motor code error	Set Pr7.15 correctly

Appendix

A. Modbus Communication

There are two kinds of Modbus communication methods of drives: RS485 and RS232. RS232 belongs to point-to-point communication, which is used for PC protocol and cannot realize multi-network. RS485 belongs to a single master and multi slave communication mode and can realize multi network control.

A.1 Wiring

- (1) The shorter the connection between each node is the better. The recommend connection should no more than 3m;
- (2) Connect one terminal resistor to each end of the node. The recommended resistance value is 120 ohms;
- (3) Shielded twisted pair is recommended for RS485 communication wirings;
- (4) Connect GND is essential for communication;
- (5) When using the shield wire, the two ends of the shield should connect PE, not GND, otherwise the port will be damaged;
- (6) In order to reduce interference, RS485 communication cables should installed separately from other cables;

A.2 Parameters and interface for communication

A.2.1 Parameters setting

Pr5. 29 *	Name	Mode setup of RS485 communication			Mode	P	S	T																												
	Range	0~255	Unit	—	Default	5																														
	Data Type	16bit	Access	R/W	Address	053BH																														
	Repower	-																																		
<table border="1"> <thead> <tr> <th>Setup Value</th> <th>Data bit</th> <th>Parity-check</th> <th>Stop bit</th> </tr> </thead> <tbody> <tr> <td>0</td> <td>8</td> <td>Even Parity</td> <td>2</td> </tr> <tr> <td>1</td> <td>8</td> <td>Odd Parity</td> <td>2</td> </tr> <tr> <td>2</td> <td>8</td> <td>Even Parity</td> <td>1</td> </tr> <tr> <td>3</td> <td>8</td> <td>Odd Parity</td> <td>1</td> </tr> <tr> <td>4</td> <td>8</td> <td>None</td> <td>1</td> </tr> <tr> <td>5</td> <td>8</td> <td>None</td> <td>2</td> </tr> </tbody> </table>									Setup Value	Data bit	Parity-check	Stop bit	0	8	Even Parity	2	1	8	Odd Parity	2	2	8	Even Parity	1	3	8	Odd Parity	1	4	8	None	1	5	8	None	2
Setup Value	Data bit	Parity-check	Stop bit																																	
0	8	Even Parity	2																																	
1	8	Odd Parity	2																																	
2	8	Even Parity	1																																	
3	8	Odd Parity	1																																	
4	8	None	1																																	
5	8	None	2																																	
Pr5. 30 *	Name	Baud rate setup of RS485 communication			Mode	P	S	T																												
	Range	0~6	Unit	—	Default	2																														

	Data Type	16bit	Access	R/W	Address	053DH																				
	Repower	-																								
Set up the communication baud rate of RS485.																										
<table border="1"> <thead> <tr> <th>Setup value</th> <th>Baud rate</th> <th>Setup value</th> <th>Baud rate</th> </tr> </thead> <tbody> <tr> <td>0</td> <td>2400bps</td> <td>4</td> <td>38400bps</td> </tr> <tr> <td>1</td> <td>4800bps</td> <td>5</td> <td>57600bps</td> </tr> <tr> <td>2</td> <td>9600bps</td> <td>6</td> <td>115200bps</td> </tr> <tr> <td>3</td> <td>19200bps</td> <td></td> <td></td> </tr> </tbody> </table>							Setup value	Baud rate	Setup value	Baud rate	0	2400bps	4	38400bps	1	4800bps	5	57600bps	2	9600bps	6	115200bps	3	19200bps		
Setup value	Baud rate	Setup value	Baud rate																							
0	2400bps	4	38400bps																							
1	4800bps	5	57600bps																							
2	9600bps	6	115200bps																							
3	19200bps																									

Pr5. 31 *	Name	RS485 slave axis address		Mode	P	S	T
	Range	0~127	Unit	-	Default	1	
	Data Type	16bit	Access	R/W	Address	053FH	
	Repower	-					
During communication with the host (e.g. PC) to control multiple shafts, the shaft being accessed by the host should be identified. Note: when using RS232/RS485, the maximum valid value is 31.							

A.2.2 RS232/RS485 Communication Port

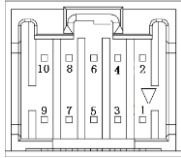
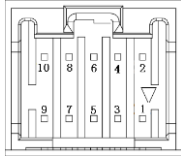
CN6		Pin	Signal	Detail
485 IN		1	RS485+	485data+
		3	RS485-	485 data-
		5	485GND	485 GND
		other	NC	
CN6		Pin	Signal	Detail
485 OUT		1	RS485+	485data+
		3	RS485-	485 data-
		5	485GND	485 GND
		other	NC	

A.3 Modbus Protocol

The drive supports 16bit data read and write of Modbus-RTU protocol, and its function codes include 0x03, 0x06 and 0x10. 0x03 read data function code, 0x06 write single data function code and 0x10 write multiple data function code.

Notes: 1 word=2byte=16bit

A.3.1 Function code of read data 0x03

The function code of read data is 0x03. It can read 1~100 16bit data. Now take slave ID 1, read 2 data as

an example: (H is 8bit high for 16bit, L is 8bit low for 16bit)

NO	Send frame			Receive frame		
1	ID	Slave ID	0x01	ID	Slave ID	0x01
2	FC	Function code	0x03	FC	Function code	0x03
3	ADDR	Address	H	NUM	Data quantity (Byte)	0x00(H)
4			L			0x04(L)
5	NUM	Data quantity (Word)	0x00(H)	DATA1	Data1	H
6			0x02(L)			L
7	CRC	Check code	L	DATA2	Data2	H
8			H			L
9				CRC	Check code	L
10						H

Notes: The number of receive data is twice the number of send data quantity.

The communication data is shown as below:

[Send frame] 01 03 00 04 00 02 85 CA

[Receive frame] 01 03 04 00 00 00 02 7B F2

Send frame: The sent frame represents that the master reads the data from slave ID 1, the starting address is 0x0004, the length is 2 Word (16bit). The CRC check code is 0xCA85.

Receive frame: The receive frame represents that the receive data is 4 byte (8bit) and the data is 00 00 00 02. The CRC check code is 0xF27B.

A.3.2 Function code of write single data 0x06

The function code of write single data is 0x06. Now take slave ID 1, write 1 data as an example: (H is 8bit high for 16bit, L is 8bit low for 16bit)

NO	Send frame			Receive frame		
1	ID	Slave ID	0x01	ID	Slave ID	
2	FC	Function code	0x06	FC	Function code	
3	ADDR	Address	H	ADDR	Address	H
4			L			L
5	DATA	Data quantity (Word)	H	DATA	Actually written data quantity	H
6			L			L
7	CRC	Check code	L	CRC	Check code	L
8			H			H

Notes: The number of receive frame is the same as the send frame.

The communication data is shown as below:

[Send frame] 01 06 00 04 00 02 49 CA

[Receive frame] 01 06 00 04 00 02 49 CA

Send frame: The send frame represents that the master write the data into slave ID 1, the starting address is 0x0004, the length is 2 Word (16bit). The data is 0x0002. The CRC check code is 0xCA49.

Receive frame: The receive frame represents that write data into slave ID 1 finished successfully.

A.3.3 Function code of write multiple data 0x10

The function code of write multiple data is 0x10. In this case, 16 bits of multiple data are written. Now take slave ID 1, write 2 data as an example: (H is 8bit high for 16bit, L is 8bit low for 16bit)

NO	Send frame			Receive frame		
1	ID	Slave ID	0x01	ID	Slave ID	0x01
2	FC	Function code	0x10	FC	Function code	0x10
3	ADDR	Address	H	ADDR	Address	H
4			L			L
5	NUM1	Data quantity (Word)	0x00 (H)	NUM	Actually written data quantity	0x00 (H)
6			0x02 (L)			0x02 (L)
7	NUM2	Data quantity (Byte)		CRC	Check code	L
						H
8	DATA1	DATA1	H			
9			L			
	DATA2	DATA2	H			
			L			
	CRC	Check code	L			
			H			

The communication data is shown as below:

[Send frame] 01 10 00 04 00 02 04 01 00 00 00 F3 A0

[Receive frame] 01 10 00 04 00 02 00 09

Send frame: The send frame represents that the master write the data into slave ID 1, the starting address is 0x0004, the length is 2 Word (16bit). The data is 0x01000 and 0x0000. The CRC check code is 0xA0F3.

Receive frame: The receive frame represents that write data into slave ID 1 finished successfully.

A.3.4 Error response

When there is a mistake in the format of the send frame data, the slave feeds back the wrong reply frame data to the master station. The format is as follows:

NO	Error response frame data (Slave-->Master)		
1	ID	Slave ID	0~31
2	FC	Function code	(0x03/0x06/0x10)+0x80
3	Error code	Error code	0x01/0x02/0x03/0x08
4	CRC	Check code	L
5			H

The error code and its meaning are as follows:

Error code	Meaning
0x01	Function code error
0x02	Access address error
0x03	Data error, such as write data exceeding the limit
0x08	CRC check error

The communication data is shown as below:

[Send frame] 01 11 00 04 00 02 04 01 00 00 00 F3 A0

[Receive frame] 01 91 08 4C 56

Receive: CRC check error in the send data frame sent by the master station

[Send frame] 01 11 00 04 00 02 04 01 00 00 00 A2 65

[Receive frame] 01 91 01 8C 50

Receive: Function code error in the send data frame sent by the master station

A.4 RS485 common problems and solutions

A.4.1 Common problems

1、 Terminal resistance

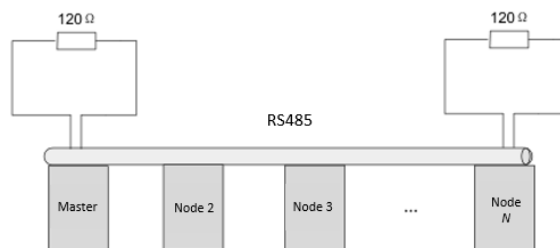

The correct connection of terminal resistance is shown in the above figure, a 120 ohm terminal resistance need to connect in the head end and the end of the communication bus.

2、 Wiring error

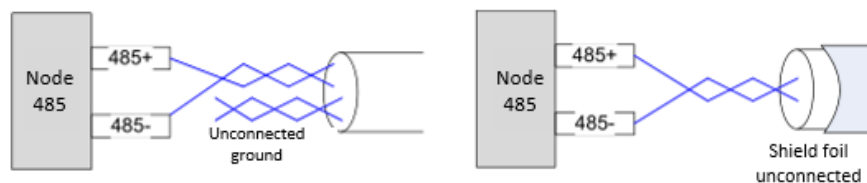

Firstly, confirm that the signal line of RS485 is connected correctly. Secondly, confirm whether the communication reference ground is connected correctly. If the node has no communication reference ground, it will be suspended, as shown in figure above. The shielding is connected the same way.

3、 Signal interference

When there is an external interference signal in communication, magnetic rings can be placed at 1 and 2 in above figure to suppress the incoming external interference signal into the bus.

When there is an internal interference signal in communication, magnetic rings can be placed at 1 and 2 in above figure to suppress the incoming internal interference signal into the bus. Loop the UVW line around the magnetic ring three times. Be careful not to connect PE to the magnetic ring.

A.4.2 Problem solving procedure

1. Whether the communication parameters are set correctly (Slave ID no repetition, baud rate is set the same, data format is consistent).
2. Whether the terminal resistance connection is correct?
3. Whether the wiring is standard for anti-interference?
4. PE connection between ground and ground wire.
5. Whether the communication lines are installed separately from other wirings

Contact us

China Headquarters

Address: 15-20/F, Block B, Nanshan I Valley, No.3157, Shahe West Road, Nanshan District, Shenzhen

Leadshine America, Inc.

North America Office

Address: 26050 Towne Centre Dr. Foothill Ranch California United States

Tel: 1-949-608-7270

Fax: 1-949-638-7298

Website: www.leadshineusa.com

Emails: sales@leadshineusa.com

Technical Support

Email: tech@leadshine.com

Sales

Email: sales@leadshine.com