

ELP AC SERVO DRIVE

USER MANUAL



©2019 Leadshine Technology Co., Ltd.

Address: 15-20/F, Block B, Nanshan I Valley, No.3185, Shahe West Road, Nanshan District, Shenzhen, Guangdong, 518055, China

Tel: (86)755-26409254

Fax: (86)755-26402718

Web: www.leadshine.com

Sales: sales@leadshine.com

Support: tech@leadshine.com

Notice

Read this manual carefully before any assembling and using. Incorrect handling of products in this manual can result in injury and damage to persons and machinery. Strictly adhere to the technical information regarding installation requirements.

This manual is not for use or disclosure outside of Leadshine except under permission. All rights are reserved. No part of this manual shall be reproduced, stored in retrieval form, or transmitted by any means, electronic, mechanical, photocopying, recording, or otherwise without approval from Leadshine. While every precaution has been taken in the preparation of the book, Leadshine assumes no responsibility for errors or omissions. Neither is any liability assumed for damages resulting from the use of the information contained herein.

This document is proprietary information of Leadshine that is furnished for customer use ONLY. Information in this document is subject to change without notice and does not represent a commitment on the part of Leadshine. Therefore, information contained in this manual may be updated from time-to-time due to product improvements, etc., and may not conform in every respect to former issues.

Record of Revisions

Manual Reversion	Date	Description of Release
V1.0	04/13/2022	Initial Release

Contents

ELP Series Function Guidance.....	7
Chapter 1 Safety Tips	8
1.1 Safety Items.....	8
1.2 Safety Precautions	8
1.3 Acceptance	9
1.4 Transportation.....	9
1.5 Installation.....	9
1.6 Wiring.....	9
1.7 Debugging and Running.....	10
1.8 Using	10
1.9 Fault Processing	10
Chapter 2 Product Introduction	11
2.1 Drive Introduction	11
2.1.1 Ordering Options.....	11
2.1.2 Interface.....	11
2.1.3 Drive Specifications	12
2.1.4 Drive Dimension	14
2.2 Motor Description	15
2.2.1 Model Designation	15
2.2.2 Motor Specification.....	15
2.2.2.1 Servo Motor with 17-bit Magnetic Single-turn Encoder for Frame 40/60/80.....	15
2.2.2.2 Servo Motor with 23-bit Optical Multi-turn Encoder for Frame 40/60/80.....	17
2.2.2.3 Servo Motor with 23-bit Optical Multi-turn Encoder for Frame 130.....	18
2.2.2.4 Servo Motor with 23-bit Optical Multi-turn Encoder for Frame 180.....	20
2.2.3 N-T Characteristics.....	21
2.3 Cable Description.....	22
2.3.1 Matching Cable	22
2.3.2 Cable Detail.....	23
2.3.2.1 Cable with SS Plug for Frame 40/60/80.....	23
2.3.2.2 Cable with HH2 Plug for Frame 40/60/80.....	24
2.3.2.3 Cable with DC Plug for Frame 40/60/80.....	25
2.3.2.4 Cable with H Plug for Frame 130.....	26
2.3.2.5 Cable with HD Plug for Frame 130.....	27
2.3.2.6 Cable with H Plug for Frame 180.....	28
Chapter 3 Installation	30
3.1 Storage and Installation Condition	30
3.2 Servo Drive Installation.....	30
3.3 Servo Motor Installation.....	31
Chapter 4 Wiring	33
4.1 Wiring.....	33
4.1.1 Wire Gauge.....	33

4.1.2 Position Control Mode	35
4.1.3 Torque /Velocity Control Mode	36
4.2 Drive Port Function	37
4.2.1 Control Signal Port-CN1	37
4.2.2 Encoder Input Port-CN2.....	38
4.2.3 RS232/ RS485 Communication Port-CN4/ CN5	38
4.2.4 USB Communication Port-CN3	39
4.2.5 Power Port-X1	39
4.3 I/O Interface Principles	40
4.3.1 Switch Input Interface	40
4.3.2 Switch Output Interface.....	42
4.3.3 Pulse Input Interface.....	44
4.3.4 Analog Value Input Interface.....	46
4.4 Battery Installation	47
4.5 Anti-Interference Solution.....	49
Chapter 5 Parameter	50
5.1 Parameter List	50
5.2 Parameter Function	58
5.2.1 【Class 0】 Basic Setting	58
5.2.2 【Class 1】 Gain Adjust	68
5.2.3 【Class 2】 Vibration Suppression.....	73
5.2.4 【Class 3】 Velocity/ Torque Control.....	77
5.2.5 【Class 4】 I/F Monitor Setting	84
5.2.6 【Class 5】 Extended Setup	92
5.2.7 【Class 6】 Special Setup	98
5.2.8 【Class B】 Status Information	103
Chapter 6 Alarm and Processing	108
6.1 Alarm List.....	108
6.2 Alarm Processing Method	111
6.3 Alarm Clear	118
Chapter 7 Display and Operation	119
7.1 Introduction	119
7.2 Panel Display and Operation.....	119
7.2.1 Panel Operation Flow Figure.....	119
7.2.2 Drive Operating Data Monitor	120
7.2.3 Auxiliary Function.....	123
7.2.4 Saving Parameter.....	124
7.2.5 Abnormal Alarm	125
7.3 Trial Run.....	125
7.3.1 Inspection before Trial Run	125
7.3.2 Timing Chart on Power-Up	126
7.3.3 Timing Chart on Fault	126
7.3.4 Holding Brake	126
7.3.5 Trial Run Jog Control	127

Chapter 8 Application Case.....	129
8.1 Position Control.....	129
8.1.1 Pulse Command and Rotation Direction	132
8.1.2 Electronic Gear Function.....	133
8.1.3 Position Command Filter.....	134
8.1.4 Motor Encoder Pulse Output	134
8.1.5 Position Complete Output (INP)	135
8.2 Velocity Control	136
8.2.1 Velocity Control by Analog Command	138
8.2.2 Velocity Mode Control by Internal Speed Command.....	141
8.2.3 Speed Command Acceleration and Deceleration	144
8.2.4 Attained Speed Signal AT-SPEED Output.....	146
8.2.5 Speed Coincidence Output (V-COIN).....	146
8.2.6 Zero-Speed Clamp (ZEROSPD)	147
8.3 Torque Control	148
8.3.1 Torque Mode Control by Analog Command Input.....	149
8.3.2 Torque Limit Function.....	151
8.4 Inertia Ratio Identification	152
8.4.1 On-Line Inertia Ratio Identification	152
8.4.2 Off-Line Inertia Ratio Identification	152
8.4.3 Motion Studio Inertia Ratio Identification	153
8.5 Vibration Suppression	153
8.6 Third Gain Switching	155
8.7 Friction Torque Compensation	156
8.8 Regenerative Resister Setting.....	157
8.9 Security Features	157
8.9.1 Speed Limit	157
8.9.2 Torque Limit (TL-SEL).....	157
8.10 Multi-Turn Absolute Encoder.....	158
8.10.1 Parameters Setting.....	158
8.10.2 Read Absolute Position	159
8.10.3 Alarm.....	160
8.11 Other Functions	161
8.11.1 Zero Speed Output (ZSP)	161
8.11.2 Position Deviation Cleared (CL)	161
8.11.3 Position Setup Unit Select.....	162
Chapter 9 PR-Mode.....	163
9.4 Overview of PR-Mode	163
9.4.1 Main Function	163
9.4.2 Programmable Digital Inputs and Outputs in PR-Mode.....	164
9.5 PR-Mode Parameters.....	165
9.5.1 8th Parameters Specification	165
9.5.2 9th Parameters Specification	167
9.6 PR-Mode Motion Control	168

9.6.1 Homing	168
9.6.2 Position Limit and E-Stop	170
9.6.3 JOG.....	170
9.6.4 Path Motion	171
9.7 Execute movement of PR-Mode	174
9.7.1 Execute Movement by Configuration Software	174
9.7.2 Execute Movement by Digital Signal.....	176
9.7.3 Execute Movement by RS485 Communication	178
9.7.4 Fixed Trigger Method.....	180
9.7.5 Immediately Trigger Method.....	182
9.8 Operation Examples	183
9.8.1 Execute Movement by Digital Signal.....	183
9.8.2 Execute Movement by RS485 Communication	185
Chapter 10 Order Guidance.....	192
10.1 Capacity Selection.....	192
10.2 Electronic Gear Ratio	192
Appendix Modbus Communication	193
A.1 Wiring (CN4&CN5).....	193
A.2 Communication Parameters Setting	194
A.3 Modbus Transmission Protocol	195
A.3.1 Message Types.....	195
A.3.2 Function Codes (FC)	196
A.3.3 Error Response	197
A.4 Communication Problems and Solutions	198
A.4.1 Troubleshoot Steps	198
A.4.2 Frequently Asked Questions.....	198
Contact Us.....	201

ELP Series Function Guidance

No.	Function	Details	Section Index
1	Position Control	Position control parameter specification, guidance	8.1 Position Control
2	Velocity Control	Velocity control parameter specification, guidance	8.2 Velocity Control
3	Torque Control	Torque control parameter specification, guidance	8.3 Torque Control
4	Encoder Type	17bit/23bit encoder	
5	Auxiliary Function	JOG, parameter initialization, Soft Reset, inertia ratio identification etc.	7.2.3 Auxiliary Function
6	Vibration Suppression	It can suppress torque oscillation caused by too high rigidity	8.5 Vibration Suppression
7	Inertia Ratio Identification	The inertia of the load can be accurately identified by a simple trial run	8.4 Inertia Ratio Identification
8	Electronic Gear Function	A certain range of electronic gear ratio can be set	8.1.2 Electronic Gear Function
9	Position Command Filter	FIR filter and command smoothing filter are used to smooth the position command	8.1.3 Position Command Filter
10	Acceleration And Deceleration	Set the speed command acceleration and deceleration	8.2.3 Speed Command Acceleration And Deceleration
11	Third Gain Switching	An additional third gain is added to allow faster positioning by switching between the first and second gain	8.6 Third Gain Switching
12	Friction Torque Compensation	The friction torque and gravity torque are compensated for the load.	8.7 Friction Torque Compensation
13	Alarm Processing Method	Method for dealing with alarm.	6.2 Alarm Processing Method
14	IO Interface Principle	IO input and output functions and each function can be freely configured to any physical IO port, Six IO outputs are available for master station operation through parameter setting	4.3 IO Interface Principle
15	Trial Run	Directly through the servo drive panel or PC can achieve servo motor operation	7.3 Trial Run
16	Torque Limit	Available to limit torque.	8.9.2 Torque Limit
17	Speed Limit	Available to limit speed.	8.9.1 Speed Limit
18	Regenerative Resister Setting	Support internal brake resistance and external brake resistance, match the resistance through parameter setting	8.8 Regenerative Resister Setting
19	Drive Operating Data Monitor	Drive operating data monitor	7.2.2 Drive Operating Data Monitor
20	Alarm And Processing	A variety of alarm code output to protect the servo drive security	Chapter 6 Alarm And Processing
21	Multi-Turn Absolute Encoder	The drive use the memory position of the motor with multi-turn absolute encoder to realize the function of not losing absolute position after restart power supply	8.10 Multi-Turn Absolute Encoder

Chapter 1 Safety Tips

Thanks for purchasing Leadshine ELP series AC servo drive, this instruction manual provides knowledge and attention for using this drive.

Contact tech@leadshine.com if you need more technical service.

Incorrect operation may cause unexpected accident, please read this manual carefully before using product.

- Leadshine reserve the right to modify equipment and documentation without prior notice.
- Leadshine won't undertake any responsibility to customer's any modification of product, and the warranty of product will be cancel at the same time.







1.1 Safety Items

ELP series servo drive should be mounted in cover type control box during operating.

The mounting of drive, wiring and motor should be under the regulations of EN 61800-5-1.

Safety items indicate a potential for personal injury or equipment damage if the recommended precautions and safe operating practices are not followed.

The following safety-alert symbols are used on the drive and in the documentation:

	Indicates great possibility of death or serious injury
	Indicates something that must be done.
	Indicates something that must not be done.
	Indicates dangerous voltage.
	Indicates do not touches hot heat sink when power on.
	Protective earth

1.2 Safety Precautions

Warning

- The design and manufacture of product doesn't use in mechanic and system which have a threat to operator.
- The safety protection must be provided in design and manufacture when using the product to prevent incorrect operation or abnormal accident.

1.3 Acceptance



Caution

- The product that is damaged or have fault is forbidden to use.

1.4 Transportation



Caution

- The storage and transportation must be in normal condition.
- Don't stack too high, prevent falling.
- The product should be packaged properly in transportation.
- Don't hold the product by the cable, motor shaft or encoder while transporting it.
- The product can't undertake external force and shock.

1.5 Installation



Caution

Servo Drive and Servo Motor:

- Don't install them on inflammable substance or near it to preventing fire hazard.
- Avoid vibration, prohibit direct impact.
- Don't install the product while the product is damaged or incomplete.

Servo Drive:

- Must install in control cabinet with sufficient safeguarding grade.
- Must reserve sufficient gap with the other equipment.
- Must keep good cooling condition.
- Avoid dust, corrosive gas, conducting object, fluid and inflammable, explosive object from invading.

Servo Motor:

- Installation must be steady, prevent drop from vibrating.
- Prevent fluid from invading to damage motor and encoder.
- Prohibit knocking the motor and shaft, avoid damaging encoder.
- The motor shaft can't bear the load beyond the limits.

1.6 Wiring



Warning

- The workers of participation in wiring or checking must possess sufficient ability do this job.
- The wiring and check must be going with power off after 10 minutes.

**Caution**

- The wiring must be connected correctly and steadily, otherwise servo motor may run incorrectly, or damage the equipment.
- Servo motor U, V, W terminal should be connected correctly, it is forbidden to connect them directly to AC power.
- Leadshine mustn't connect capacitors, inductors or filters between servo motor and servo drive.
- The wire and temperature-resistant object must not be close to radiator of servo drive and motor.
- The freewheel diode which connect in parallel to output signal DC relay mustn't connect reversely.

1.7 Debugging and Running

**Caution**

- Make sure the servo drive and servo motor installed properly before power on, fixed steadily, power voltage and wiring correctly.
- The first time of debugging should be run without loaded, debugging with load can be done after confirming parameter setting correctly, to prevent mechanical damage because of error operation.

1.8 Using

**Caution**

- Install a emergency stop protection circuit externally, the protection can stop running immediately to prevent accident happened and the power can be cut off immediately.
- The run signal must be cut off before resetting alarm signal, just to prevent restarting suddenly.
- The servo drive must be matched with specified motor.
- Don't power on and off servo system frequently, just to prevent equipment damaged.
- Forbidden to modify servo system.

1.9 Fault Processing

**Warning**

- The high voltage also will contain in several minutes even if the servo drive is powered off, please don't touch terminal strip or separate the wiring.
- The workers of participation in wiring or checking must possess sufficient ability do this job.

**Caution**

- The reason of fault must be figured out after alarm occurs, reset alarm signal before restart.
- Keep away from machine, because of restart suddenly if the drive is powered on again after momentary interruption (the design of the machine should be ensured to avoid danger when restart occurs).

Chapter 2 Product Introduction

2.1 Drive Introduction

2.1.1 Ordering Options

ELP-D 2000 Z

① ② ③ ④

No.	Details			
①	Drive series	ELP: ELP AC servo drive		
②	Command Source	D: Standard version (Pulse+Direction) RS: RS485 (Modbus/ Pulse+Direction/ Analog) EC: EtherCAT		
②	Rated Power	0400: 400W 1500: 1500W	0750: 750W 2000: 2000W	1000:1000W
④	Version	Z: Standard Version	S: Enhanced Version	

2.1.2 Interface

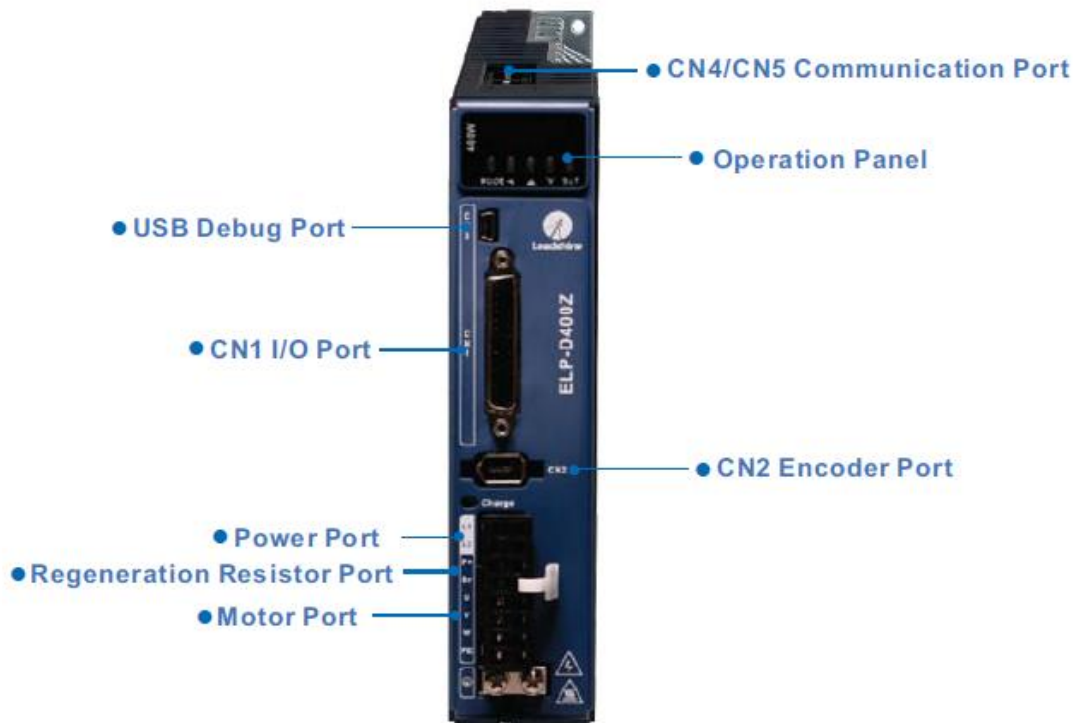

2.1.3 Drive Specifications

Table 2.1 Specifications A

Drive Model	ELP-*0400Z	ELP-*0750Z	ELP-*1000Z	ELP-*1500Z	ELP-*2000Z
Rated Output Power (W)	400	750	1000	1500	2000
Rated Output Current (Arms)	3	5.5	7	9.5	12
Peak Output Current (Arms)	9	16	21	28.5	36
Main Power Control Power	Single phase 220V -15%~+10% 50/60Hz			Single phase /Three phase 220V -15%~+10% 50/60Hz	
Control Method	IGBT SVPWM sinusoidal wave control				
Feedback Mode	RS485 protocol				
Input Pulse	0-500kHz,5V differential input ; 0-200kHz,24V single-ended input				
Speed Frequency Response (Hz)	3100				
Electronic Gear Ratio	1~32767/1~32767				
Analog Input	-10~10VDC, input resistance 20kΩ, no isolation (Only available for ELP-RS model)				
Input Signal	DI: 9 inputs (Support two wiring methods of common+ or common-) (1) Servo enable (SRV-ON) (2) Alarm clear (A-CLR) (3) Gain switch (Gain) (4) Deviation counter clear (CL) (5) Command pulse inhibition (INH) (6) Selection 1 of internal command speed (INTSPD1) (7) Selection 2 of internal command speed (INTSPD2) (8) Selection 3 of internal command speed (INTSPD3) (9) Switch 1 of command frequency division and multiplication (DIV1) (10) Switch 2 of command frequency division and multiplication (DIV2) (11) Positive drive inhibition (POT) (12) Negative drive inhibition (NOT) (13) Symbol of command velocity (VC-SIGN) (14) Symbol of command torque (TC-SIGN) (15) Zero-speed clamp (ZEROSPD) (16) Forced alarm (E-STOP)				
Output Signal	DO: 6 outputs (4 single-ended output, 2 differential output) (1) Servo ready (S-RDY) (2) External brake-off (BRK-OFF) (3) Positioning completed (INP) (4) At-speed (AT-SPEED) (5) Zero-speed clamp detection (ZSP) (6) Alarm (ALM) (7) Command velocity signal (V-CMD) (8) Command position signal (P-CMD) (9) Velocity coincidence (V-COIN)				
Encoder Signal Output	(1) phase A, phase B, phase Z (2)Long-wire drive mode output				
Alarm Function	Over-voltage, under-voltage, over-current, over-load, over-heat, over-speed, encoder error, input phase-lacking, abnormal braking status, excess position deviation, excess braking ratio, over-travel, EEPROM error etc.				
Operation and Display	jog, trapezoidal wave test, each parameter and input output signal can be modified and saved, six-bit LED to display rotational speed, current, position deviation, drive type version and address ID value etc.				
GUI Software	(1) Able to adjust the parameters of current loop, velocity loop and position loop. (2) Able to adjust the input values, output signals and the parameter of motor, these values are available to be saved to files and also could be downloaded and uploaded.				

	(3) Able to monitor the waveform of velocity and position while testing.	
Communication Interface	(1) USB: Based on Modbus protocol. (According to USB2.0 specification) (2) RS485: Based on Modbus protocol.	
Brake Mode	Built-in brake resistor 50Ω/50W (Available for external brake resistor)	
Adapt Load Inertia	Less than 10 times motor inertia	
Weight	About 1.5-3Kg	
Environment	Environment	Avoid dust, oil fog and corrosive gases
	Ambient Temp	0 to +40°C.
	Humidity	40% RH to 90%RH, no condensation
	Vibration	5.9 m/s ² MAX
	Storage Temperature	-20~80°C
	Installation	Vertical installation

Table 2.1 Specifications B

Drive Model	ELP-D***Z	ELP-RS***Z	ELP-EC***Z
Control Mode	<ul style="list-style-type: none"> ● Position control ● JOG 	<ul style="list-style-type: none"> ● Position control ● Velocity control ● Torque control ● JOG 	<ul style="list-style-type: none"> ● CSP(Cyclic Synchronous Position) ● CSV(Cyclic Synchronous Velocity) ● CST(Cyclic Synchronous Torque) ● PP(Profile Position) ● PV(Profile Velocity) ● PT(Profile Torque) ● HM(Homing)
Encoder Output	5V differential,0~500kHz 24V single-ended,0~200kHz	5V differential,0~500kHz 24V single-ended,0~200kHz	--
Digital Input	9 inputs (common-cathode common-anode)	9 inputs (common-cathode common-anode)	14 inputs (common-cathode/common-anode) 2 differential (for capture probe)
Digital Output	6 outputs(4 single-ended, 2 differential)		
Analog Input	--	2 analog input:-10~+10Vdc	--
Network	--	Modbus RTU(RJ45)	EtherCAT(RJ45)
Maximum Frequency Of Pulse Input	5V differential,0~500kHz 24V single-ended,0~200kHz z	5V differential,0~500kHz 24V single-ended,0~200kHz z	--

2.1.4 Drive Dimension

• 200W/400W

ELP-D Series
 ELP-RS Series
 ELP-EC Series

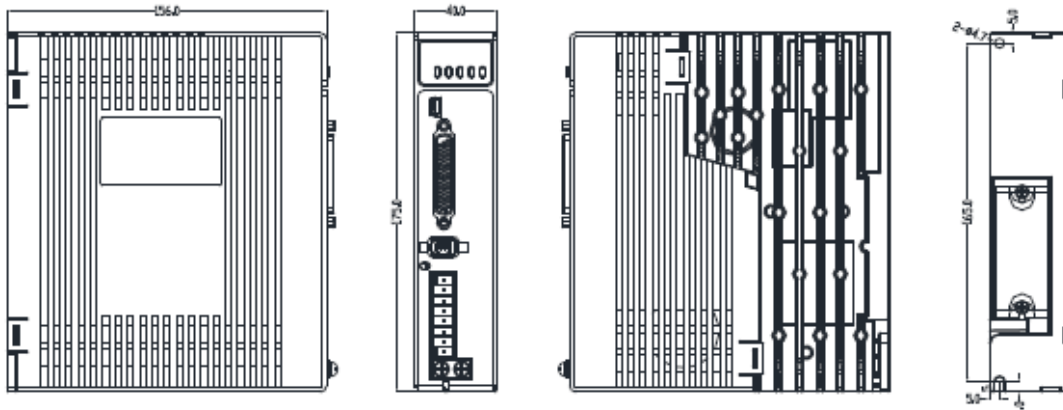

• 750W/1000W

ELP-D Series
 ELP-RS Series
 ELP-EC Series

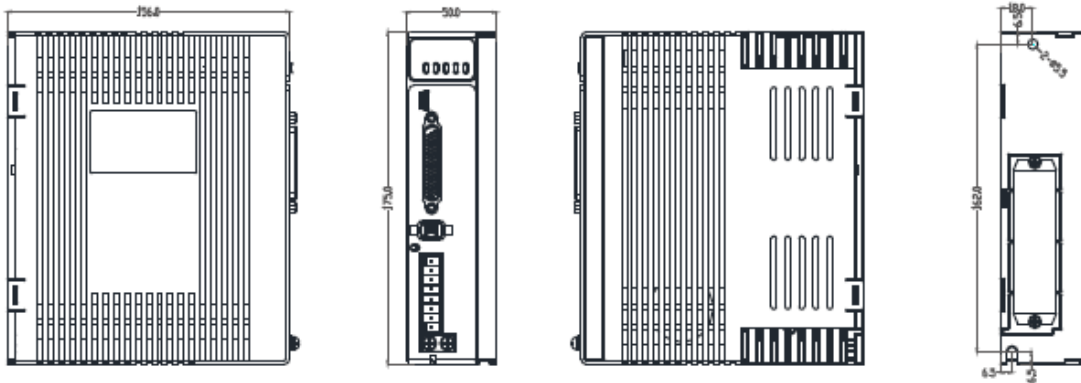

• 1500W/2000W

ELP-RS Series
 ELP-EC Series

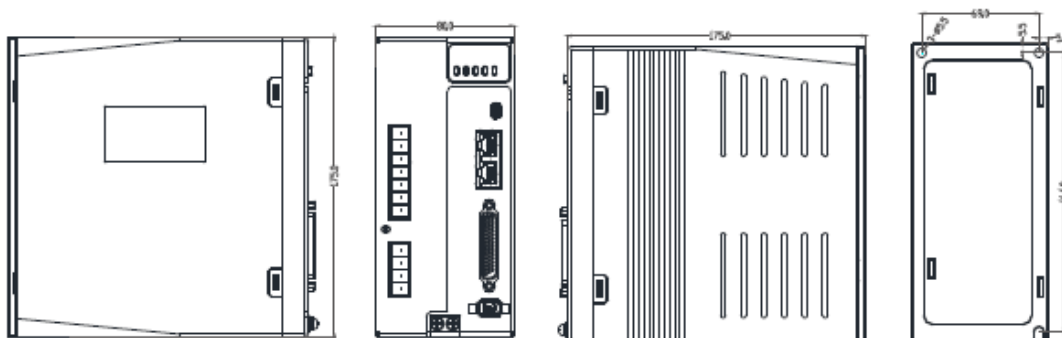

2.2 Motor Description

2.2.1 Model Designation

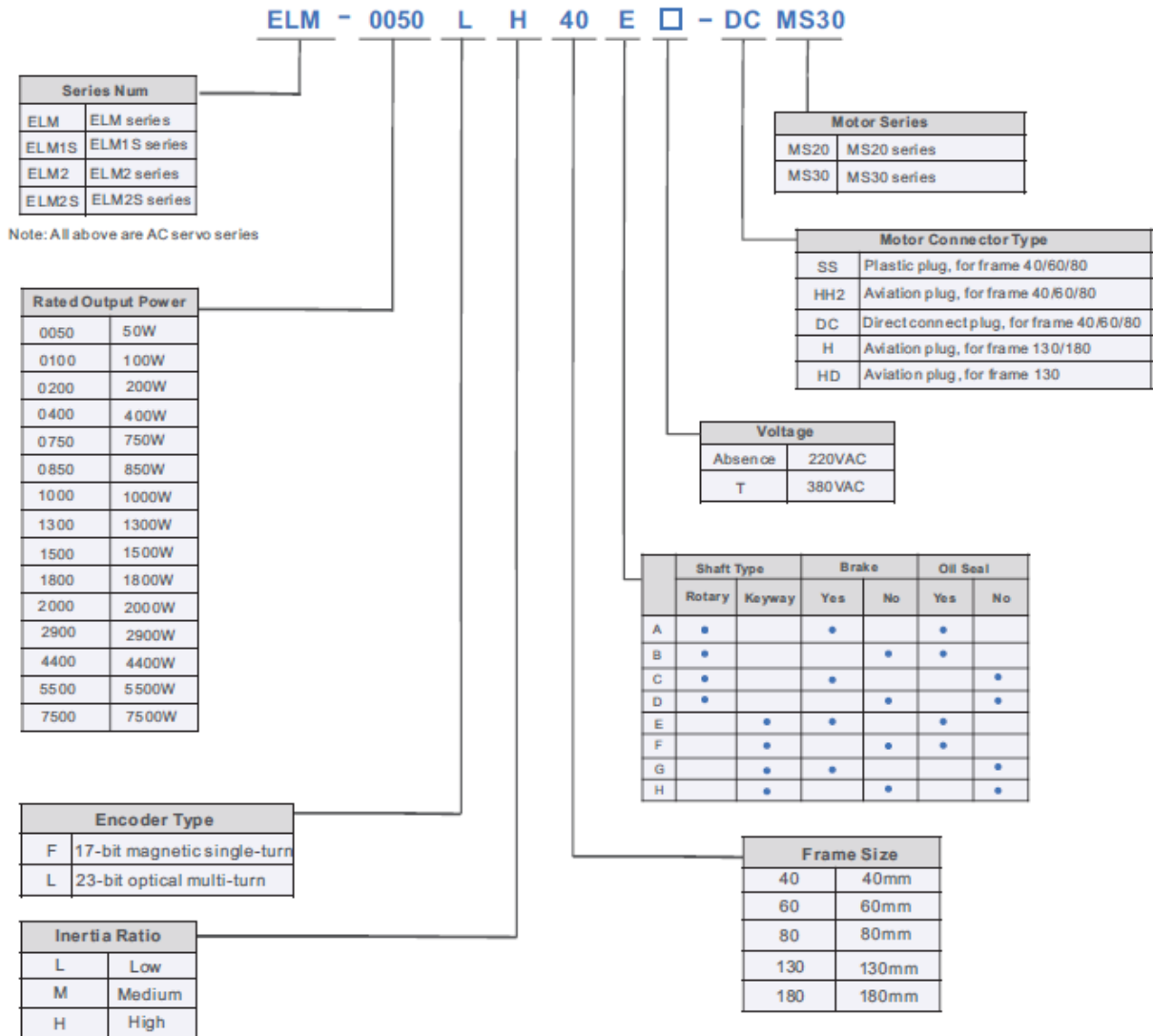

2.2.2 Motor Specification

2.2.2.1 Servo Motor with 17-bit Magnetic Single-turn Encoder for Frame 40/60/80

ELM Model	ELM1S-0050	ELM1S-0100	ELM1S-0200	ELM1S-0400	ELM1S-0750	ELM1S-1000
		FH40E-**	FH40E-**	FH60E-**	FH60E-**	FH80E-**
ELM Model	ELM1S-0050	ELM1S-0100	ELM1S-0200	ELM1S-0400	ELM1S-0750	ELM1S-1000
	FH40F-**	FH40F-**	FH60F-**	FH60F-**	FH80F-**	FH80F-**
Frame Size (mm)	40		60		80	
Rated Power (W)	50	100	200	400	750	1000

Rated Voltage (V)		220						
Rated Torque (N m)		0.16	0.32	0.64	1.27	2.39	3.19	
Peak Torque (N m)		0.48	0.96	2.24	4.46	8.37	11.2	
Rated Current (Arms)		0.85	0.85	1.5	2.1	4.1	5.7	
Peak Current (Arms)		2.97	2.97	4.7	7.35	13.4	17.7	
Rated Speed (r/min)		3000	3000	3000	3000	3000	3000	
Peak Speed (r/min)		6000	6000	6000	6000	6000	6000	
Inertia (kg m²10⁻⁴)	Without Brake	0.0355	0.062	0.29	0.56	1.5	2.03	
	With Brake	0.0456	0.0721	0.31	0.58	1.65	2.13	
Mass (kg)	Without Brake	0.32	0.46	0.9	1.3	2.12	2.7	
	With Brake	0.54	0.68	1.3	1.55	2.7	3.2	
Permissible Load to Shaft (N)	Radial	147	147	245	245	392	392	
	Axial	88	88	74	74	147	147	
Plug Type		SS Plug and HH2 Plug						
Matching Cable	Motor Cable	For Motor with SS Plug	CABLE-RZ*M*-S(V3.0)			For Motor with HH2 Plug	CABLE-RZH*M*-113-TS (For Motor without Brake)	
	Encoder Cable		CABLE-7BM*M*-Z(V3.0)				CABLE-RZSH*M*-113-TS (For Motor with Brake)	
	Brake Cable		CABLE-SC*M*-S(V3.0)				CABLE-BMH*M*-113-TS	
						/		

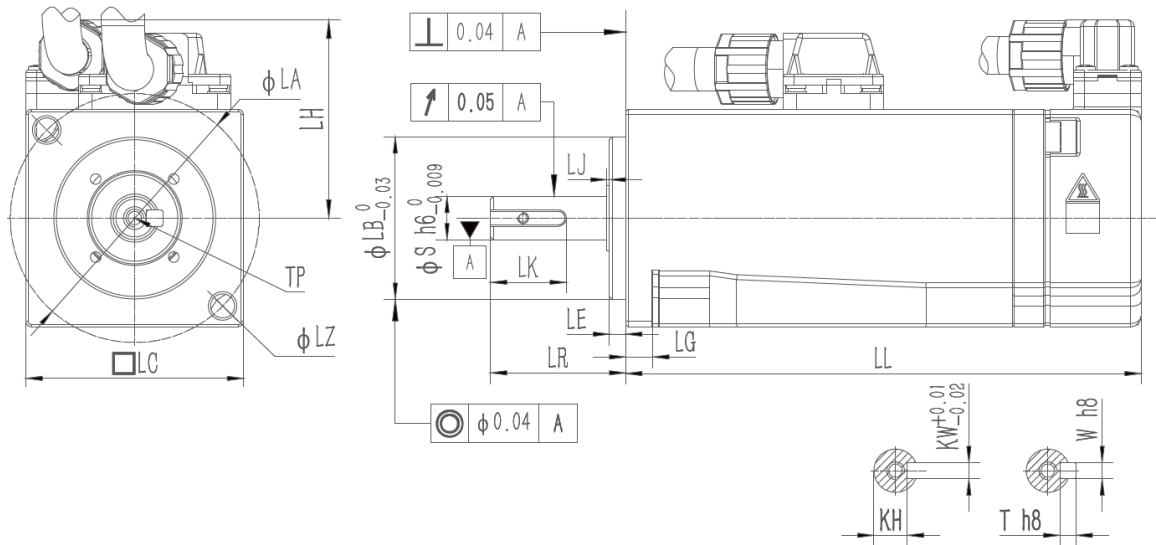

Model	LL	LC	LR	LA	LZ	LH	LG	LE	LJ	S	LB	TP	LK	KH	KW	W	T
ELM1S-0050FH40F-***	56.7	40	25	46	4.5	35MAX	5	3	3	8	30	M3×8	14	6.2	3	3	3
ELM1S-0050FH40E-***	84	40	25	46	4.5	35MAX	5	3	3	8	30	M3×8	14	6.2	3	3	3
ELM1S-0100FH40F-***	67.7	40	25	46	4.5	35MAX	5	3	3	8	30	M3×8	14	6.2	3	3	3
ELM1S-0100FH40E-***	95	40	25	46	4.5	35MAX	5	3	3	8	30	M3×8	14	6.2	3	3	3
ELM1S-0200FH60F-***	71.6	60	30	70	5.5	45MAX	6.6	3	3	14	50	M5×12	22.5	11	5	5	5
ELM1S-0200FH60E-***	100.9	60	30	70	5.5	45MAX	6.6	3	3	14	50	M5×12	22.5	11	5	5	5
ELM1S-0400FH60F-***	88.8	60	30	70	5.5	45MAX	6.6	3	3	14	50	M5×12	22.5	11	5	5	5
ELM1S-0400FH60E-***	118.1	60	30	70	5.5	45MAX	6.6	3	3	14	50	M5×12	22.5	11	5	5	5

ELM1S-0750FH80F-**	90.9	80	35	90	6.5	55MAX	8.1	3	3	19	70	M5×15	25	15.5	6	6	6
ELM1S-0750FH80E-**	121.9	80	35	90	6.5	55MAX	8.1	3	3	19	70	M5×15	25	15.5	6	6	6
ELM1S-1000FH80F-**	90.9	80	35	90	6.5	55MAX	8.1	3	3	19	70	M5×15	25	15.5	6	6	6
ELM1S-1000FH80E-**	121.9	80	35	90	6.5	55MAX	8.1	3	3	19	70	M5×15	25	15.5	6	6	6

2.2.2.2 Servo Motor with 23-bit Optical Multi-turn Encoder for Frame 40/60/80

ELM Model		ELM2-0050L	ELM2-0100L	ELM2-0200L	ELM2-0400L	ELM2-0750L	ELM2-1000L	
		H40*-SS	H40*-SS	H60*-SS	H60*-SS	H80*-SS	H80*-SS	
		ELM2S-0050	ELM2S-0100	ELM2S-0200	ELM2S-0400	ELM2S-0750	ELM2S-1000	
		LH40*-DC	LH40*-DC	LH60*-DC	LH60*-DC	LH80*-DC	LH80*-DC	
Frame Size (mm)		40		60		80		
Rated Power (W)		50	100	200	400	750	1000	
Rated Voltage (V)		220						
Rated Torque (N m)		0.16	0.32	0.64	1.27	2.39	3.19	
Peak Torque (N m)		0.48	0.96	2.24	4.46	8.37	11.2	
Rated Current (Arms)		0.85	0.85	1.5	2.1	4.1	5.7	
Peak Current (Arms)		2.97	2.97	4.7	7.35	13.4	17.7	
Rated Speed (r/min)		3000	3000	3000	3000	3000	3000	
Peak Speed (r/min)		6000	6000	6000	6000	6000	6000	
Inertia (kg m²10⁻⁴)	Without Brake	0.0355	0.062	0.29	0.56	1.5	2.03	
	With Brake	0.0456	0.0721	0.31	0.58	1.65	2.13	
Mass (kg)	Without Brake	0.32	0.46	0.9	1.3	2.12	2.7	
	With Brake	0.54	0.68	1.3	1.55	2.7	3.2	
Permissible Load to Shaft (N)	Radial	147	147	245	245	392	490	
	Axial	88	88	74	74	147	196	
Plug Type		SS Plug and DC Plug						
Matching Cable	Motor Cable	For Motor with SS Plug	CABLE-RZ*M*-S(V3.0)			For Motor with DC Plug	CABLE-RZH*M*-114-TS (For Motor without Brake)	
	Encoder Cable		CABLE-7BMA*M*-Z(V3.0)				CABLE-RZSH*M*-114-TS (For Motor with Brake)	
	Brake Cable		CABLE-SC*M*-S(V3.0)				CABLE-BMAH*M*-124-TS	
						/		

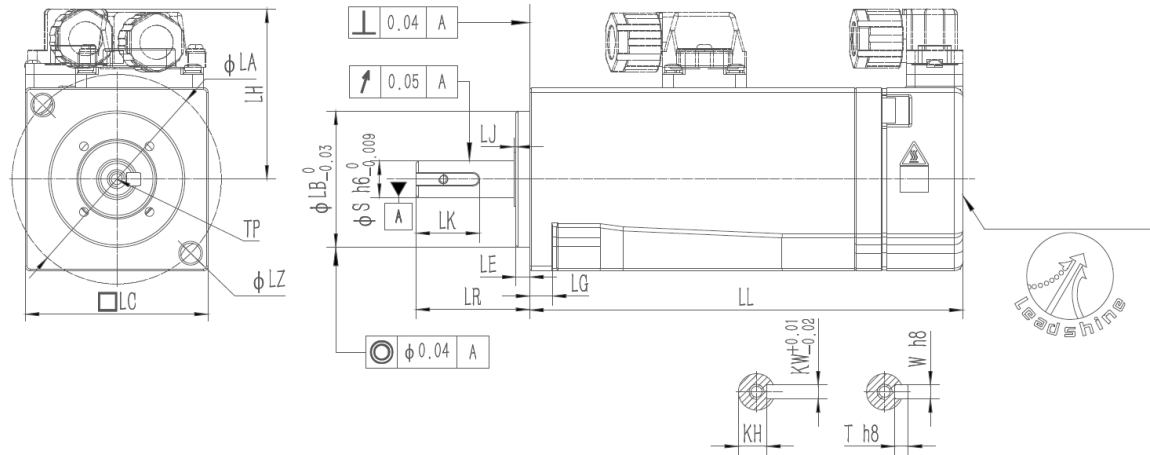

Model	LL	LC	LR	LA	LZ	LH	LG	LE	LJ	S	LB	TP	LK	KH	KW	W	T
ELM2*-0050LH40F-**	56.7	40	25	46	4.5	35MAX	5	3	3	8	30	M3×8	14	6.2	3	3	3
ELM2*-0050LH40E-**	84	40	25	46	4.5	35MAX	5	3	3	8	30	M3×8	14	6.2	3	3	3
ELM2*-0100LH40F-**	67.7	40	25	46	4.5	35MAX	5	3	3	8	30	M3×8	14	6.2	3	3	3
ELM2*-0100LH40E-**	95	40	25	46	4.5	35MAX	5	3	3	8	30	M3×8	14	6.2	3	3	3
ELM2*-0200LH60F-**	71.6	60	30	70	5.5	45MAX	6.6	3	3	14	50	M5×12	22.5	11	5	5	5
ELM2*-0200LH60E-**	100.9	60	30	70	5.5	45MAX	6.6	3	3	14	50	M5×12	22.5	11	5	5	5
ELM2*-0400LH60F-**	88.8	60	30	70	5.5	45MAX	6.6	3	3	14	50	M5×12	22.5	11	5	5	5
ELM2*-0400LH60E-**	118.1	60	30	70	5.5	45MAX	6.6	3	3	14	50	M5×12	22.5	11	5	5	5
ELM2*-0750LH80F-**	90.9	80	35	90	6.5	55MAX	8.1	3	3	19	70	M5×15	25	15.5	6	6	6
ELM2*-0750LH80E-**	121.9	80	35	90	6.5	55MAX	8.1	3	3	19	70	M5×15	25	15.5	6	6	6
ELM2*-1000LH80F-**	103.9	80	35	90	6.5	55MAX	8.1	3	3	19	70	M5×15	25	15.5	6	6	6
ELM2*-1000LH80E-**	134.9	80	35	90	6.5	55MAX	8.1	3	3	19	70	M5×15	25	15.5	6	6	6

2.2.2.3 Servo Motor with 23-bit Optical Multi-turn Encoder for Frame 130

ELM Model	ELM-1000 LM130E-H	ELM-1500 LM130E-H	ELM-2000 LM130E-H	ELM-0850 LH130E-H D	ELM-1300 LH130E-H D	ELM-1800 LH130E-H D	ELM-1800 LH130ET- H
	ELM-1000 LM130F-H	ELM-1500 LM130F-H	ELM-2000 LM130F-H	ELM-0850 LH130F-H D	ELM-1300 LH130F-H D	ELM-1800 LH130F-H D	ELM-1800 LH130FT- H
Frame Size (mm)	130						
Rated Power (W)	1000	1500	2000	850	1300	1800	1800
Rated Voltage (V)	220						380
Rated Torque (N m)	4	6	7.7	5.39	8.4	11.5	11.5
Peak Torque (N m)	10	15	19.3	13.5	21	28.75	34.5
Rated Current (Arms)	4	6	7.5	6.5	9.5	9	8.2
Peak Current (Arms)	10	15	18.8	16.3	23.8	22.5	24.6
Rated Speed (r/min)	2500	2500	2500	1500	1500	1500	1500
Peak Speed (r/min)	3000	3000	3000	3000	3000	2000	3000

Inertia (kg m ² ·10 ⁻⁴)	Without Brake	8.5	12.6	15.3	13.88	20.6	20.59	20.59	
	With Brake	8.95	14.08	16.8	15.78	22.3	22.26	22.26	
Mass (kg)	Without Brake	6.2	7.4	8.3	5.6	7.5	7.5	7.5	
	With Brake	8.3	9.5	11	6.9	8.8	8.8	8.8	
Permissible Load to Shaft (N)	Radial	490	490	490	490	490	490	490	
	Axial	196	196	196	196	196	196	196	
Plug Type		H Plug and HD Plug							
Matching Cable	Motor Cable	For Motor with H	CABLE-RZ*M*-H(V2.0)			For Motor with HD Plug	CABLE-RZ*M*-HD(V2.0)		
	Encoder Cable		CABLE-7BMA*M*-HZ(V3.0)				CABLE-7BMA*M*-HD(V3.0)		
	Brake Cable	Plug	CABLE-SC*M*-H(V3.0)			CABLE-SC*M*-HD(V3.0)			

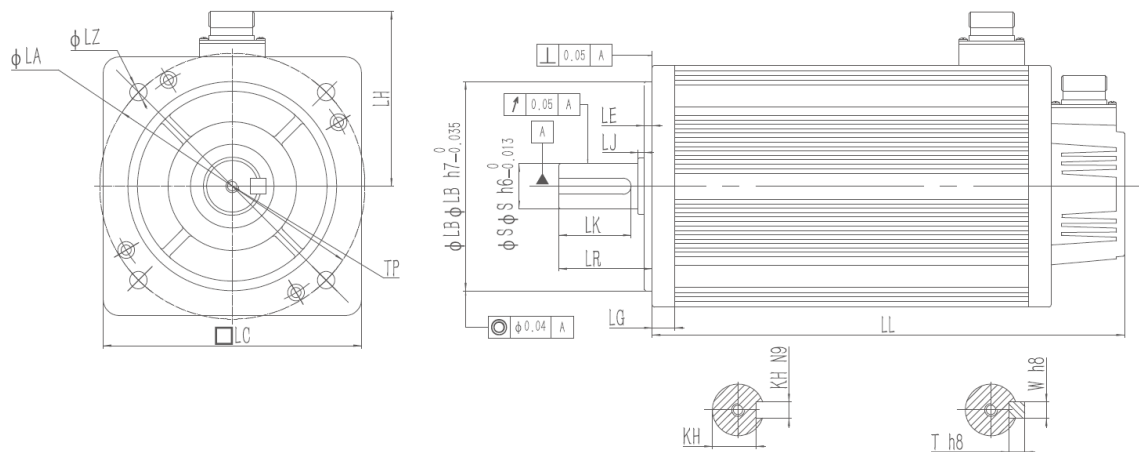
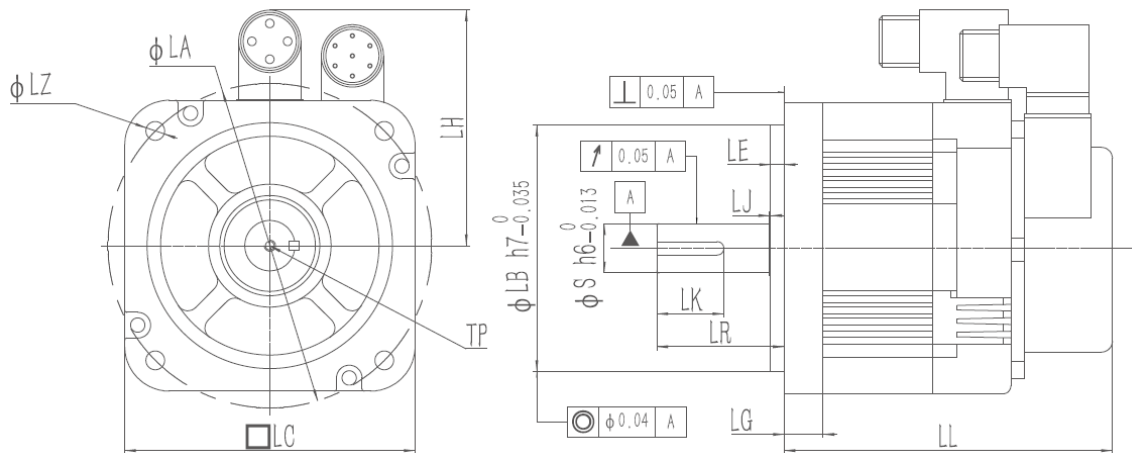

Model	LL	LC	LR	LA	LZ	LH	LG	LE	LJ	S	LB	TP	LK	KH	KW	W	T
ELM-0850LH130F-HD	147	130	57	145	8.5	106	17.5	6	0.5	19	110	M5×12	30	16	5	5	5
ELM-0850LH130E-HD	172	130	57	145	8.5	106	17.5	6	0.5	19	110	M5×12	30	16	5	5	5
ELM-1300LH130F-HD	168	130	57	145	8.5	106	17.5	6	0.5	22	110	M5×12	30	18.5	6	6	6
ELM-1300LH130E-HD	192	130	57	145	8.5	106	17.5	6	0.5	22	110	M5×12	30	18.5	6	6	6

ELM-1800LH130F*-HD	195	130	57	145	8.5	106	17.5	6	0.5	24	110	M5×12	30	19	8	8	8
ELM-1800LH130E*-HD	219	130	57	145	8.5	106	17.5	6	0.5	24	110	M5×12	30	19	8	8	8
ELM-1000LM130F-H	166	131	57	145	9	111	14	5	2	22	110	M6×20	40	18.5	6	6	6
ELM-1000LM130E-H	223	131	57	145	9	111	14	5	2	22	110	M6×20	40	18.5	6	6	6
ELM-1500LM130F-H	179	131	57	145	9	111	14	5	2	22	110	M6×20	40	18.5	6	6	6
ELM-1500LM130E-H	236	131	57	145	9	111	14	5	2	22	110	M6×20	40	18.5	6	6	6
ELM-2000LM130F-H	192	131	57	145	9	111	14	5	2	22	110	M6×20	40	18.5	6	6	6
ELM-2000LM130E-H	270	131	57	145	9	111	14	5	2	22	110	M6×20	40	18.5	6	6	6

2.2.2.4 Servo Motor with 23-bit Optical Multi-turn Encoder for Frame 180

ELM Model	ELM-2900LM180ET- H		ELM-4400LM180ET- H		ELM-5500LM180ET- H		ELM-7500LM180ET- H		
	ELM-2900LM180FT- H		ELM-4400LM180FT- H		ELM-5500LM180FT- H		ELM-7500LM180FT- H		
Frame Size (mm)	180								
Rated Power (W)	2900		4400		5500		7500		
Rated Voltage (V)	380								
Rated Torque (N m)	18.6		28.4		35		48		
Peak Torque (N m)	46.5		71.1		87.5		119		
Rated Current (A)	11.8		15.7		20.6		25.7		
Peak Current (A)	29.5		39.3		51.5		64.5		
Rated Speed (r/min)	1500		1500		1500		1500		
Peak Speed (r/min)	3000		3000		3000		3000		
Inertia (kg m²10⁻⁴)	Without Brake	56.8		78.2		109		130	
	With Brake	65.3		86		118		140	
Mass (kg)	Without Brake	16.3		21.4		25.8		32.3	
	With Brake	21.8		26.5		31.1		37.6	
Permissible Load to Shaft (N)	Radial	1470		1750		1750		1750	
	Axial	490		580		580		580	
Plug Type	H Plug								
Matching Cable	Motor Cable	CABLE-RZA*M*-H-180(V1.0)		For Motor of 2900W					
		CABLE-RZB*M*-H-180(V1.0)		For Motor of 4400W/5500W/7500W					
	Encoder Cable	CABLE-7BMA*M*-HZ-180(V1.0)							
	Brake Cable	CABLE-SC*M*-H-180(V1.0)							

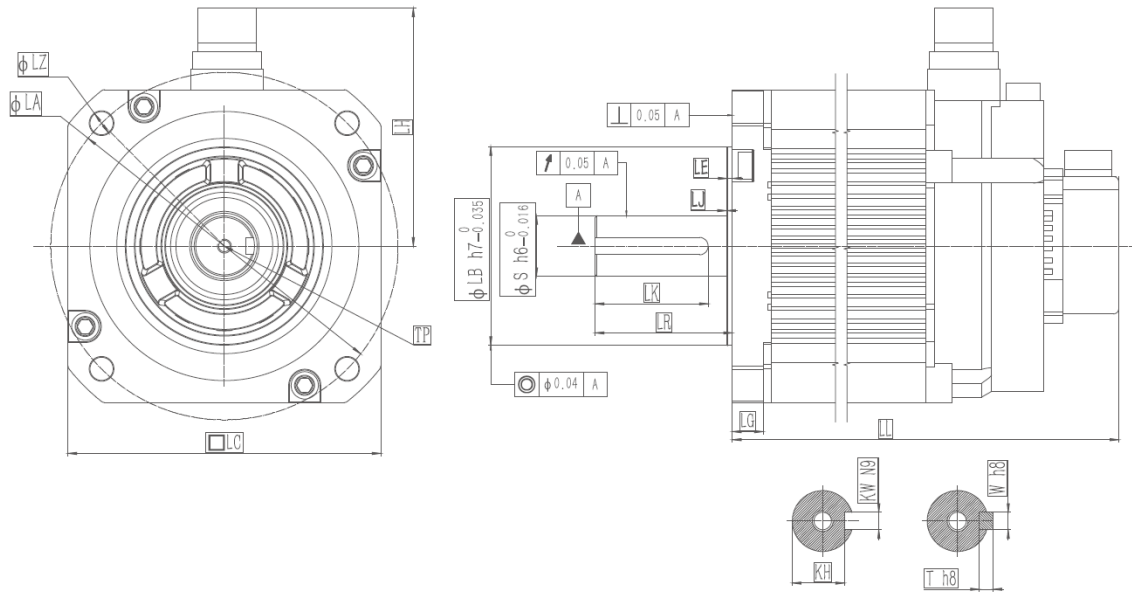

Model	LL	LC	LR	LA	LZ	LH	LG	LE	LJ	S	LB	TP	LK	KH	KW	W	T
ELM-2900LM180FT-H	201	180	79	200	4-Φ13.5	134	18	3.2	0.3	35	114	M12×25	65	30	10	10	8
ELM-2900LM180ET-H	249	180	79	200	4-Φ13.5	134	18	3.2	0.3	35	114	M12×25	65	30	10	10	8
ELM-4400LM180FT-H	230	180	79	200	4-Φ13.5	134	18	3.2	0.3	35	114	M12×25	65	30	10	10	8
ELM-4400LM180ET-H	278	180	79	200	4-Φ13.5	134	18	3.2	0.3	35	114	M12×25	65	30	10	10	8
ELM-5500LM180FT-H	257	180	113	200	4-Φ13.5	134	18	3.2	0.3	42	114	M16×32	96	37	12	12	8
ELM-5500LM180ET-H	345	180	113	200	4-Φ13.5	134	18	3.2	0.3	42	114	M16×32	96	37	12	12	8
ELM-7500LM180FT-H	297	180	113	200	4-Φ13.5	134	18	3.2	0.3	42	114	M16×32	96	37	12	12	8
ELM-7500LM180ET-H	345	180	113	200	4-Φ13.5	134	18	3.2	0.3	42	114	M16×32	96	37	12	12	8

2.2.3 N-T Characteristics

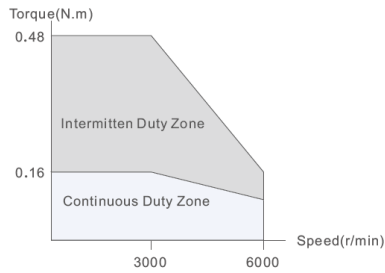
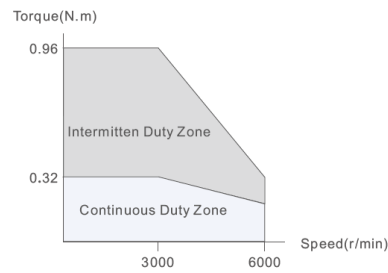
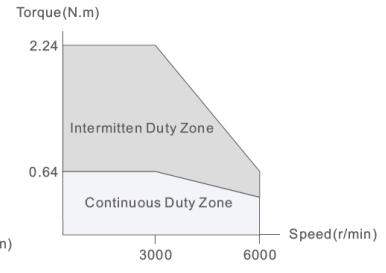
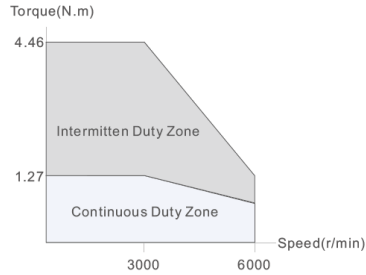
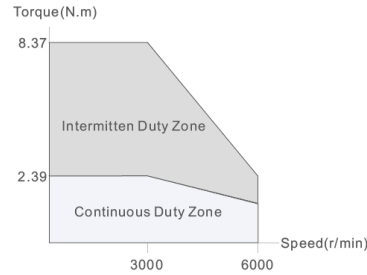
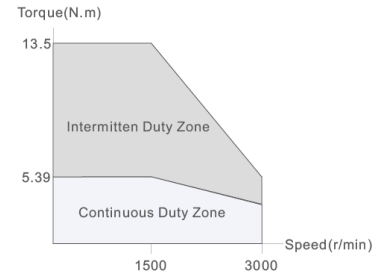
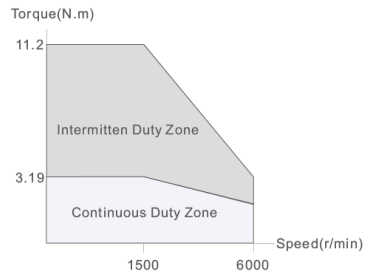
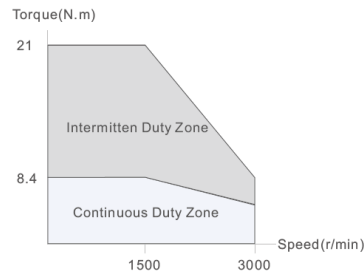
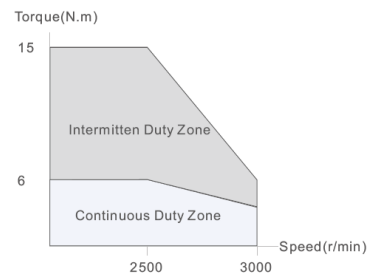
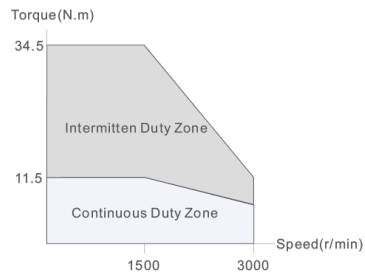
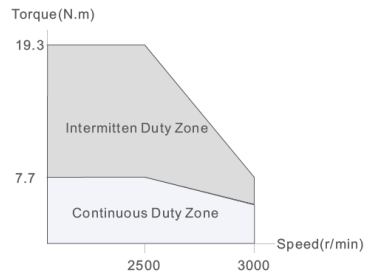
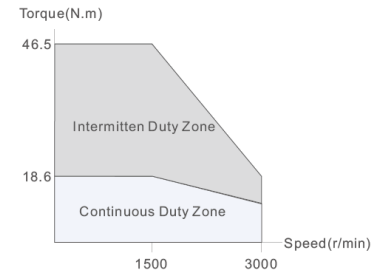
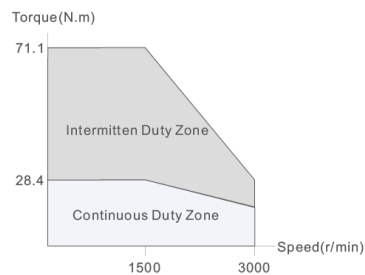
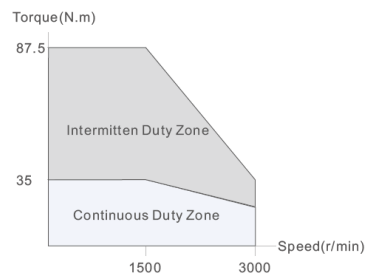
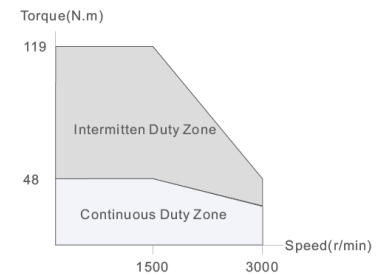
50W Motor

100W Motor

200W Motor

400W Motor

750W Motor

850W Motor

1000W Motor

1300W Motor

1500W Motor

1800W Motor

2000W Motor

2900W Motor

4400W Motor

5500W Motor

7500W Motor

2.3 Cable Description

2.3.1 Matching Cable

➤ **Motor Cable**

- ◆ **Length options:** 1.5M, 3M, 5M, 7M, 10M, 13M
- ◆ **Connector options:** Plastic plug Optional: Injection plug



➤ **Encoder Cable**

- ◆ **Length options:** 1.5M, 3M, 5M, 7M, 10M, 13M
- ◆ **Connector options:** Plastic plug Optional: Injection plug



➤ **Brake Cable**

- ◆ **Length options:** 1.5M, 3M, 5M, 7M, 10M, 13M
- ◆ **Connector options:** Plastic plug Optional: Injection plug



➤ **GUI Debug Cable**

- ◆ Connect the drive to computer
- ◆ The interface standard is USB
- ◆ Model: CABLE-USB1M5, CABLE-L6TS1M5



➤ **RS485/ EtherCAT Communication Cable**

- ◆ **Model:** CABLE-TX0M2-BUS
- ◆ **Length options:** 1.5M, 3M, 5M, 7M, 10M, 13M



2.3.2 Cable Detail

2.3.2.1 Cable with SS Plug for Frame 40/60/80

➤ **CABLE-RZ*M*-S1(V3.0) Motor Cable**

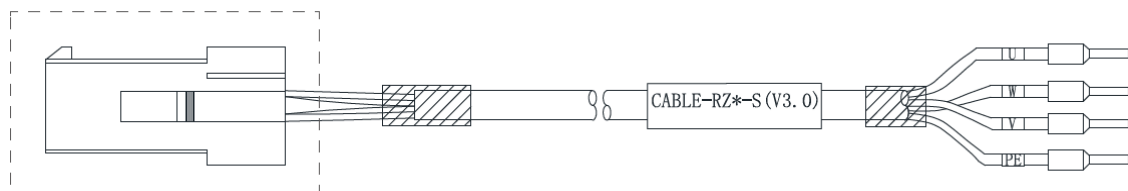

Material		Part No.	Quantity
Motor Cable Part	Plastic Shell	11600371	1
	Pin Needle	11600353	4

➤ **CABLE-7BM*M*-Z(V3.0) Encoder Cable**

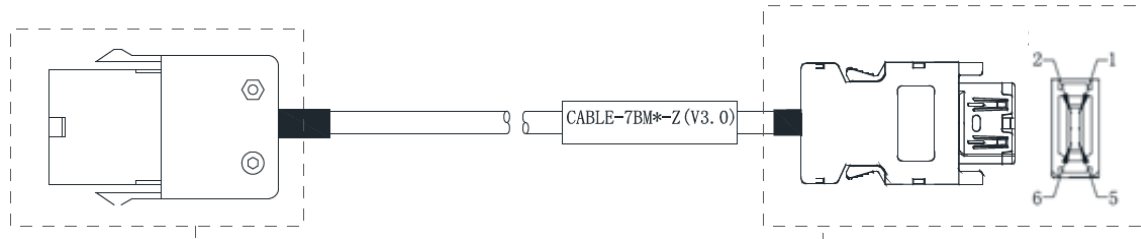

Material		Part No.	Quantity
Encoder Cable Parts	Plastic Shell	11600372	1
	Pin Needle	11600354	5
Plug Connected to Drive		11600383	1

➤ **CABLE-SC*M*-S1(V3.0) Brake Cable**

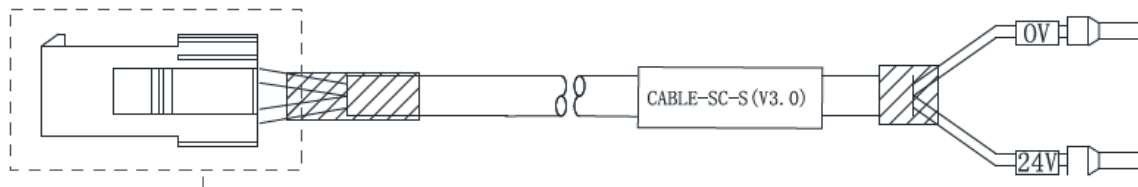

Material		Part No.	Quantity
Brake Cable Parts	Plastic Shell	11600369	1
	Pin Needle	11600353	2

2.3.2.2 Cable with HH2 Plug for Frame 40/60/80

➤ **CABLE-RZH*M*-113-TS Motor Cable for Motor without Brake**

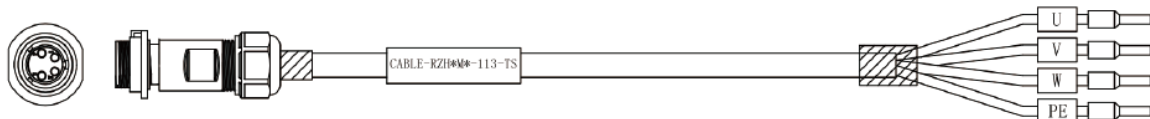

Material		Part No.	Quantity
Motor Cable Parts	Female Plug for Motor Cable	11600548	1
	Male Plug for Motor Cable	11600549	1

➤ **CABLE-TZSH*M*-113-TS Motor Cable for Motor with Brake**

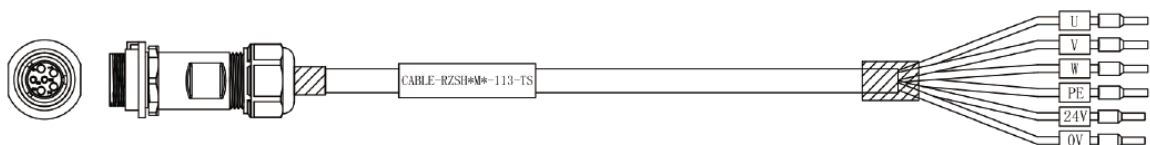

Material	Part No.	Quantity
----------	----------	----------

Motor Cable Parts	Female Plug for Motor Cable	11600546	1
	Male Plug for Motor Cable	11600547	1

➤ **CABLE-BMH*M*-113-TS Encoder Cable**

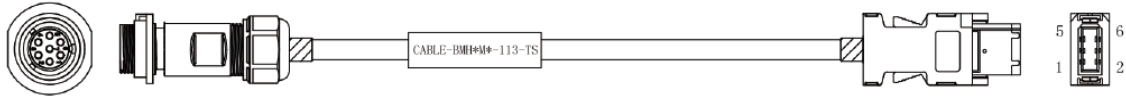

	Material	Part No.	Quantity
Encoder Cable Parts	Female Plug for Encoder Cable	11600546	1
	Male Plug for Encoder Cable	11600547	1
	Plug Connected to Drive	11600383	1

2.3.2.3 Cable with DC Plug for Frame 40/60/80

➤ **CABLE-RZH*M*-114-TS Motor Cable for Motor without Brake**

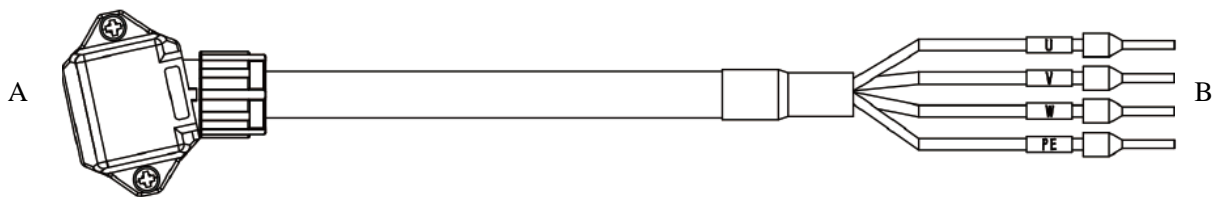



Diagram	A-end	Color	B-end
	1	Blue	U
	2	Red	W
	3	Black	V
	4	Yellow/Green	PE

➤ **CABLE-RZH*M*-114-TS Motor Cable for Motor with Brake**

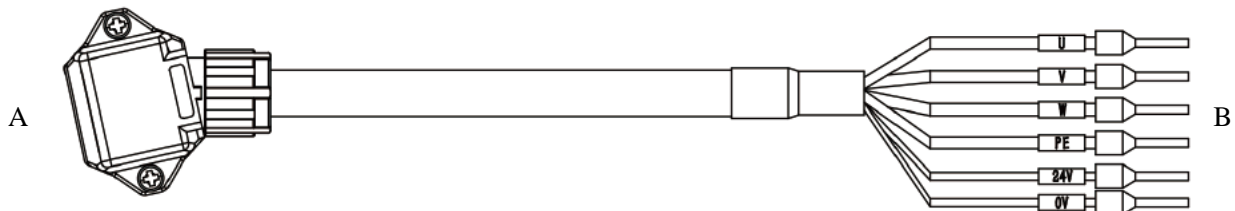
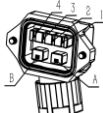

Diagram	A-end	Color	B-end
	1	Blue	U
	2	Red	W
	3	Black	V
	4	Yellow/Green	PE
	5	Black	0V
	6	Red	24V

➤ **CABLE-BMAH*M*-124-TS Encoder Cable**

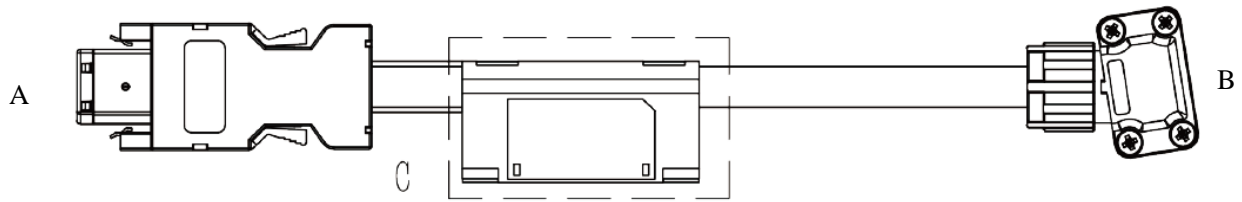
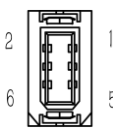
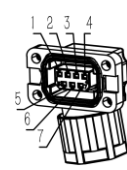
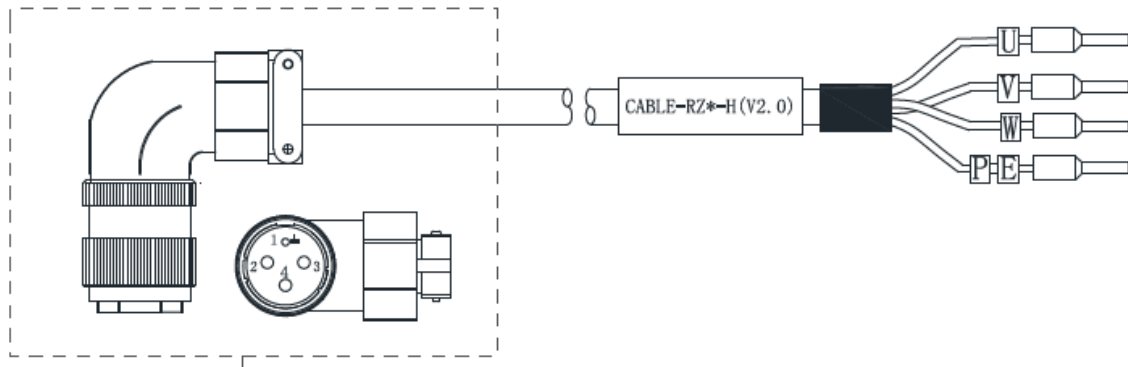

Diagram	A-end	Definition	B-end	Diagram	C-end
	1	PE	1		
	2	5V	2		
	3	0V	3		
	4	SD+	4		
	5	SD-	5		
	6	BAT+	6		
	7	BAT-	7		
					1
					2

2.3.2.4 Cable with H Plug for Frame 130

➤ **CABLE-RZ*M*-H(V2.0) Motor Cable**



	Material	Part No.	Quantity
Motor Cable Parts	Aviation Plug for Motor Cable	11600072	1

➤ **CABLE-7BM*M*-HZ(V3.0) Encoder Cable**

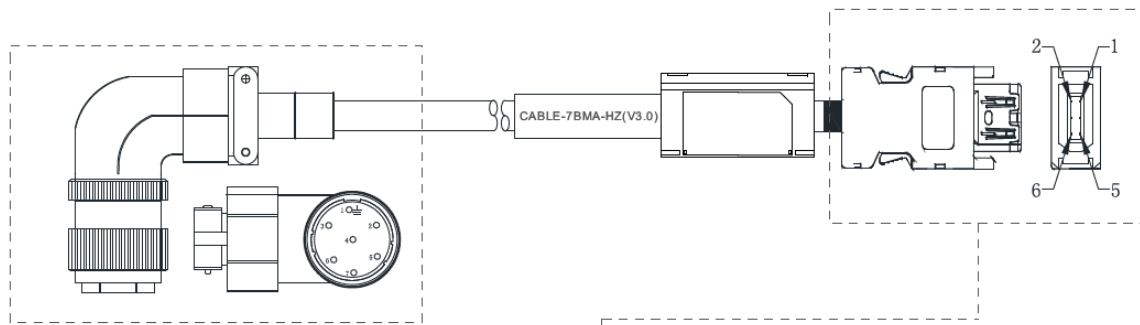

Material		Part No.	Quantity
Encoder Cable Parts	Aviation Plug for Encoder Cable	11600076	1
	Plug Connected to Drive	11600383	1

➤ **CABLE-SC*M*-H(V3.0) Brake Cable**

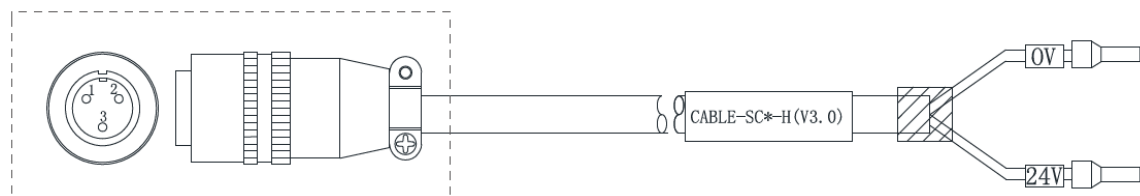

Material		Part No.	Quantity
Brake Cable Parts	Aviation Plug for Brake Cable	11600070	1

2.3.2.5 Cable with HD Plug for Frame 130

➤ **CABLE-RZ*M*-HD(V2.0) Motor Cable**

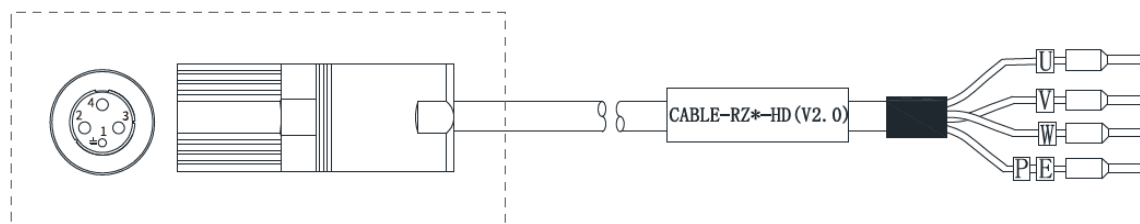

Material		Part No.	Quantity
Motor Cable Parts	Aviation Plug for Motor Cable	11600077	1

➤ **CABLE-7BM*M*-HD(V3.0) Encoder Cable**

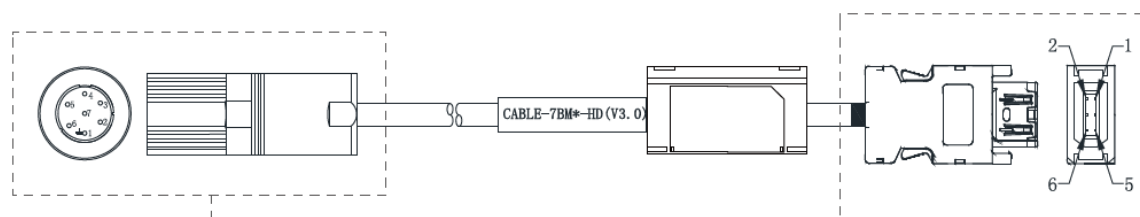

Material		Part No.	Quantity

Encoder Cable Parts	Aviation Plug for Encoder Cable	11600079	1
	Plug Connected to Drive	11600383	1

➤ **CABLE-SC*M*-HD(V3.0) Brake Cable**

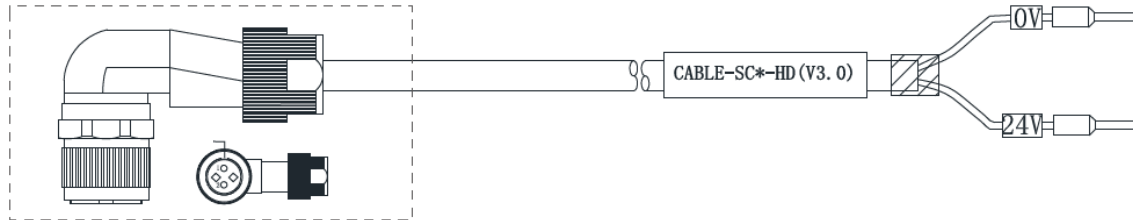

	Material	Part No.	Quantity
Brake Cable Parts	Aviation Plug for Brake Cable	11600078	1

2.3.2.6 Cable with H Plug for Frame 180

➤ **CABLE-RZ*M*-H(V2.0) Motor Cable**

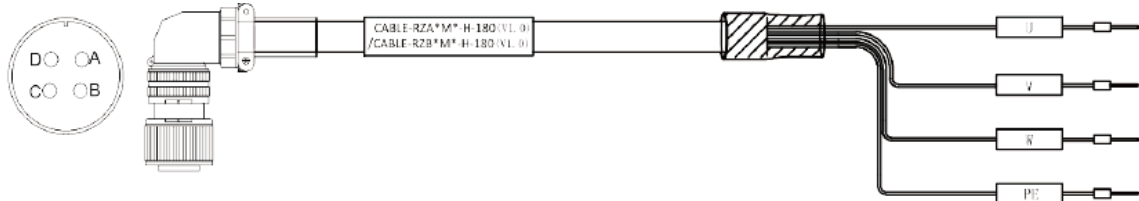

	Material	Part No.	Quantity
Motor Cable Parts	Aviation Plug for Motor Cable	11600980	1

➤ **CABLE-7BMA*M*-HZ-180(V1.0) Encoder Cable**

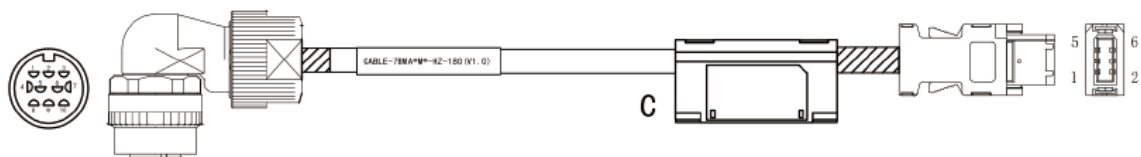

	Material	Part No.	Quantity
Encoder Cable Parts	Aviation Plug for Encoder Cable	11600979	1
	Plug Connected to Drive	11600383	1
	Battery Box	82600020	1

➤ **CABLE-SC*M*-H-180(V1.0) Brake Cable**

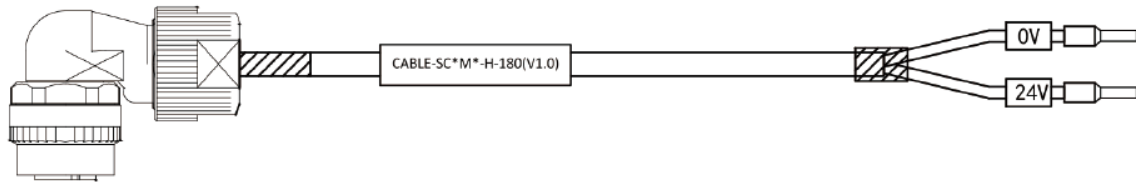

	Material	Part No.	Quantity
Brake Cable Parts	Aviation Plug for Brake Cable	11600978	1

Chapter 3 Installation

3.1 Storage and Installation Condition

Table 3.1 Environment of Servo Drive

Item	ELP Series Drive
Ambient Temperature	0°C~55°C (free from freezing)
Ambient Humidity	20%~90%RH (free from condensation)
Storage Temperature	-20°C~80°C (free from freezing)
Storage Humidity	20%~90%RH (free from condensation)
Vibration	Less than 4.9m/s ² (0.5G) 10-60Hz (Non-continuous working)
Altitude	Lower than 1000m
Impact	Less than 19.6m/s ²
Protection Class	IP20

Table 3.2 Environment of Servo Motor

Item	ELP Series Motor
Ambient Temperature	0°C~40°C (free from freezing)
Ambient Humidity	20%~90%RH (free from condensation)
Storage Temperature	-20°C~60°C (free from freezing)
Storage Humidity	20%~90%RH (free from condensation)
Vibration	Less than 49m/s ² (5G)
Altitude	Lower than 1000m
Impact	Less than 490m/s ² (50G)
Protection Class	IP65 (ELM2S series up to IP67)

3.2 Servo Drive Installation



Notice

- Sufficient safeguarding grade is necessary for installation in control cabinet.
- Specified direction, intervals and good cooling condition are necessary for installation.
- Don't install them on inflammable substance or near it to prevent fire hazard.

Here is the installation diagram:

- (1) Install in vertical position, and reserve enough space around the servo drive for ventilation.

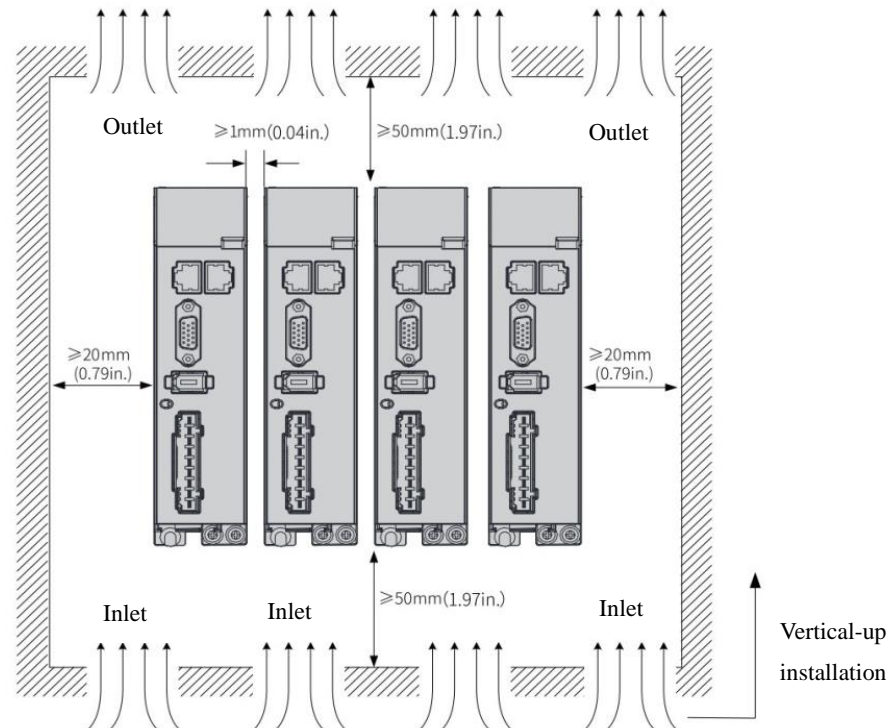

- (2) The user may install the product in the mode of bottom plate installation or panel installation, and the installation direction is perpendicular to the installation face. In order to ensure good heat dissipation conditions, at least 10MM of installation space should be set aside in the actual installation.
- (3) When mounting drive compactly, consider installation tolerances and leave at least 1MM between each two drive. Use it below 75% of the actual load rate.
- (4) Whenever lifting the product, two or more persons should hold it by metallic member, not by plastic member.
- (5) We have been making the best effort to ensure the highest quality, however, application of exceptionally large external noise disturbance and static electricity, or failure in input power, wiring and components may result in unexpected action. It is highly recommended that you make a fail-safe design and secure the safety in the operative range.
- (6) If stranded wires are used as the cable, bunch the conductors of the cable using rod terminals or round terminals. If stranded wires are used as they are, unexpected accidents such as an electric shock and short circuit or injury may result.
- (7) There might be a chance of smoke generation due to the failure of these products. Pay an extra attention when you apply these products in a clean room environment.
- (8) Be sure to install a no-fuse breaker in the power supply. In addition, be sure to ground the grounding terminal or grounding wire provided.

3.3 Servo Motor Installation



Notice

- Don't hold the product by the cable, motor shaft or encoder while transporting it.
- No knocking motor shaft or encoders, prevent motor by vibration or shock.
- The motor shaft can't bear the load beyond the limits.

- Motor shaft does not bear the axial load, radial load, otherwise you may damage the motor.
- Use a flexible with high stiffness designed exclusively for servo application in order to make a radial thrust caused by micro misalignment smaller than the permissible value.
- Installing must be steady, prevent drop from vibrating.

How to Install

You can mount the motor either horizontally or vertically as long as you observe the followings.

(1) Horizontal mounting

- Mount the motor with cable outlet facing downward for water/oil countermeasure.

(2) Vertical mounting

- Use the motor with oil seal (make-to-order in case of motor 750W or less) when mounting the motor with gear reducer to prevent the reducer oil/grease from entering to the motor.

Oil/Water Protection

(9) Don't submerge the motor cable to water or oil.

(10) Install the motor with the cable outlet facing downward.

(11) Avoid a place where the motor is always subjected to oil or water.

(12) Use the motor with an oil seal when used with the gear reducer, so that the oil may not enter to the motor through shaft

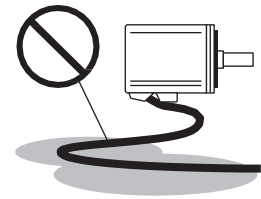

Stress to Cables

(1) Avoid a stress application to the cable outlet and connecting portion by bending or self-weight.

(2) Especially in an application where the motor itself travels, fix the junction cable into the bearer so that the stress by bending can be minimized.

(3) Take the cable bending radius as large as possible. (When you use our optional cable, Minimum R20mm)

Permissible Load to Output Shaft

(1) Design the mechanical system so that the applied radial load and/or thrust load to the motor shaft at installation and at normal operation can meet the permissible value specified to each model.

(2) Pay an extra attention when you use a rigid coupling. (Excess bending load may damage the shaft or deteriorate the bearing life.)

(3) Use a flexible coupling with high stiffness designed exclusively for servo application in order to make a radial thrust caused by micro misalignment smaller than the permissible value.

Notes on Installation

(1) Do not apply direct impact to the shaft by hammer while attaching/detaching a coupling to and from the motor shaft.

(2) (Or it may damage the encoder mounted on the other side of the shaft.)

(3) Make a full alignment. (Incomplete alignment may cause vibration and damage the bearing.)

(4) If the motor shaft is not electrically grounded, it may cause electrolytic corrosion to the bearing depending on the condition of the machine and its mounting environment, and may result in the bearing noise. Check and verification by customer is required.

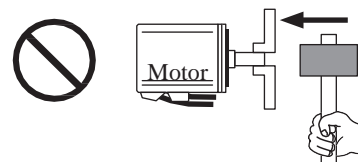

Chapter 4 Wiring



Warning

- The workers of participation in wiring or checking must possess sufficient ability to do this job.
- The wiring and checking must be going with power off after five minutes.



Caution

- Ground the earth terminal of the motor and drive without fail.
- The wiring should be connected after servo drive and servo motor installed correctly.

4.1 Wiring

4.1.1 Wire Gauge

(1) Power Supply Terminal TB

- Diameter:

Table 4.1 Power Wiring Specification

Drive	Wire Diameter (mm ² /AWG)			
	L1/L2/L3	P+/BR	U/V/W	PE
ELP-*0400Z	0.81/AWG18	2.1/AWG14	1.3/AWG16	2.1/AWG14
ELP-*0750Z	0.81/AWG18	2.1/AWG14	1.3/AWG16	2.1/AWG14
ELP-*1000Z	0.81/AWG18	2.1/AWG14	2.1/AWG14	2.1/AWG14
ELP-*1500Z	1.3/AWG16	2.6/AWG13	2.6/AWG13	2.6/AWG13
ELP-*2000Z	2.1/AWG14	2.6/AWG13	3.3/AWG12	2.6/AWG13

- Grounding: The grounding wire should be as thick as possible, drive servo motor the PE terminal point ground, ground resistance <100 Ω.
- Use noise filter to remove external noise from the power lines and reduce an effect of the noise generated by the servo drive.
- Install fuse (NFB) promptly to cut off the external power supply if drive error occurs.

(2) The control signal CN1, feedback signal CN2

- Cable diameter: Shielded cable (twisting shield cable would be better), the diameter $\geq 0.14\text{mm}^2$ (AWG24-26), the shield should be connected to FG terminal.
- Cable length: Cable length should be as short as possible and control cable CN1 is no more than 3 meters, the CN2 cable length of the feedback signal is no more than 20 meters.
- Wiring: Ensure being away from the wiring of power line to prevent interference input.
- Install a surge absorbing element for the relevant inductive element (coil), DC coil should be in parallel connection with freewheeling diode reversely; AC coil should be in parallel connection with RC snubber circuit.

(3) Regenerative resistor

- When the torque of the motor is opposite to the direction of rotation (common scenarios such as deceleration, vertical axis descent, etc.), energy will feedback from the load to the drive. At this time, the energy feedback is firstly received by the capacitor in the drive which makes the voltage of the capacitor rise. When voltage rises to a certain level, the excess energy needs to be consumed by the regenerative resistance.

The recommended regenerative resistor specifications for the ELP series are as follows:

Table 4.2 Regenerative Resistance Specification Sheet

Drive	Built-in Resistor Value (Ω)	Built-in Resistor Power (W)
ELP-*0400Z	100	50
ELP-*0750Z	50	50
ELP-*1000Z	50	100
ELP-*1500Z	50	100
ELP-*2000Z	50	100

Methods for determining regenerative resistance specification:

- Firstly, use the built-in resistor of the drive to run for a long time to observe if it can meet the requirements, ensure that the drive temperature $d33 < 60^{\circ}\text{C}$, the braking circuit does not alarm (Regeneration load factor $d14 < 80$), and the drive does not report over-voltage error.
- If the drive temperature is high, try to reduce the regenerative energy power, or add external resistor with same specification (While adding external resistor, built-in resistor should be removed).
- If the braking resistor burns out, try to reduce the regenerative energy power, or add external resistor with same specification or even higher specification (While adding external resistor, built-in resistor should be removed).
- If $d14$ value is too large or accumulates rapidly, it means the regenerative energy is too large, and built-in resistor cannot consume the generated energy, try to reduce the regenerative energy power, or add external resistor with higher specification.
- If drive reported over-voltage error, try to reduce the regenerative energy power, or add external resistor with smaller specification, or add parallel resistor.

(4) Brake cable

When connecting to motor with magnetic encoder (ELM1S series motors), it is necessary to pay attention to polarity of brake cable, otherwise it will cause the abnormal motor action such as alarm occurring, motor accuracy declining, abnormal motor vibration.



Attention

- Match the colors of the motor lead wires to those of the corresponding motor output terminals (U.V.W).
- Never start nor stop the servo motor with this magnetic contactor.
- Cable must be fixed steadily; avoid closing to radiator and motor to prevent reducing the properties of heat insulation.

4.1.2 Position Control Mode

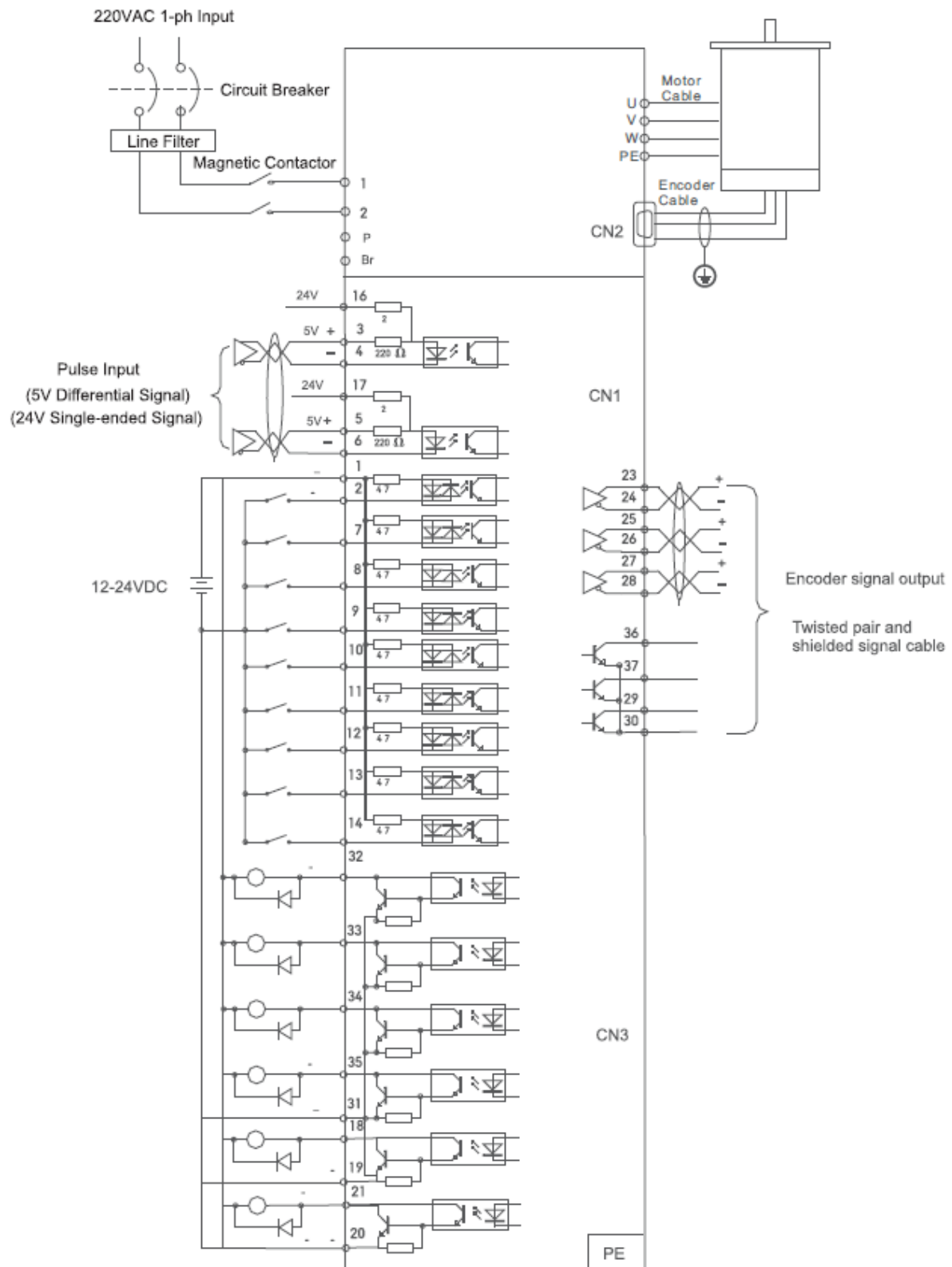

Figure 4-1 Positional Control Mode Wiring

Note: When the output power of drive you selected is higher than 1.5kw, we recommended using 3-phase power supply.

4.1.3 Torque /Velocity Control Mode

Notice: Analog input for Torque/Velocity mode is only available for ELP-RS***Z version

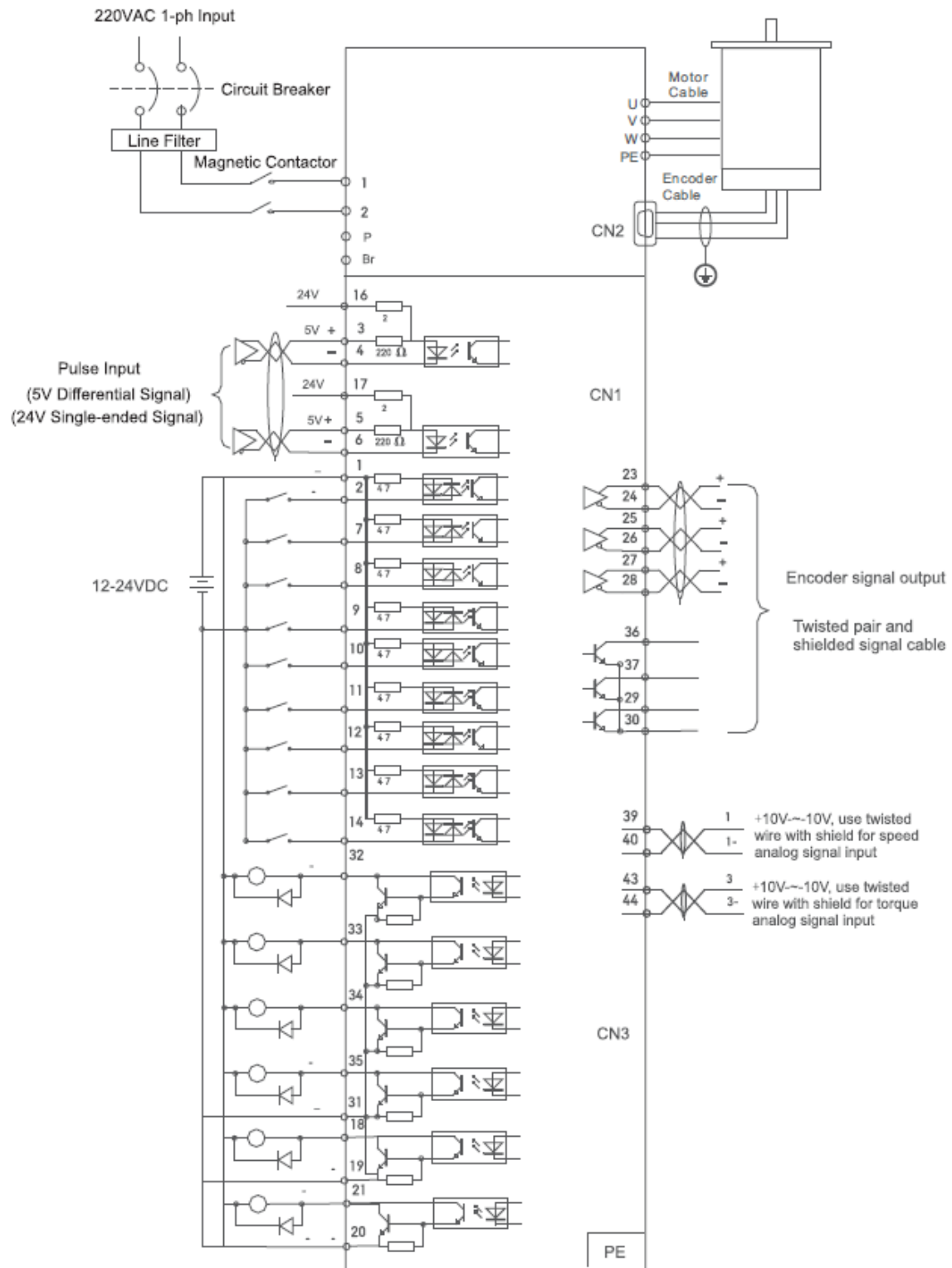

Figure 4-2 Torque/Velocity Control Mode Wiring

Note: When the output power of drive you selected is higher than 1.5kw, we recommended using 3-phase power supply.

4.2 Drive Port Function

Table 4.3 Drive Port Function

Port	Function
CN1	Control Signal Port
CN2	Encoder Input Port
CN3	USB Communication Port
CN4	RS232/ RS485 Communication Port (Only for ELP-RS***Z version)
CN5	RS232/ RS485 Communication Port (Only for ELP-RS***Z version)
X1	Power Port

4.2.1 Control Signal Port-CN1

Table 4.4 Signal Explanation of Control Signal Port-CN1

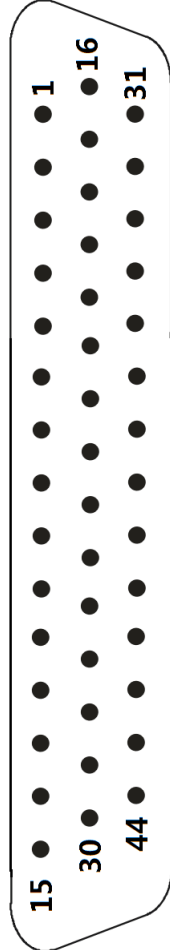
Port	Graphic	Pin	Signal	I/O	Name	Explanation	
CN1		1	COM_SI	Input	Digital input common terminal, Com+/Com-, 12VDC~24VDC	Two-way digital input with common terminal	
		2	SI1	Input	Digital input 1		
		7	SI2	Input	Digital input 2		
		8	SI3	Input	Digital input 3		
		9	SI4	Input	Digital input 4		Configurable function
		10	SI5	Input	Digital input 5		
		11	SI6	Input	Digital input 6		Recommended voltage: 12V ~ 24VDC
		12	SI7	Input	Digital input 7		
		13	SI8	Input	Digital input 8		
		14	SI9	Input	Digital input 9		
		31	COM_SO	Output	Digital output common-terminal	Max voltage/current: 30V/50mA	
		33	SO1 +	Output	Digital output 1		
		32	SO2 +	Output	Digital output 2		
		34	SO3 +	Output	Digital output 3		
		35	SO4 +	Output	Digital output 4	Recommended voltage/current: 12V ~ 24VDC/ 10mA	
		18	SO5 +	Output	Differential Digital output	5	Max voltage/current: 30V/50mA
		19	SO5 -	Output			
		20	SO6 -	Output			
		21	SO6 +	Output	Differential Digital output	6	Recommended voltage/ current: 12V ~ 24VDC/ 10mA
		23	A +	Output	Differential output terminal of motor encoder phase A		differential output High voltage ≥ 2.5VDC Low voltage ≤ 0.5VDC
		24	A -	Output			
		25	B +	Output	Differential output		Max current = ±20mA

	26	B -	Output	terminal of motor encoder phase B	Only for NPN output
	27	Z +	Output	Differential output terminal of motor encoder phase Z	
	28	Z -	Output		
	36	OCA	Output	OC output terminal of motor encoder phase A	
	37	OCB	Output	OC output terminal of motor encoder phase B	
	29	OCZ	Output	OC output terminal of motor encoder phase Z	
	30	GND	Output	OC output GND terminal of motor encoder	
	3	PUL +	Input	Pulse input under position control mode PUL+ and PUL-: 5V differential input PUL+_24 and PUL-: 24V differential input	
	4	PUL -	Input		
	16	PUL +_24	Input		
	5	DIR +	Input	Direction input under position control mode DIR+ and DIR-: 5V differential input DIR+_24 and DIR-: 24V differential input	
	6	DIR -	Input		
	17	DIR +_24	Input		
	39	AI1+	Input	Differential analog input 1 Input voltage: -10VDC ~ +10VDC, input resistor: 20KΩ Mainly for velocity mode (Analog input)	
	40	AI1-	Input		
	41	AGND	Input		
	43	AI3 +	Input	Analog input 3, voltage input range: -10VDC~+10VDC, input resistor 20KΩ. for torque mode (Analog input)	
	44	AI3 -	Input		
	15.22.38.40.42	NC	/	Not connect	
	Shell	FG	/	Shield ground	

4.2.2 Encoder Input Port-CN2

Table 4.5 Signal Explanation of Encoder Input Port-CN2

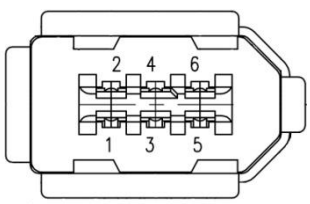
Port	Graphic	Pin	Signal	Definition
CN2		1	VCC5V	Encoder power 5V
		2	GND	Encoder power GND
		3	BAT+	External battery +
		4	BAT-	External battery -
		5	SD+	Series of encoders data +
		6	SD-	Series of encoders data -
			PE	Shield ground

4.2.3 RS232/ RS485 Communication Port-CN4/ CN5

Table 4.6 Signal Explanation of RS232/ RS485 Communication Port-CN4/ CN5

Port	Graphic	Pin	Signal	Definition
CN4		1, 9	RDO+(RS485)	RS485 data +
CN5		2, 10	RDO-(RS485)	RS485 data -

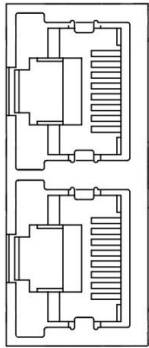
	3, 11	/	/
	4, 12	TXD(RS232)	RS232 sending end (reserved)
	5, 13	RXD(RS232)	RS232 receiving end (reserved)
	6, 14	VCC5V(RS232)	Power 5V + (reserved)
	7, 15	GND(RS232)	Power 5V GND (reserved)
	8, 16	/	/
		PE	Shield ground

4.2.4 USB Communication Port-CN3

Table 4.7 Signal Explanation of USB Communication Port-CN3

Port	Graphic	Pin	Signal	Definition
CN3		1	VCC5V	Power 5V +
		2	D+	USB data +
		3	D-	USB data -
		4	/	/
		5	GND	Power 5V GND
			USB_GND	Shield ground

4.2.5 Power Port-X1

Table 4.8 Main Power Input Port-X1

Port	Pin	Definition	Detail
X1	L1	Power phase L1	For single phase 220V , +15 ~ -15% , 50/60Hz
	L2	Power phase L2	
Notes	(1) Isolation transformer can be used for power supply; (2) Do Not access the 380VAC power supply, or it will cause serious damage to the drive; (3) In the case of serious interference, it is recommended to use Noise filter for power supply; (4) It is recommended to install a Non-fusible circuit breaker to cut off external power supply in time when the drive fails.		
Port	Pin	Definition	Detail
X1	P +	DC bus + terminal	(1) Drive Dc bus + terminal (2) External regenerative resistor P terminal
	Br	External regenerative resistor terminal	External regenerative resistor terminal
Notes	When using external resistors, the values of resistance and power are selected as follows :		
Port	Pin	Definition	Detail
X1	U	U	3 phase motor power input
	V	V	
	W	W	
	PE	PE	Frame ground

Notes ① Connect the drive to the ground end (PE) of the motor and connect it to the earth

4.3 I/O Interface Principles

4.3.1 Switch Input Interface

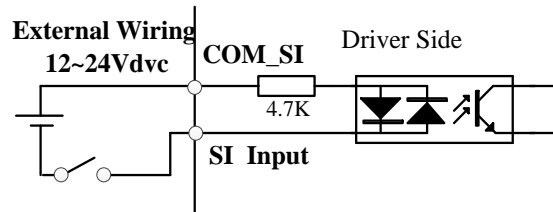

Figure 4-3 Switch Input Interface

1. The user provides power supply, DC 12-24V, current $\geq 100\text{mA}$.
2. **Notice:** if current polar connect reversely, servo drive doesn't run.

Pr4.00 *	Name	Input selection SI1			Mode	P	S	T
	Range	0~00FFFFFFh	Unit	—	Default	303		
	Data Type	16bit	Access	R/W	Address	0401H		
	Repower	o						
Pr4.01 *	Name	Input selection SI2			Mode	P	S	T
	Range	0~00FFFFFFh	Unit	—	Default	0		
	Data Type	16bit	Access	R/W	Address	0403H		
	Repower	o						
Pr4.02 *	Name	Input selection SI3			Mode	P	S	T
	Range	0~00FFFFFFh	Unit	—	Default	0		
	Data Type	16bit	Access	R/W	Address	0405H		
	Repower	o						
Pr4.03 *	Name	Input selection SI4			Mode	P	S	T
	Range	0~00FFFFFFh	Unit	—	Default	0		
	Data Type	16bit	Access	R/W	Address	0207H		
	Repower	o						
Pr4.04 *	Name	Input selection SI5			Mode	P	S	T
	Range	0~00FFFFFFh	Unit	—	Default	0		
	Data Type	16bit	Access	R/W	Address	0409H		
	Repower	o						
Pr4.05 *	Name	Input selection SI6			Mode	P	S	T
	Range	0~00FFFFFFh	Unit	—	Default	0		

	Data Type	16bit	Access	R/W	Address	040BH
	Repower	o				
Pr4.06 *	Name	Input selection SI7			Mode	P S T
	Range	0~00FFFFFFh	Unit	—	Default	0
	Data Type	16bit	Access	R/W	Address	040DH
	Repower	o				
Pr4.07 *	Name	Input selection SI8			Mode	P S T
	Range	0~00FFFFFFh	Unit	—	Default	0
	Data Type	16bit	Access	R/W	Address	040FH
	Repower	o				
Pr4.08 *	Name	Input selection SI9			Mode	P S T
	Range	0~00FFFFFFh	Unit	—	Default	0
	Data Type	16bit	Access	R/W	Address	0411H
	Repower	o				

Set SI input function allocation.

This parameter use 16 binary system to set up the values,

For the function number, please refer to the following Figure.

Signal Name	Symbol	Setup Value	
		Normally Open	Normally Closed
Invalid	-	00h	Do Not setup
Positive Direction Over-Travel Inhibition	POT	01h	81h
Negative Direction Over-Travel Inhibition	NOT	02h	82h
Servo-ON Input	SRV-ON	03h	83h
Alarm Clear Input	A-CLR	04h	Do Not setup
Control Mode Switching Input	C-MODE	05h	85h
Gain Switching Input	GAIN	06h	86h
Deviation Counter Clear Input	CL	07h	Do Not setup
Command Pulse Inhibition Input	INH	08h	88h
Electronic Gear Switching Input 1	DIV1	0Ch	8Ch
Electronic Gear Switching Input 2	DIV2	0Dh	8Dh
Selection 1 Input Of Internal Command Speed	INTSPD1	0Eh	8Eh
Selection 2 Input Of Internal Command Speed	INTSPD2	0Fh	8Fh
Selection 3 Input Of Internal Command Speed	INTSPD3	10h	90h
Speed Zero Clamp Input	ZEROSPD	11h	91h
Speed Command Sign Input	VC-SIGN	12h	92h
Torque Command Sign Input	TC-SIGN	13h	93h
Forced Alarm Input	E-STOP	14h	94h

Note:

- Normally open means input signal comes from external controller or component, for example: PLC.
- Normally closed means input signal comes from drive internally.
- Don't setup to a value other than that specified in the table.

- Don't assign specific function to 2 or more signals. Duplicated assignment will cause Err21.0 I/F input multiple assignment error 1 or Err21.1 I/F input multiple assignment error 2

PR-Mode related input setup as below:

Input			
Signal Name	Symbol	Setup Value	
		Normally Open	Normally Closed
Trigger Command	CTRG	20h	A0h
Homing Signal	HOME	21h	A1h
Forced Stop	STP	22h	A2h
Forward Direction Jog	JOG+	23h	A3h
Opposite Direction Jog	JOG-	24h	A4h
Positive Limit Switch	PL	25h	A5h
Negative Limit Switch	NL	26h	A6h
Homing Signal	ORG	27h	A7h
Road Strength Address 0	ADD0	28h	A8h
Road Strength Address 1	ADD1	29h	A9h
Road Strength Address 2	ADD2	2ah	Aah
Road Strength Address 3	ADD3	2bh	Abh
Torque Switching	TC-SEL	09h	89h

Note:

CTRG, HOME is edge triggered, but the valid level must be last more than 1ms.

I/O input digital filtering

Pr5.15 *	Name	I/F reading filter			Mode	P	S	T
	Range	0~255	Unit	0.1ms	Default	0		
	Data Type	16bit	Access	R/W	Address	051FH		
	Repower	o						

I/O input digital filtering; higher setup will initiate control delay.

4.3.2 Switch Output Interface

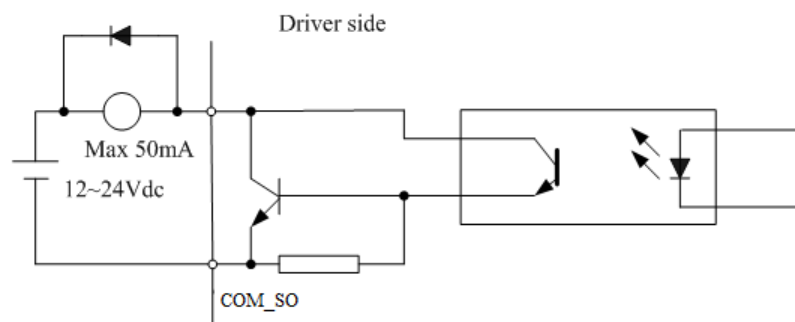

Figure 4.4 Switch Output Interface

- (1) The user provides the external power supply. However, if current polarity connects reversely, servo drive is damaged.
- (2) The output of the form is open-collector, the maximum voltage is 25V, and maximum current is 50mA. Therefore, the load of switch output signal must match the requirements. If you exceed the requirements or output directly connected with the power supply, the servo drive is damaged.

- (3) If the load is inductive loads relays, etc., there must be anti-parallel freewheeling diode across the load. If the freewheeling diode is connected reversely, the servo drive is damaged.
- (4) 32/33/34/35/31 Pin: Single-ended output;
18/19 Pin, 20/21 Pin: Differential output.

Pr4.10 *	Name	Output selection SO1			Mode	P	S	T
	Range	0~00FFFFFFh	Unit	—	Default	101		
	Data Type	16bit	Access	R/W	Address	0415H		
	Repower	o						
Pr4.11 *	Name	Output selection SO2			Mode	P	S	T
	Range	0~00FFFFFFh	Unit	—	Default	202		
	Data Type	16bit	Access	R/W	Address	0417H		
	Repower	o						
Pr4.12 *	Name	Output selection SO3			Mode	P	S	T
	Range	0~00FFFFFFh	Unit	—	Default	404		
	Data Type	16bit	Access	R/W	Address	0419H		
	Repower	o						
Pr4.13 *	Name	Output selection SO4			Mode	P	S	T
	Range	0~00FFFFFFh	Unit	—	Default	303		
	Data Type	16bit	Access	R/W	Address	041BH		
	Repower	o						
Pr4.14 *	Name	Output selection SO5			Mode	P	S	T
	Range	0~00FFFFFFh	Unit	—	Default	101		
	Data Type	16bit	Access	R/W	Address	041DH		
	Repower	o						
Pr4.15 *	Name	Output selection SO6			Mode	P	S	T
	Range	0~00FFFFFFh	Unit	—	Default	303		
	Data Type	16bit	Access	R/W	Address	041FH		
	Repower	o						

Assign functions to SO outputs.

This parameter use 16 binary system do setup

For the function number, please refer to the following Figure.

Signal Name	Symbol	Setup Value
Invalid	-	00h
Alarm Output	Alm	01h
Servo-Ready Output	S-RDY	02h
Eternal Brake Release Signal	BRK-OFF	03h
Positioning Complete Output	INP	04h
At-Speed Output	AT-SPPED	05h
Zero-Speed Detection Output	ZSP	07h

Velocity Coincidence Output	V-COIN	08h
Positional Command ON/OFF Output	P-CMD	0Bh
Speed Command ON/OFF Output	V-CMD	0Fh

PR-Mode related output setup as below;

Output			
Signal Name	Symbol	Set Value	
		Normally Open	Normally Closed
Command Complete	CMD-OK	20h	A0h
Road Strength Address	MC-OK	21h	A1h
Homing Finish	HOME-OK	22h	A2h
Torque Limit	TQL	06h	86h

Note:

CMD-OK indicates PR command sent complete, but the motor may Not in-position.

MC-OK indicates command complete and the motor in-position.

*1 Pay attention to the front panel display is hexadecimal.

4.3.3 Pulse Input Interface

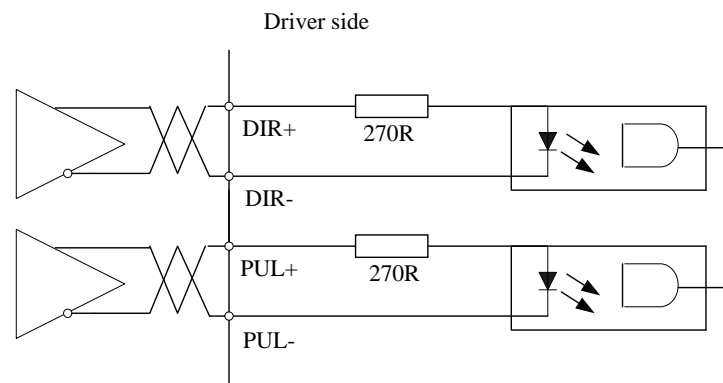
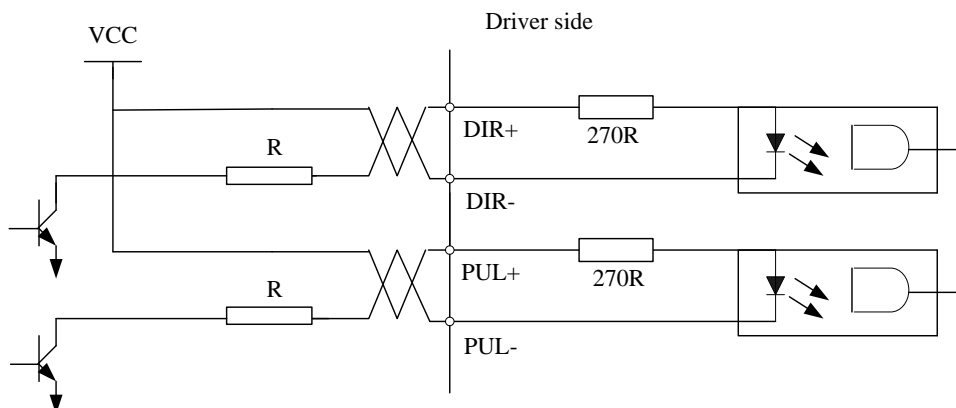

Figure 4-6 Differential 5V Pulse Signal (Pin3/Pin4/Pin5/Pin6 of CN1 Terminal)



$V_{cc} = 12V, R = 1K, 0.25W$; $V_{cc} = 24V, R = 2K, 0.25W$

Figure 4-5 Pulse Input Interface Single Terminal Drive Mode

- (1) In order to transmit pulse data properly, we recommend using the differential drive mode.
- (2) The differential drive mode, AM26LS31, MC3487 or similar RS422 line drive.

- (3) Using of single-ended drive will cause reduction of the operation frequency. The value of the resistance R depends on pulse input circuit and the external voltage, while drive current should be at the range of 10 - 15mA and the maximum voltage is No. more than 25V.

Recommendation:

VCC = 24V, R = 1.3 to 2KΩ;

VCC = 12V, R = 510 ~ 820Ω;

VCC = 5V, R = 82 ~ 120Ω.

- (4) The users provide external power supply for single-ended pulse signal. However, the wrong connection of pulse polarity will cause servo drive damaged.

(5) The form of pulse input is the following form 4.9 below, while the arrow indicates the count.

Table 4.9 Pulse Input Form

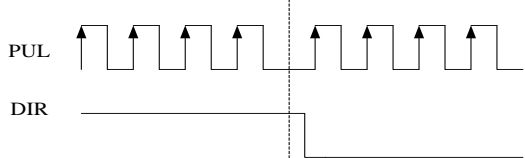
Pulse Command Form	CCW	CW	Parameter Setting Value
Pulse Symbol			Pulse + direction

The form of pulse input timing parameter is the following form 4.10 below. The 4 times pulse frequency \leq 500kHz if 2-phase input form is used.

Table 4.10 Parameters of Pulse Input Time Sequence

Parameter	Differential Drive Input	Single-Ended Drive Input
t_{ck}	$> 2\mu s$	$> 5\mu s$
t_h	$> 1\mu s$	$> 2.5\mu s$
t_l	$> 1\mu s$	$> 2.5\mu s$
t_{rh}	$< 0.2\mu s$	$< 0.3\mu s$
t_{rl}	$< 0.2\mu s$	$< 0.3\mu s$
t_s	$> 1\mu s$	$> 2.5\mu s$
t_{qck}	$> 8\mu s$	$> 10\mu s$
t_{qh}	$> 4\mu s$	$> 5\mu s$
t_{ql}	$> 4\mu s$	$> 5\mu s$
t_{qrh}	$< 0.2\mu s$	$< 0.3\mu s$
t_{qrl}	$< 0.2\mu s$	$< 0.3\mu s$
t_{qs}	$> 1\mu s$	$> 2.5\mu s$

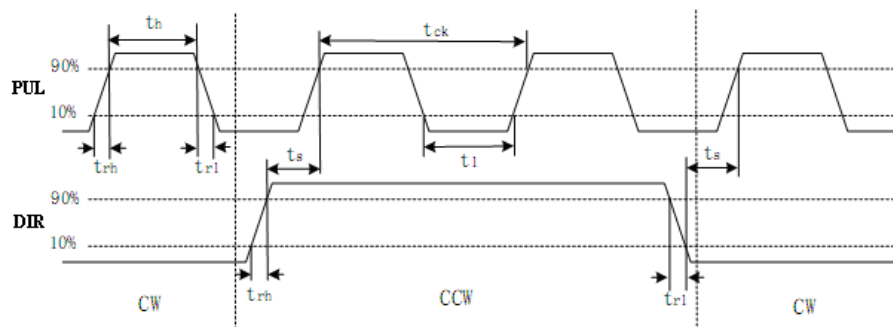

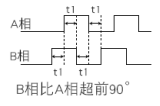
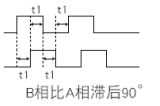
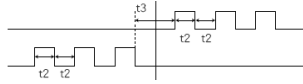
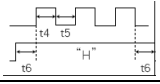
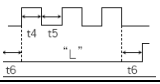
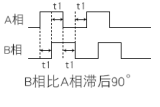

Figure 4.6 Pulse + Direction Input Interface Timing (The Maximum of Pulse Frequency: 500KHZ)

Pr0.06*	Name	Command Pulse Rotational Direction Setup	Mode	P		
----------------	------	--	------	----------	--	--

	Range	0~1	Unit	—	Default	0
	Data Type	16bit	Access	R/W	Address	000DH
	Repower	o				

Set command pulse input rotate direction, command pulse input type

Pr0.07*	Name	Command Pulse Input Mode Setup			Mode	P
	Range	0~3	Unit	—	Default	1
	Data Type	16bit	Access	R/W	Address	000FH
	Repower	o				

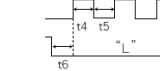
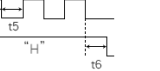
Pr0.06	Pr0.07	Command Pulse Format	Signal	Positive Direction Command	Negative Direction Command
0	0 or 2	90 phase difference 2-phase pulse(phase A +phase B)	Pulse sign		
	1	Positive direction pulse + negative direction pulse	Pulse sign		
	3	Pulse + sign	Pulse sign		
1	0 or 2	90 phase difference 2 phase pulse(phase A +phase B)	Pulse sign		
	1	Positive direction pulse + negative direction pulse	Pulse sign		
	3	Pulse + sign	Pulse sign		

Command pulse input signal allow largest frequency and smallest time width

PULS/SIGN Signal Input I/F		Permissible Max. Input Frequency	Smallest Time Width					
			t1	t2	t3	t4	t5	t6
Pulse series interface	Long distance interface	500kpps	2	1	1	1	1	1
	Open-collector output	200kpps	5	2.5	2.5	2.5	2.5	2.5

4.3.4 Analog Value Input Interface

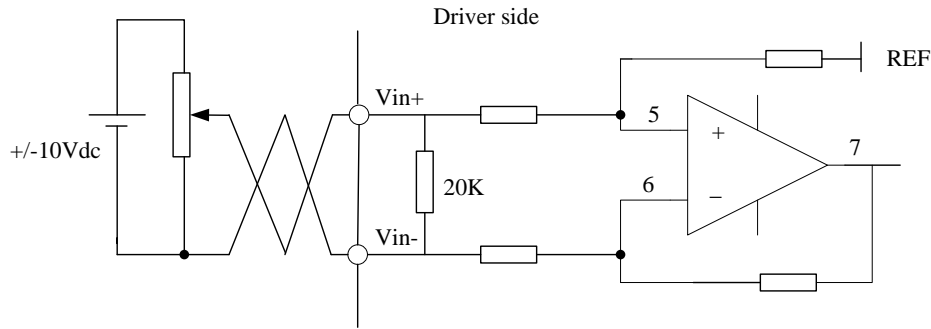
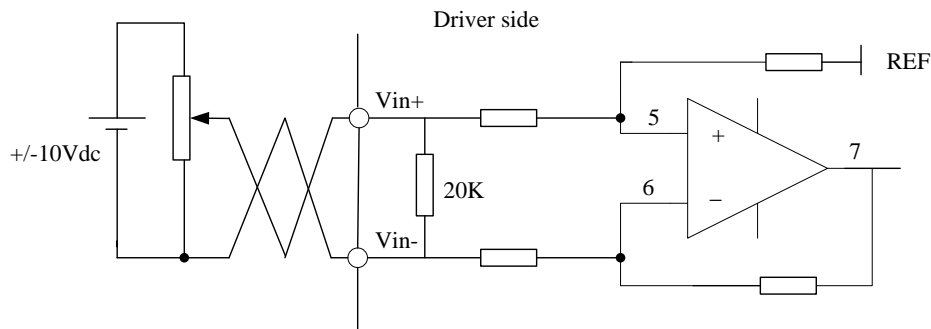
Figure 4-7 Analog AI1 Input Interface

Figure 4-8 Analog AI3 Input Interface

4.4 Battery Installation

➤ First Installation of the Battery

After installing and connecting the back-up battery to the motor, and executing an absolute multi-turn encoder setup, it is recommended to perform ON/OFF action once a day after installing the battery for refreshing the battery.

A battery error might occur due to voltage delay of the battery if you fail you to carry out battery refreshment.

➤ Replacement of the Battery

It is necessary to replace the battery for absolute multi-turn encoder when battery alarm occurs. Replace while turning on the control power, data stored in the encoder might be lost when you replace the battery the control power of drive is off.

After replacing the battery, clear the battery alarm.

➤ How to Replace the Battery

- (1) Refresh the new battery, pull out connector.



Pull out after 5min connection

(2) Take off the cover of the battery box.

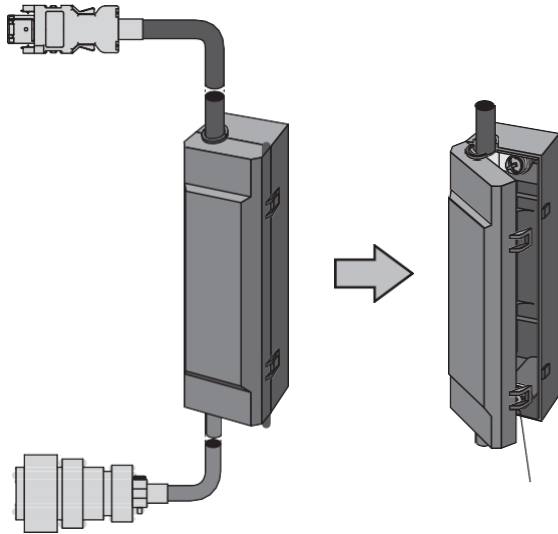

(3) Install the battery to the battery box.

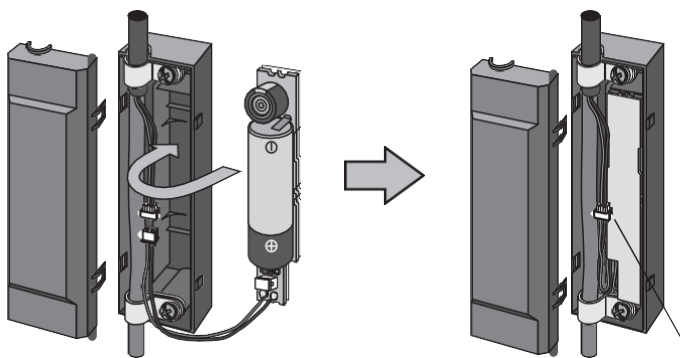

(4) Close the cover of the battery box.

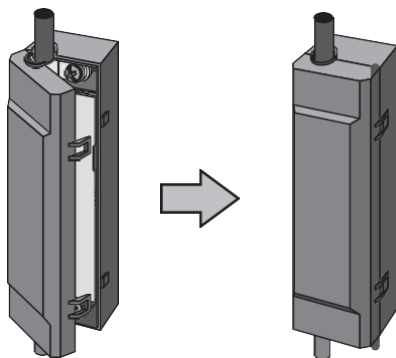

➤ **Life of the Battery**

Following the example shows the life calculation of the back-up battery.

Item	Working situation 1	Working situation 2
Working days (days)	313	52
T1 (h)	8	0
T2 (h)	0.1	0
T3 (h)	15.9	24

- **Working days in working situation 1:** Monday to Saturday in every week.
- **Working days in working situation 2:** Sunday in every week.
- **T1: time of normal working.**
- **T2: time of motor running while power off.**
- **T3: time of motor stopping while power off.**
- **Annual consumption capacity =**
 $(8h*2uA+0.1h*80uA+15.9h*10uA)*313days+(0h*2uA+0h*80uA+24h*10uA) = 70mAh$
- **Battery life = battery capacity / annual consumption capacity = 2600mAh / 70mAh = 37.1years**

4.5 Anti-Interference Solution

➤ **Circuit breaker**

The short-circuit protection circuit on the product is not for protection or branch circuit, the branch circuit should be protected in accordance with NEC and the applicable local regulations in your area.

➤ **Noise filter**

- Select a noise filter whose capacity is commensurate with the power source capacity (in consideration of load condition).
- For the detailed specifications of each noise filter, contact the manufacture.
- When two or more servo drives are used with a single noise filter at the common power source, consult with the noise filter manufacture.
- Do not run the input and output wiring on the same passage: noise resistance will drop.
- Isolate the input and output line from each other.

➤ **Surge absorber**

When performing withstand voltage test of machine and equipment, be sure to remove the surge absorber, otherwise it will be damaged.

➤ **Grounding**

- To prevent electric shock, be sure to connect the ground terminal of the drive, and the ground terminal (PE) of the control panel.
- The ground terminal must not be shared with other equipment. Two ground terminals are provided.

Chapter 5 Parameter

5.1 Parameter List

- A parameter is designated as follows:

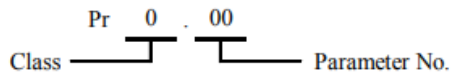

- Definition of symbols under “Mode” – P: position control, S: velocity control, T: torque control, PR: PR control.
- 32bit data, high data before, low data after.

Parameter Number		Name	Default value	Effective	Mode			Communication		
Classify	NO.				P	V	T	Data length	Access	Modbus Address
【Class 0】 Basic Setting	00	MFC Function	1	Immediate	√	—	—	16bit	R/W	0x0001
	01	Control mode setup	0	Power-on again	√	√	√	16bit	R/W	0x0003
	02	Real-time auto-gain tuning	2	Immediate	√	√	√	16bit	R/W	0x0005
	03	Selection of machine stiffness at real-time auto-gain tuning	70	Immediate	√	√	√	16bit	R/W	0x0007
	04	Inertia ratio	250	Immediate	√	√	√	16bit	R/W	0x0009
	06	Command pulse rotational direction setup	0	Power-on again	√	—	—	16bit	R/W	0x000D
	07	Command pulse input mode setup	3	Power-on again	√	—	—	16bit	R/W	0x000F
	08	Command pulse per one motor revolution	10000	Power-on again	√	—	—	32bit	R/W	0x0010 0x0011
	09	1st numerator of electronic gear	1	Power-on again	√	—	—	32bit	R/W	0x0012 0x0013
	10	Denominator of electronic gear	1	Power-on again	√	—	—	32bit	R/W	0x0014 0x0015
	11	Output pulse counts per one motor revolution	2500	Power-on again	√	√	√	16bit	R/W	0x0017
	12	Reversal of pulse output logic	0	Power-on again	√	√	√	16bit	R/W	0x0019
	13	1st Torque Limit	300	Immediate	√	√	√	16bit	R/W	0x001B
	14	Position deviation excess setup	200	Immediate	√	—	—	16bit	R/W	0x001D

15	Absolute encoder setup	0	Immediate	√	√	√	16bit	R/W	0x001F
16	External regenerative discharge resistor setup	100	Immediate	√	√	√	16bit	R/W	0x0021
17	External regenerative discharge power value	50	Immediate	√	√	√	16bit	R/W	0x0023
22	PR and P/V/T control mode switching	0	Immediate	√	√	√	16bit	R/W	0x002D
25	Auxiliary Function	0	Immediate	√	√	√	16bit	R/W	0x0033
26	Virtual IO	/	Immediate	√	√	√	16bit	R/W	0x0035
40	Mapping parameter 1	0x0	Immediate	√	√	√	32bit	R/W*	0x0050 0x0051
41	Mapping parameter 2	0x0	Immediate	√	√	√	32bit	R/W*	0x0052 0x0053
42	Mapping parameter 3	0x0	Immediate	√	√	√	32bit	R/W*	0x0054 0x0055
43	Mapping parameter 4	0x0	Immediate	√	√	√	32bit	R/W*	0x0056 0x0057
44	Mapping parameter 5	0x0	Immediate	√	√	√	32bit	R/W*	0x0058 0x0059
45	Mapping parameter 6	0x0	Immediate	√	√	√	32bit	R/W*	0x005A 0x005b
46	Mapping parameter 7	0x0	Immediate	√	√	√	32bit	R/W*	0x005C 0x005d
47	Mapping parameter 8	0x0	Immediate	√	√	√	32bit	R/W*	0x005E 0x005F
50	Mapping parameter 1 pointer	0x00490049	Immediate	√	√	√	32bit	R/W	0x0064 0x0065
51	Mapping parameter 2 pointer	0x00490049	Immediate	√	√	√	32bit	R/W	0x0066 0x0067
52	Mapping parameter 3 pointer	0x00490049	Immediate	√	√	√	32bit	R/W	0x0068 0x0069
53	Mapping parameter 4 pointer	0x00490049	Immediate	√	√	√	32bit	R/W	0x006A 0x006B
54	Mapping parameter 5 pointer	0x00490049	Immediate	√	√	√	32bit	R/W	0x006C 0x006D
55	Mapping parameter 6 pointer	0x00490049	Immediate	√	√	√	32bit	R/W	0x006E 0x007F
56	Mapping parameter 7 pointer	0x00490049	Immediate	√	√	√	32bit	R/W	0x0070 0x0071
57	Mapping parameter 8 pointer	0x00490049	Immediate	√	√	√	32bit	R/W	0x0072 0x0073

Parameter Number	Name	Default value	Effective	Mode	Communication
------------------	------	---------------	-----------	------	---------------

Classify	NO.	Name	Default value	Effective	Mode			Communication		
					P	V	T	Data length	Access	Modbus Address
【Class 1】 Gain Adjust	00	1st gain of position loop	320	Immediate	√	—	—	16bit	R/W	0x0101
	01	1st gain of velocity loop	180	Immediate	√	√	√	16bit	R/W	0x0103
	02	1st time constant of velocity loop integration	310	Immediate	√	√	√	16bit	R/W	0x0105
	03	1st filter of velocity detection	15	Immediate	√	√	√	16bit	R/W	0x0107
	04	1st time constant of torque filter	126	Immediate	√	√	√	16bit	R/W	0x0109
	05	2nd gain of position loop	380	Immediate	√	—	—	16bit	R/W	0x010B
	06	2nd gain of velocity loop	180	Immediate	√	√	√	16bit	R/W	0x010D
	07	2nd time constant of velocity loop integration	10000	Immediate	√	√	√	16bit	R/W	0x010F
	08	2nd filter of velocity detection	15	Immediate	√	√	√	16bit	R/W	0x0111
	09	2nd time constant of torque filter	126	Immediate	√	√	√	16bit	R/W	0x0113
	10	Velocity feed forward gain	300	Immediate	√	—	—	16bit	R/W	0x0115
	11	Velocity feed forward filter	50	Immediate	√	—	—	16bit	R/W	0x0117
	12	Torque feed forward gain	0	Immediate	√	√	—	16bit	R/W	0x0119
	13	Torque feed forward filter	0	Immediate	√	√	—	16bit	R/W	0x011B
	15	Control switching mode	0	Immediate	√	—	—	16bit	R/W	0x011F
	17	Control switching level	50	Immediate	√	—	—	16bit	R/W	0x0123
	18	Control switch hysteresis	33	Immediate	√	—	—	16bit	R/W	0x0125
	19	Gain switching time	33	Immediate	√	—	—	16bit	R/W	0x0127
	35	Positional command filter setup	0	Power-on again	√	—	—	16bit	R/W	0x0147
	37	Special Register	0	Immediate	√	√	√	16bit	R/W	0x014B

Classify	NO.	Name	Default value	Effective	Mode			Communication		
					P	V	T	Data length	Access	Modbus Address
【Class 2】 Vibration Restrain Function	00	Adaptive filter mode setup	0	Immediate	√	√	—	16bit	R/W	0x0201
	01	1st notch frequency	2000	Immediate	√	√	√	16bit	R/W	0x0203
	02	1st notch width selection	2	Immediate	√	√	√	16bit	R/W	0x0205
	03	1st notch depth selection	0	Immediate	√	√	√	16bit	R/W	0x0207
	04	2nd notch frequency	2000	Immediate	√	√	√	16bit	R/W	0x0209
	05	2nd notch width selection	2	Immediate	√	√	√	16bit	R/W	0x020B
	06	2nd notch depth selection	0	Immediate	√	√	√	16bit	R/W	0x020D
	07	3rd notch frequency	2000	Immediate	√	√	√	16bit	R/W	0x020F
	08	3rd notch width selection	2	Immediate	√	√	√	16bit	R/W	0x0211
	09	3rd notch depth selection	0	Immediate	√	√	√	16bit	R/W	0x0213
	14	1st damping frequency	0	Immediate	√	—	—	16bit	R/W	0x021D

	16	2nd damping frequency	0	Immediate	√	—	—	16bit	R/W	0x0221
	22	Positional command smooth filter	0	Power-on again	√	—	—	16bit	R/W	0x022D
	23	Positional command fir filter	0	Power-on again	√	—	—	16bit	R/W	0x022F

Parameter Number		Name	Default value	Effective	Mode			Communication		
Classify	NO.				P	V	T	Data length	Access	Modbus Address
【Class 3】 Velocity, Torque Control	00	Velocity setup internal/external switching	0	Immediate	—	√	—	16bit	R/W	0x0301
	01	Speed command rotational direction selection	0	Immediate	—	√	—	16bit	R/W	0x0303
	02	Speed command input gain	500	Immediate	—	√	√	16bit	R/W	0x0305
	03	Speed command reversal input	0	Immediate	—	√	—	16bit	R/W	0x0307
	04	1st speed setup	0	Immediate	—	√	—	16bit	R/W	0x0309
	05	2nd speed setup	0	Immediate	—	√	—	16bit	R/W	0x030B
	06	3rd speed setup	0	Immediate	—	√	—	16bit	R/W	0x030D
	07	4th speed setup	0	Immediate	—	√	—	16bit	R/W	0x030F
	08	5th speed setup	0	Immediate	—	√	—	16bit	R/W	0x0311
	09	6th speed setup	0	Immediate	—	√	—	16bit	R/W	0x0313
	10	7th speed setup	0	Immediate	—	√	—	16bit	R/W	0x0315
	11	8th speed setup	0	Immediate	—	√	—	16bit	R/W	0x0317
	12	Time setup acceleration	100	Immediate	—	√	—	16bit	R/W	0x0319
	13	Time setup deceleration	100	Immediate	—	√	—	16bit	R/W	0x031B
	14	Sigmoid acceleration/deceleration time setup	0	Power-on again	—	√	—	16bit	R/W	0x031D
	15	Speed zero-clamp function selection	0	Immediate	—	√	—	16bit	R/W	0x031F
	16	Speed zero-clamp level	30	Immediate	—	√	—	16bit	R/W	0x0321
	17	Torque command selection	0	Immediate	—	—	√	16bit	R/W	0x0323
	18	Torque command direction selection	0	Immediate	—	—	√	16bit	R/W	0x0325
	19	Torque command input gain	30	Immediate	—	—	√	16bit	R/W	0x0327
	20	Torque command input reversal	0	Immediate	—	—	√	16bit	R/W	0x0329
	21	Speed limit value 1	0	Immediate	—	—	√	16bit	R/W	0x032B
	22	2nd torque limit	0	Immediate	√	√	√	16bit	R/W	0x032D
	23	Speed zero-motor standstill delay time	0	Immediate	—	√	—	16bit	R/W	0x032F
	24	Maximum speed of motor rotation	0	Immediate	√	√	√	16bit	R/W	0x0331
	28	Synchronous parameter setting of gantry	0	Immediate	√	√	√	16bit	R/W	0x0339
	29	Analog 1- clamp voltage	0	Immediate	—	—	√	16bit	R/W	0x033B
	30	Analog 3- clamp voltage	0	Immediate	—	—	√	16bit	R/W	0x033D

	62	Velocity analog (only modbus setup)	0	Immediate	—	√	√	16bit	R/W	0x037D
	63	Torque analog (only modbus setup)	0	Immediate	—	—	√	16bit	R/W	0x037F

Parameter Number		Name	Default value	Effective	Mode			Communication		
Classify	NO.				P	V	T	Data length	Access	Modbus Address
【Class 4】 I/F Monitor Setting	00	Input selection SI1	3	Power-on again	√	√	√	16bit	R/W	0x0401
	01	Input selection SI2	0	Power-on again	√	√	√	16bit	R/W	0x0403
	02	Input selection SI3	0	Power-on again	√	√	√	16bit	R/W	0x0405
	03	Input selection SI4	0	Power-on again	√	√	√	16bit	R/W	0x0407
	04	Input selection SI5	0	Power-on again	√	√	√	16bit	R/W	0x0409
	05	Input selection SI6	0	Power-on again	√	√	√	16bit	R/W	0x040B
	06	Input selection SI7	0	Power-on again	√	√	√	16bit	R/W	0x040D
	07	Input selection SI8	0	Power-on again	√	√	√	16bit	R/W	0x040F
	08	Input selection SI9	0	Power-on again	√	√	√	16bit	R/W	0x0411
	10	Output selection SO1	1	Power-on again	√	√	√	16bit	R/W	0x0415
	11	Output selection SO2	2	Power-on again	√	√	√	16bit	R/W	0x0417
	12	Output selection SO3	4	Power-on again	√	√	√	16bit	R/W	0x0419
	13	Output selection SO4	3	Power-on again	√	√	√	16bit	R/W	0x041B
	14	Output selection SO5	1	Power-on again	√	√	√	16bit	R/W	0x041D
	15	Output selection SO6	3	Power-on again	√	√	√	16bit	R/W	0x041F
	22	Analog input 1(AI 1) offset setup	0	Immediate	—	√	√	16bit	R/W	0x042D
	23	Analog input 1(AI 1) filter	0	Immediate	—	√	√	16bit	R/W	0x042F
	24	Analog input 1(AI 1) over-voltage setup	0	Immediate	—	√	√	16bit	R/W	0x0431
28	Analog input 3(AI 3) offset setup	0	Immediate	—	√	√	16bit	R/W	0x0439	

29	Analog input 3(AI 3) filter	0	Immediate	—	√	√	16bit	R/W	0x43B
30	Analog input 3(AI 3) over-voltage setup	0	Immediate	—	—	√	16bit	R/W	0x043D
31	Positioning complete range	10	Immediate	√	—	—	16bit	R/W	0x043F
32	Positioning complete output setup	0	Immediate	√	—	—	16bit	R/W	0x0441
33	INP hold time	0	Immediate	√	—	—	16bit	R/W	0x0443
34	Zero-speed	50	Immediate	√	√	√	16bit	R/W	0x0445
35	Speed coincidence range	50	Immediate		√	—	16bit	R/W	0x0447
36	At-speed	1000	Immediate		√	—	16bit	R/W	0x0449
37	Mechanical brake action at stalling setup	0	Immediate	√	√	√	16bit	R/W	0x044B
38	Mechanical brake action at running setup	0	Immediate	√	√	√	16bit	R/W	0x044D
39	Brake action at running setup	30	Immediate	√	√	√	16bit	R/W	0x044F
43	E-stop function active	0	Immediate	√	√	√	16bit	R/W	0x0457

Parameter Number		Name	Default value	Effective	Mode			Communication		
Classify	NO.				P	V	T	Data length	Access	Modbus Address
【Class 5】 Extended Setup	00	2nd numerator of electronic gear	10000	Power-on again	√	—	—	32bit	R/W	0x0500 0x0501
	01	3rd numerator of electronic gear	1	Power-on again	√	—	—	32bit	R/W	0x0502 0x0503
	02	4th numerator of electronic gear	1	Power-on again	√	—	—	32bit	R/W	0x0504 0x0505
	04	Drive inhibit input setup	0	Immediate	√	√	√	16bit	R/W	0x0509
	06	Sequence at servo-off	0	Immediate	√	√	√	16bit	R/W	0x050D
	09	Main power off detection time	70	Immediate	√	√	√	16bit	R/W	0x0513
	10	Dynamic braking mode	0	Power-on again	√	√	√	16bit	R/W	0x0515
	11	Torque setup for emergency stop	0	Immediate	√	√	√	16bit	R/W	0x0517
	12	Over-load level setup	0	Immediate	√	√	√	16bit	R/W	0x0519
	13	Over-speed level setup	0	Immediate	√	√	√	16bit	R/W	0x051B
	15	I/f reading filter	0	Power-on again	√	√	√	16bit	R/W	0x051F
	17	Counter clear up input mode	3	Immediate	√	—	—	16bit	R/W	0x0523
	20	Position setup unit select	2	Immediate	√	—	—	16bit	R/W	0x0529
	21	Selection of torque limit	0	Immediate	√	√	√	16bit	R/W	0x052B
	22	2nd torque limit	300	Immediate	√	√	√	16bit	R/W	0x052D
	23	Torque limit switching setup 1	0	Immediate	√	√	√	16bit	R/W	0x052F
24	Torque limit switching setup 2	0	Immediate	√	√	√	16bit	R/W	0x0531	

	28	Led initial status	1	Immediate	√	√	√	16bit	R/W	0x0539
	29	Modbus mode selection	21	Immediate	√	√	√	16bit	R/W	0x053B
	30	Modbus baud rate setup	2	Immediate	√	√	√	16bit	R/W	0x053D
	31	Modbus slave axis address	1	Immediate	√	√	√	16bit	R/W	0x053F
	32	Command pulse input maximum setup	0	Immediate	√	—	—	16bit	R/W	0x0541
	35	Front panel lock setup	0	Immediate	√	√	√	16bit	R/W	0x0547
	36	Password for opening group 7 parameter	0	Immediate	√	√	√	16bit	R/W	0x0549

Parameter Number		Name	Default value	Effective	Mode			Communication		
Classify	NO.				P	V	T	Data length	Access	Modbus Address
【Class 6】 Special Setup	01	Encoder zero position compensation	0	Power-on again	√	√	√	16bit	R/W	0x0603
	03	Jog trial run command torque	0	Immediate	√	—	—	16bit	R/W	0x0607
	04	Jog trial run command speed	400	Immediate	√	—	—	16bit	R/W	0x0609
	05	Position 3rd Gain Valid Time	0	Immediate	√	—	—	16bit	R/W	0x060B
	06	Position 3rd Gain Scale Factor	100	Immediate	√	—	—	16bit	R/W	0x060D
	07	Torque command additional value	0	Immediate	√	√	√	16bit	R/W	0x060F
	08	Positive direction torque compensation value	0	Immediate	√	√	√	16bit	R/W	0x0611
	09	Negative direction torque compensation value	0	Immediate	√	√	√	16bit	R/W	0x0613
	10	Function extension	0x0	Power-on again	√	—	—	16bit	R/W	0x0615
	11	Current response setup	100	Immediate	√	√	√	16bit	R/W	0x0617
	14	Emergency stop time at alarm	0	Immediate	√	√	√	16bit	R/W	0x061D
	20	Distance of trial running	10	Immediate	√	—	—	16bit	R/W	0x0629
	21	Waiting time of trial running	100	Immediate	√	—	—	16bit	R/W	0x062B
	22	Cycling times of trial running	5	Immediate	√	—	—	16bit	R/W	0x062D
	25	Acceleration of trial running	200	Immediate	√	—	—	16bit	R/W	0x0633
	27	Warning lock-up time	0	Immediate	√	√	—	16bit	R/W	0x0637
	28	Observer gain	0	Immediate	√	√	√	16bit	R/W	0x0639
	29	Observer filter	0	Immediate	√	√	√	16bit	R/W	0x063B
	56	Torque threshold of motor blocking alarm	300	Immediate	√	√	√	16bit	R/W	0x0661
	57	Motor blocking alarm delay time	0	Immediate	√	√	√	16bit	R/W	0x0663
63	Absolute multi-turn position upper bound	0	Power-on again	√	√	√	16bit	R/W	0x067F	

Parameter Number		Name	Default value	Effective	Mode			Communication		
Classify	NO.				P	V	T	Data length	Access	Modbus Address
【Class B】 Status Information	00	Software version 1 (DSP)		Immediate	√	√	√	16bit	R	0x0B00
	01	Software version 2 (CPLD)		Immediate	√	√	√	16bit	R	0x0B01
	02	Software version 3 (other)		Immediate	√	√	√	16bit	R	0x0B02
	03	Error code		Immediate	√	√	√	16bit	R	0x0B03
	04	Factor of No.-motor running		Immediate	√	√	√	16bit	R	0x0B04
	05	Drive operating state		Immediate	√	√	√	16bit	R	0x0B05
	06	Actual velocity (unfiltered)		Immediate	√	√	√	16bit	R	0x0B06
	07	Actual torque feedback		Immediate	√	√	√	16bit	R	0x0B07
	08	Actual current feedback		Immediate	√	√	√	16bit	R	0x0B08
	09	Actual velocity(After filtering)		Immediate	√	√	√	16bit	R	0x0B09
	10	DC bus voltage		Immediate	√	√	√	16bit	R	0x0B0A
	11	Drive temperature		Immediate	√	√	√	16bit	R	0x0B0B
	12	Analog input1		Immediate	√	√	√	16bit	R	0x0B0C
	13	Analog input2		Immediate	√	√	√	16bit	R	0x0B0D
	14	Analog input3		Immediate	√	√	√	16bit	R	0x0B0E
	15	Over-load ratio		Immediate	√	√	√	16bit	R	0x0B0F
	16	Regeneration load ratio		Immediate	√	√	√	16bit	R	0x0B10
	17	Digital input signal status		Immediate	√	√	√	16bit	R	0x0B11
	18	Digital output signal status		Immediate	√	√	√	16bit	R	0x0B12
	20	Motor position feedback (Command unit)		Immediate	√	√	√	32bit	R	0x0B14 0x0B15
	21	Command pulse sum (Command unit)		Immediate	√	-	-	32bit	R	0x0B16 0x0B17
	22	Positional deviation(Command unit)		Immediate	√	√	√	32bit	R	0x0B18 0x0B19
	23	Position command (Encoder unit)		Immediate	√	√	√	32bit	R	0x0B1A 0x0B1B
	24	Motor position (encoder unit)		Immediate	√	-	-	32bit	R	0x0B1C 0x0B1D
	25	Positional deviation (encoder unit)		Immediate	√	√	√	32bit	R	0x0B1E 0x0B1F
	26	Position feedback in rotation mode(encoder unit)		Immediate	√	-	-	32bit	R	0x0B20 0x0B21

5.2 Parameter Function

Here is the explanation of parameters, you can check them or modify the value using software Motion Studio or the front panel of servo drive.

Contact tech@leadshine.com if you need more technical service.

5.2.1 【Class 0】 Basic Setting

Pr0.00	Name	Mode loop gain			Mode	P	V	T
	Range	0-2000	Unit	0.1Hz	Default	1		
	Data length	16bit	Access	R/W	Address	0x0001		
	Effective	Immediate						

Set up the bandwidth of MFC , it is similar to the response bandwidth

Setup value	Meaning
0	Disable the function.
1	Enable the function, set the bandwidth automatically, recommended for most application.
2-10	Forbidden and reserved.
11-20000	Set the bandwidth manually , 1.1Hz – 2000Hz

MFC is used to enhance the performance of dynamic tracing for input command, make positioning faster, cut down the tracking error, and run more smooth and steady. It is very useful for multi-axis synchroNo.us movement and interpolation, the performance will be better.

The main way to use this function :

- a. Choose the right control mode : Pr0.01 = 0
- b. Set up Pr0.02=1 for interpolation movement
- c. Set up the inertia of ratio : Pr0.04
- d. Set up the rigidity : Pr0.03
- e. Set up the Pr0.00 :
 - 1) If No. multi-axis synchroNo.us movement , set Pr0.00 as 1 or more than 10 ;
 - 2) If multi-axis synchroNo.us movement needed, set Pr0.00 as the same for all the axes.
 - 3) If Pr0.00 is more than 10, start with 100, or 150, 200, 250....

Caution:

1. Set up the right control mode, the right inertia of ratio and rigidity firstly.
 2. Don't change the value of Pr0.00 when the motor is running , otherwise vibration occurs
- Set up a small value from the beginning if using it in manual mode , smaller value means running more smooth and steady , while bigger one means faster positioning

Pr0.01*	Name	Control mode setup			Mode	P	V	T
	Range	0~10	Unit	—	Default	0		
	Data length	16bit	Access	R/W	Address	0x0003		
	Effective	Power-on again						

Set using control mode:

Setup Value	Content	
	1st Mode	2nd Mode
0	Position	-
1	Velocity	-

When you set up the combination mode of 3.4.5, you can select either the 1st or the 2nd with control mode switching input(C-MODE).
When C-MODE is on, the 1st mode will

	2	Torque	-	be selected. When C-MODE is off, the 2nd mode will be selected.
	3	Position	Velocity	
	4	Position	Torque	
	5	Velocity	Torque	
	6	PR-Mode		
	7~10	Reserved		

Pr0.02	Name	Real-time auto-gain tuning			Mode	P	V	T
	Range	0~2	Unit	—	Default	0		
	Data length	16bit	Access	R/W	Address	0x0005		
	Effective	Immediate						

You can set up the action mode of the real-time auto-gain tuning:

Setup Value	Mode	Varying Degree of Load Inertia In Motion
0	invalid	Real-time auto-gain tuning function is disabled.
1	standard	Basic mode. Do Not use unbalanced load, friction compensation or gain switching. It is usually for interpolation movement.
2	positioning	Main application is positioning. it is recommended to use this mode on equipment without unbalanced horizontal axis, ball screw driving equipment with low friction, etc. it is usually for point-to point movement .

Caution: If Pr0.02=1 or 2 , you can't modify the values of Pr1.01 – Pr1.13, the values of them depend on the real-time auto-gain tuning ,all of them are set by the drive itself

For **Standard** mode (Pr0.02=1), it is usually for interpolation movement. It is unavailable to modify the value of Pr1.00- 1.14, just need to change the value of Pr0.03, and then all values of Pr1.00-1.14 will be changed accordingly.

For **Positioning** mode (Pr0.02=2), it is usually for point to point movement. It is unavailable to modify the value of Pr1.00- 1.14, just change the value of Pr0.03 ,then all values of Pr1.00-1.14 will be changed

Pr0.03	Name	Selection of machine stiffness at real- time auto-gain tuning			Mode	P	V	T
	Range	50 -81	Unit	—	Default	70		
	Data length	16bit	Access	R/W	Address	0x0007		
	Effective	Immediate						

You can set up response while the real-time auto-gain tuning is valid.

Low ———▶ Machine stiffness ———▶ High

Low ———▶ Servo gain ———▶ High

81.80.....70.69.68.....51.50

Low ———▶ Response ———▶ High

Notice: Lower the setup value, higher the velocity response and servo stiffness will be obtained. However, when decreasing the value, check the resulting operation to avoid oscillation or vibration. Control gain is updated while the motor is stopped. If the motor can't be stopped due to excessively

low gain or continuous application of one-way direction command, any change made to Pr0.03 is Not used for update. If the changed stiffness setting is made valid after the motor stopped, abnormal sound or oscillation will be generated. To prevent this problem, stop the motor after changing the stiffness setting and check that the changed setting is enabled.

Pr0.04	Name	Inertia ratio			Mode	P	V	T
	Range	0~10000	Unit	%	Default	250		
	Data length	16bit	Access	R/W	Address	0x 0009		
	Effective	Immediate						

You can set up the ratio of the load inertia against the rotor (of the motor) inertia.

$$\text{Pr0.04} = (\text{load inertia} / \text{rotor inertia}) \times 100\%$$

Notice:



If the inertia ratio is correctly set, the setup unit of Pr1.01 and Pr1.06 becomes (Hz).

When the inertia ratio of Pr0.04 is larger than the actual value, the setup unit of the velocity loop gain becomes larger, and when the inertia ratio of Pr0.04 is smaller than the actual value, the setup unit of the velocity loop gain becomes smaller.

Pr0.06*	Name	Command pulse rotational direction setup			Mode	P		
	Range	0~1	Unit	—	Default	0		
	Data length	16bit	Access	R/W	Address	0x 000D		
	Effective	Power-on again						

Set command pulse input rotate direction, command pulse input type

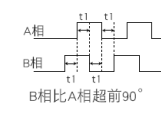
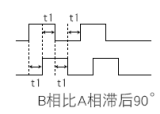
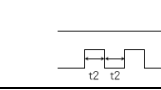
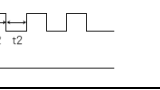
Pr0.07*	Name	Command Pulse Input Mode Setup			Mode	P		
	Range	0~3	Unit	—	Default	1		
	Data length	16bit	Access	R/W	Address	0x 000F		
	Effective	Power-on again						

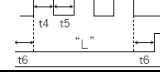
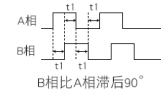
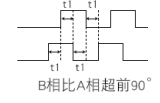
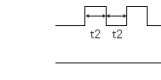
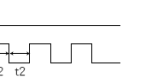
Pr0.06	Pr0.07	Command pulse format	Signal	Positive direction command	Negative direction command
0	0 or 2	90 phase difference 2-phase pulse(phase A +phase B)	Pulse sign	 <p style="font-size: small;">A相 B相 B相比A相超前90°</p>	 <p style="font-size: small;">A相 B相 B相比A相滞后90°</p>
	1	Positive direction pulse + negative direction pulse	Pulse sign		
	3	Pulse + sign	Pulse sign		
1	0 or 2	90 phase difference 2 phase pulse(phase A +phase B)	Pulse sign	 <p style="font-size: small;">A相 B相 B相比A相滞后90°</p>	 <p style="font-size: small;">A相 B相 B相比A相超前90°</p>
	1	Positive direction pulse + negative direction pulse	Pulse sign		

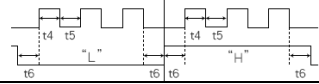
	3	Pulse + sign	Pulse sign					
Command pulse input signal allow largest frequency and smallest time width								
Puls/sign signal input I/F		Permissible max. Input frequency	Smallest time width					
Pulse series interface	Long distance interface	500kpps	t1	t2	t3	t4	t5	t6
	Open-collector output	200kpps	2	1	1	1	1	1
			5	2.5	2.5	2.5	2.5	2.5

Pr0.08	Name	Command pulse counts per one motor revolution			Mode	P	V	T
	Range	0-8388608	Unit	P	Default	0		
	Data length	32bit	Access	R/W	Address	0x 0010 0x 0011		
	Effective	Power-on again						
Set the command pulse that causes single turn of the motor shaft.								
1) If Pr008≠0 , the actual motor rotation turns = pulse number / Pr008								
2) If Pr008 = 0 , Pr0.09 1 st numerator of electronic gear and Pr0.10 denominator of electronic gear become valid.								

Pr0.09	Name	1st numerator of electronic gear			Mode	P		
	Range	1~1073741824	Unit	—	Default	1		
	Data length	32bit	Access	R/W	Address	0x 0012 0x 0013		
	Effective	Power-on again						

Set the numerator of division/multiplication operation made according to the command pulse input.

Pr0.10	Name	1st denominator of electronic gear			Mode	P		
	Range	1~1073741824	Unit	—	Default	1		
	Data length	32bit	Access	R/W	Address	0x 0014 0x 0015		
	Effective	Power-on again						

Set the denominator of division/multiplication operation made according to the command pulse input.

Pr0.09	Pr0.10	Command division/multiplication operation	
1-10737 41824	1-10737 41824	Command pulse input →	position command →
		<div style="border: 1px solid black; padding: 5px; display: inline-block;"> 【Pr0.09 set value】 【Pr0.10 set value】 </div>	

1. Settings:

- 1)The drive input command pulse number is X
- 2)The pulse number of encoder after frequency division and frequency doubling is Y
- 3)The number of pulses per revolution of the motor encoder is Z
- 4)Number of turns of motor is W

2. Calculations:







- 1) $Y=X \cdot \text{Pr0.09} / \text{Pr0.10}$
 2) 17-bit encoder: $Z=2^{17} = 131072$
 23-bit encoder: $Z=2^{23} = 8388608$

Pr0.11 *	Name	Output pulse counts per one motor revolution			Mode	P	V	T
	Range	1~2500	Unit	P/r	Default	2500		
	Data length	16bit	Access	R/W	Address	0x 0017		
	Effective	Power-on again						

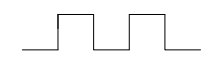
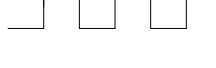
For example, if this parameter is set to 1000, it means that the frequency division output signal of the encoder outputs 4000 pulses per turn.

Pr0.12 *	Name	Reversal of pulse output logic			Mode	P	V	T
	Range	0~1	Unit	—	Default	0		
	Data length	16bit	Access	R/W	Address	0x 0019		
	Effective	Power-on again						

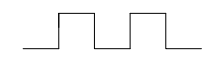
You can set up the phase B logic and the output source of the pulse output. With this parameter, you can reverse the phase relation between the phase A pulse and phase B pulse by reversing the phase B logic.
< reversal of pulse output logic >

Pr0.12	phase A Logic	CCW direction rotation	CW direction rotation
0	Standard	Phase A  Phase B 	Phase A  Phase B 
1	Reverse	phase A  Phase B 	Phase A  Phase B 

Pr0.13	Name	1st torque limit			Mode	P	V	T
	Range	0~500	Unit	%	Default	300		
	Data length	16bit	Access	R/W	Address	0x 001B		
	Effective	Immediate						

You can set up the limit value of the motor output torque, as motor rate current %, the value can't exceed the maximum of output current.

Pr0.14	Name	Position deviation excess setup			Mode	P		
	Range	0~500	Unit	0.1rev	Default	200		
	Data length	16bit	Access	R/W	Address	0x 001D		
	Effective	Immediate						

Set excess range of positional deviation by the command unit(default).Setting the value too small will cause Err18.0 (position deviation excess detection)

Pr0.15	Name	Absolute encoder setup			Mode	P	V	T
	Range	0~15	Unit		Default	0		
	Data length	16bit	Access	R/W	Address	0x 001F		
	Effective	Power-on again						

How to use:

0: Incremental position mode:

The encoder is used as a incremental encoder, and the position retentive at power failure is Not supported.

1: Absolute position linear mode:

The encoder is used as an absolute encoder, and the position retentive at power failure is supported.

It is applicable to the scenario where the travel range of device load is fixed and the encoder multi-turn data dose Not overflow.

2: Absolute position rotation mode:

The encoder is used as an absolute encoder, and the position retentive at power failure is supported.

It is mainly applicable to the scenario where the load travel range is Not limited and the number of motor single-direction revolution is less than 0~(Pr6.63+1)

5: Clean multi-turn alarm, and open multi-turn absolute function.

It will become 1 when Normal clearance, if it's still 5 after 3seconds, please deal with according to 153 alarm processing.

9: Clear multi-turn position and reset multi-turn alarm, open multi-turn absolute function.

It will become 1 when Normal clearance, if it's still 9 after 3seconds, please deal with according to 153 alarm processing. Please remember to do mechanical homing.

Notes: Set to 9 after homing process finished and servo disabled, valid after Effective.

Pr0.16	Name	External regenerative resistance			Mode	P	V	T
	Range	10~50	Unit	Ω	Default	100		
	Data length	16bit	Access	R/W	Address	0x 0021		
	Effective	Immediate						

Set Pr.0.16 and Pr.0.17 to confirm the threshold value of the discharge loop to give alarm for over current.

Pr0.17	Name	External regenerative resistor power value			Mode	P	V	T
	Range	0~10000	Unit	W	Default	20		
	Data length	16bit	Access	R/W	Address	0x 0023		
	Effective	Immediate						

Set Pr.0.16 and Pr.0.17 to confirm the threshold value of the discharge loop to give alarm for over current.

Pr0.22	Name	PR and P/S/T control mode switching			Mode	P	V	T
	Range	0~2	Unit	-	Default	0		
	Data length	16bit	Access	R/W	Address	0x002D		
	Effective	Immediate						

When you set up the Pr0.01 of 6, you can set the 2nd mode with Pr0.22.
 You can select either the 1st or the 2nd with control mode switching input(C-MODE).
 When C-MODE is on, the 1st mode (PR) will be selected.
 When C-MODE is off, the 2nd mode will be selected.

Pr0.01	Pr0.22	Control Mode
6	【0】	PR / Position Mode
	1	PR/ Velocity Mode
	2	PR/ Torque Mode

Pr0.25	Name	Auxiliary function			Mode	P	V	T
	Range	0~0xFFFF	Unit		Default	0		
	Data length	16bit	Access	R/W	Address	0x 0033		
	Effective	Immediate						
	Value	Auxiliary function						
	0x1111	Reset current alarm						
	0x1122	Reset history alarm						
	0x2211	Save parameter						
	0x2222	Reset to factory setting except motor parameters						
	0x2233	Reset to factory setting						
	0x4001	JOG_P (50ms time period)						
	0x4002	JOG_N (50ms time period)						
	0x6666	Soft reset						

Pr0.26 (Modbus)	Name	Virtual IO			Mode	P	V	T
	Range	0~0xFFFF	Unit	-	Default	0		
	Data length	16bit	Access	R/W	Address	0x0035		
	Effective	Immediate						
	Bit	Input						
	0	SI1						Note: Only for Modbus communication: Virtual IO and physical IO are exclusive OR. The current IO state will be inverted.
	1	SI2						
	2	SI3						
	3	SI4						
	4	SI5						
	5	SI6						
	6	SI7						
	7	SI8						
	8	SI9						

Pr0.40 (Modbus)	Name	Mapping parameter 1			Mode	P	V	T
	Range		Unit		Default	0		
	Data length	32bit	Access		Address	H: 0x0050		
	Effective	Immediate				L: 0x0051		

It is mainly provided to the user to quickly read and write decentralized parameter addresses.

You can set Pr0.50 to the mapping parameter which you want to read and write. When you read and write Pr0.40 data, it is equivalent to reading and writing the parameters specified by Pr0.50.

The parameter setting method is described in Pr0.57

Note:

The parameter Range, Unit, Access, etc. of Pr0.40 are determined by the parameter specified by Pr0.50.

Pr0.41 (Modbus)	Name	Mapping parameter 2			Mode	P	V	T
	Range		Unit		Default	0		
	Data length	32bit	Access		Address	H: 0x0052		
	Effective	Immediate				L: 0x0053		
The parameter description refers to Pr0.40, and the parameter setting method refers to Pr0.57. Note: The parameter Range, Unit, Access, etc. of Pr0.41 are determined by the parameter specified in Pr0.51.								

Pr0.42 (Modbus)	Name	Mapping parameter 3			Mode	P	V	T
	Range		Unit		Default	0		
	Data length	32bit	Access		Address	H: 0x0054		
	Effective	Immediate				L: 0x0055		
The parameter description refers to Pr0.40, and the parameter setting method refers to Pr0.57. Note: The parameter Range, Unit, Access, etc. of Pr0.42 are determined by the parameter specified in Pr0.52								

Pr0.43 (Modbus)	Name	Mapping parameter 4			Mode	P	V	T
	Range		Unit		Default	0		
	Data length	32bit	Access		Address	H: 0x0056		
	Effective	Immediate				L: 0x0057		
The parameter description refers to Pr0.40, and the parameter setting method refers to Pr0.57. Note: The parameter Range, Unit, Access, etc. of Pr0.43 are determined by the parameter specified in Pr0.52.								

Pr0.44 (Modbus)	Name	Mapping parameter 5			Mode	P	V	T
	Range		Unit		Default	0		
	Data length	32bit	Access		Address	H: 0x0058		

	Effective	Immediate				L: 0x0059
The parameter description refers to Pr0.40, and the parameter setting method refers to Pr0.57. Note: The parameter Range, Unit, Access, etc. of Pr0.44 are determined by the parameter specified in Pr0.54.						

Pr0.45 (Modbus)	Name	Mapping parameter 6			Mode	P	V	T
	Range		Unit		Default	0		
	Data length	32bit	Access		Address	H: 0x005A		
	Effective	Immediate				L: 0x005B		
The parameter description refers to Pr0.40, and the parameter setting method refers to Pr0.57. Note: The parameter Range, Unit, Access, etc. of Pr0.45 are determined by the parameter specified in Pr0.55.								

Pr0.46 (Modbus)	Name	Mapping parameter 7			Mode	P	V	T
	Range		Unit		Default	0		
	Data length	32bit	Access		Address	H: 0x005C		
	Effective	Immediate				L: 0x005D		
The parameter description refers to Pr0.40, and the parameter setting method refers to Pr0.57. Note: The parameter Range, Unit, Access, etc. of Pr0.46 are determined by the parameter specified in Pr0.56.								

Pr0.47 (Modbus)	Name	Mapping parameter 8			Mode	P	V	T
	Range		Unit		Default	0		
	Data length	32bit	Access		Address	H: 0x005E		
	Effective	Immediate				L: 0x005F		
The parameter description refers to Pr0.40, and the parameter setting method refers to Pr0.57. Note: The parameter Range, Unit, Access, etc. of Pr0.47 are determined by the parameter specified in Pr0.57.								

Pr0.50 (Modbus)	Name	Mapping parameter 1 pointer			Mode	P	V	T
	Range	0~0xFFFFFFFF	Unit		Default	0x00490049		
	Data length	32bit	Access	R/W	Address	H: 0x0064		
	Effective	Immediate				L: 0x0065		

Pr0.51	Name	Mapping parameter 2 pointer			Mode	P	V	T
---------------	------	-----------------------------	--	--	------	----------	----------	----------

(Modbus)	Range	0~0xFFFFFFFF	Unit		Default	0x00490049
	Data length	32bit	Access	R/W	Address	H: 0x0066
	Effective	Immediate				L: 0x0067

Pr0.52 (Modbus)	Name	Mapping parameter 3 pointer			Mode	P	V	T
	Range	0~0xFFFFFFFF	Unit		Default	0x00490049		
	Data length	32bit	Access	R/W	Address	H: 0x0068		
	Effective	Immediate				L: 0x0069		

Pr0.53 (Modbus)	Name	Mapping parameter 4 pointer			Mode	P	V	T
	Range	0~0xFFFFFFFF	Unit		Default	0x00490049		
	Data length	32bit	Access	R/W	Address	H: 0x006A		
	Effective	Immediate				L: 0x006B		

Pr0.54 (Modbus)	Name	Mapping parameter 5 pointer			Mode	P	V	T
	Range	0~0xFFFFFFFF	Unit		Default	0x00490049		
	Data length	32bit	Access	R/W	Address	H: 0x006C		
	Effective	Immediate				L: 0x006D		

Pr0.55 (Modbus)	Name	Mapping parameter 6 pointer			Mode	P	V	T
	Range	0~0xFFFFFFFF	Unit		Default	0x00490049		
	Data length	32bit	Access	R/W	Address	H: 0x006E		
	Effective	Immediate				L: 0x006F		

Pr0.56 (Modbus)	Name	Mapping parameter 7 pointer			Mode	P	V	T
	Range	0~0xFFFFFFFF	Unit		Default	0x00490049		
	Data length	32bit	Access	R/W	Address	H: 0x0070		
	Effective	Immediate				L: 0x0071		

Pr0.57 (Modbus)	Name	Mapping parameter 8 pointer			Mode	P	V	T
	Range	0~0xFFFFFFFF	Unit		Default	0x00490049		
	Data length	32bit	Access	R/W	Address	H: 0x0072		
	Effective	Immediate				L: 0x0073		

Set the parameter as 0xABCDDWXYZ.

Then the high bit (PH) of the parameter and the low bit (PL) of the parameter are set in the following format: (PH) 0xABCD and (PL) 0xWXYZ.

PH bit	Content	PL bit	Content
CD	Parameter NO. - Value (Decimal)	YZ	Parameter NO. - Value (Decimal)
B	Parameter Class - Value (Hexadecimal)	X	Parameter Class - Value (Hexadecimal)
A	No effect	W	No effect

An example is as follows.

The Data length of Mapping parameter 1 - Pr0.40 is 32bit, so Pr0.40 can be mapped to two 16bit parameters or one 32bit parameter.

The content of Pr0.50 is as follows:

(mapping parameter 1 pointer: Pr0.50; value of mapping parameter 1: Pr0.40)

The high bit (PH) of Pr0.40 corresponds to the high bit of Pr0.50.

The low bit (PL) of Pr0.40 corresponds to the low bit of Pr0.50.

1. When the high bit value of Pr0.50 is not equal to the low bit value of Pr0.50 ($PH \neq PL$), it means that Pr0.40 is mapped to two 16bit mapping parameters.

If you set Pr0.50=0x06200101; that is, PH=0x0620, PL=0x0101; write 0x0005 0064 to Pr0.40; then it will write 0x0005 to parameter Pr6.20, and 0x0064 to parameter Pr1.01.

2. When the high bit value of Pr0.50 is equal to the low bit value of Pr0.50 ($PH=PL$), it means that Pr0.40 is mapped to one 32bit mapping parameter.

If you set Pr0.50=0x01150115; that is, PH=0x0115, PL=0x0115; write 0x00000001 to Pr0.40; then it will write 0x00000001 to parameter Pr1.15.

5.2.2 【Class 1】 Gain Adjust

Pr1.00	Name	1st gain of position loop			Mode	P		
	Range	0~30000	Unit	0.1/s	Default	320		
	Data length	16bit	Access	R/W	Address	0x 0101		
	Effective	Immediate						

You can determine the response of the positional control system.

Higher the gain of position loop you set, faster the positioning time you can obtain.

Note that too high setup may cause oscillation.

Pr1.01	Name	1st gain of velocity loop			Mode	P	V	T
	Range	0~32767	Unit	0.1Hz	Default	180		
	Data length	16bit	Access	R/W	Address	0x 0103		
	Effective	Immediate						

You can determine the response of the velocity loop.

In order to increase the response of overall servo system by setting high position loop gain, you need higher setup of this velocity loop gain as well. However, too high setup may cause oscillation.

Pr1.02	Name	1st time constant of velocity loop integration			Mode	P	V	T
	Range	0~10000	Unit	0.1ms	Default	310		
	Data length	16bit	Access	R/W	Address	0x 0105		

Effective	Immediate				
You can set up the integration time constant of velocity loop, Smaller the setup, faster you can dog-in deviation at stall to 0.The integration will be maintained by setting to"9999".The integration effect will be lost by setting to"10000".					

Pr1.03	Name	1st filter of velocity detection			Mode	P	V	T
	Range	50~81	Unit	—	Default	15		
	Data length	16bit	Access	R/W	Address	0x 0107		
	Effective	Immediate						

You can set up the time constant of the low pass filter (LPF) after the speed detection, in 32 steps (0 to 31).Higher the setup, larger the time constant you can obtain so that you can decrease the motor Noise, however, response becomes slow.

You can set the filter parameters through the loop gain, referring to the following table:

Set Value	Speed Detection Filter Cut-off Frequency(Hz)	Set Value	Speed Detection Filter Cut-off Frequency(Hz)
81	2500	65	750
80	2250	64	700
79	2100	63	650
78	2000	62	600
77	1800	61	550
76	1600	60	500
75	1500	59	450
74	1400	58	400
73	1300	57	350
72	1200	56	300
71	1100	55	250
70	1000	54	200
69	950	53	175
68	900	52	150
67	850	51	125
66	800	50	100

Pr1.04	Name	1st time constant of torque filter			Mode	P	V	T
	Range	0~2500	Unit	0.01ms	Default	126		
	Data length	16bit	Access	R/W	Address	0x 0109		
	Effective	Immediate						

Pr1.05	Name	2nd gain of position loop			Mode	P		
	Range	0~30000	Unit	0.1/s	Default	380		
	Data length	16bit	Access	R/W	Address	0x 010B		
	Effective	Immediate						

Pr1.06	Name	2nd gain of velocity loop			Mode	P	V	T
	Range	0~32767	Unit	0.1Hz	Default	180		
	Data length	16bit	Access	R/W	Address	0x 010D		
	Effective	Immediate						

Pr1.07	Name	2nd time constant of velocity loop integration			Mode	P	V	T
	Range	0~10000	Unit	0.1ms	Default	10000		
	Data length	16bit	Access	R/W	Address	0x 010F		
	Effective	Immediate						

Pr1.08	Name	2nd filter of velocity detection			Mode	P	V	T
	Range	0~31	Unit	—	Default	15		
	Data length	16bit	Access	R/W	Address	0x 0111		
	Effective	Immediate						

Pr1.09	Name	2nd time constant of torque filter			Mode	P	V	T
	Range	0~2500	Unit	0.01ms	Default	126		
	Data length	16bit	Access	R/W	Address	0x 0113		
	Effective	Immediate						

Position loop, velocity loop, velocity detection filter, torque command filter have their 2 pairs of gain or time constant (1st and 2nd).

Pr1.10	Name	Velocity feed forward gain			Mode	P		
	Range	0~1000	Unit	0.10%	Default	300		
	Data length	16bit	Access	R/W	Address	0x 0115		
	Effective	Immediate						

Multiply the velocity control command calculated according to the internal positional command by the ratio of this parameter and adds the result to the speed command resulting from the positional control process.

Pr1.11	Name	Velocity feed forward filter			Mode	P		
	Range	0~6400	Unit	0.01ms	Default	50		
	Data length	16bit	Access	R/W	Address	0x 0117		
	Effective	Immediate						

Set the time constant of 1st delay filter which affects the input of speed feed forward. **(usage example of velocity feed forward)**

The velocity feed forward will become effective as the velocity feed forward gain is

gradually increased with the speed feed forward filter set at approx.50 (0.5ms). The positional deviation during operation at a constant speed is reduced as shown in the equation below in proportion to the value of velocity feed forward gain.

$$\text{Position deviation [unit of command]} = \text{command speed [unit of command /s]} / \text{position loop gain[1/s]} \times (100 - \text{speed feed forward gain[\%]} / 100)$$

Pr1.12	Name	Torque feed forward gain			Mode	P	V
	Range	0~1000	Unit	0.1%	Default	0	
	Data length	16bit	Access	R/W	Address	0x 0119	
	Effective	Immediate					
<ul style="list-style-type: none"> ● Multiply the torque control command calculated according to the velocity control command by the ratio of this parameter and adds the result to the torque command resulting from the velocity control process. ● To use torque feed forward, correctly set ratio of inertia. Set the inertia ratio that can be calculated from the machine specification to Pr0.04 inertia ratio. ● Positional deviation at a constant acceleration/deceleration can be minimized close to 0 by increasing the torque forward gain .this means that positional deviation can be maintained at near 0 over entire operation range while driving in trapezoidal speed pattern under ideal condition where disturbance torque is Not active. 							

Pr1.13	Name	Torque feed forward filter			Mode	P	V
	Range	0~6400	Unit	0.01ms	Default	0	
	Data length	16bit	Access	R/W	Address	0x 011B	
	Effective	Immediate					
<p>Set up the time constant of 1st delay filter which affects the input of torque feed forward.</p> <p>zero positional deviation is impossible in actual situation because of disturbance torque. as with the velocity feed forward, large torque feed forward filter time constant decreases the operating Noise but increases positional deviation at acceleration change point.</p>							

Pr1.15	Name	Mode of position control switching			Mode	P	
	Range	0~10	Unit	—	Default	0	
	Data length	16bit	Access	R/W	Address	0x 011F	
	Effective	Immediate					
Setup Value	Switching Condition	Gain Switching Condition					
0	Fixed to 1st gain	Fixed to the 1st gain (Pr1.00-Pr1.04)					
1	Fixed to 2nd gain	Fixed to the 2nd gain (Pr1.05-Pr1.09)					
2	with gain switching input	<ul style="list-style-type: none"> ● 1st gain when the gain switching input is open. ● 2nd gain when the gain switching input is connected to com- . ◇ If No. input signal is allocated to the gain switching input, the 1st gain is fixed. 					
3	Torque command is large	<ul style="list-style-type: none"> ● Shift to the 2nd gain when the absolute value of the torque command exceeded (level + hysteresis)[%] previously with the 1st gain. ● Return to the 1st gain when the absolute value of the torque 					

		command was kept below (level + hysteresis) [%] previously during delay time with the 2nd gain.
4-9	reserved	reserved
10	Have position command + actual speed	<ul style="list-style-type: none"> ● Valid for position control. ● Shift to the 2nd gain when the positional command was Not 0 previously with the 1st gain. ● Return to the 1st gain when the positional command was kept at 0 during the delay time and the absolute value of actual speed was kept below (level - hysteresis) (r/min) previously with the 2nd gain.

Pr1.17	Name	Level of position control switching			Mode	P		
	Range	0~20000	Unit	Mode specific	Default	50		
	Data length	16bit	Access	R/W	Address	0x 0123		
	Effective	Immediate						
Unit of setting varies with switching mode. Switching condition: Position: encoder pulse number; speed: r/min; torque: %. Notice: set the level equal to or higher than the hysteresis.								

Pr1.18	Name	Hysteresis at position control switching			Mode	P		
	Range	0~20000	Unit	Mode specific	Default	33		
	Data length	16bit	Access	R/W	Address	0x 0125		
	Effective	Immediate						
Combining Pr1.17(control switching level)setup Notice: when level< hysteresis, the hysteresis is internally adjusted so that it is equal to level.								

Pr1.19	Name	Position gain switching time			Mode	P		
	Range	0~10000	Unit	0.1ms	Default	33		
	Data length	16bit	Access	R/W	Address	0x 0127		
	Effective	Immediate						

For position controlling: if the difference between 1st gain and 2nd gain is large, the increasing rate of position loop gain can be limited by this parameter.

<Position gain switching time>

Notice: when using position control, position loop gain rapidly changes, causing torque change and vibration. By adjusting Pr1.19 position gain switching time, increasing rate of the position loop gain can be decreased and variation level can be reduced.

Example: 1st (pr1.00) <-> 2nd (Pr1.05)

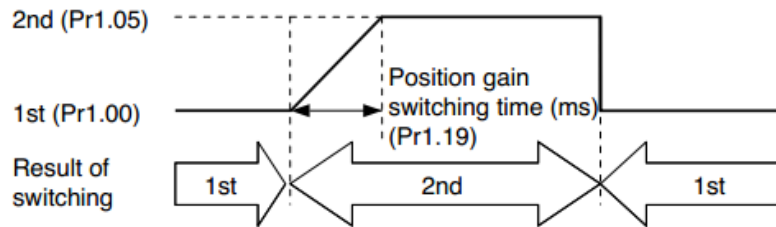

Pr1.35*	Name	Positional command filter setup			Mode	P		
	Range	0~200	Unit	0.05us	Default	0		
	Data length	16bit	Access	R/W	Address	0x 0147		
	Effective	Immediate						
Do filtering for positional command pulse, eliminate the interference of the narrow pulse, over-large setup will influence the input of high frequency positional command pulse, and make more time-delayed.								

Pr1.37	Name	Special register			Mode	P	V	T
	Range	0~0xFFFF	Unit	-	Default	0		
	Data length	16bit	Access	R/W	Address	0x 2137		
	Effective	Immediate						
Under binary, these bits in register are used for some function operation. Bit2=1, shield the speed out of control alarm (1A1) Bit4=1, shield the over-load alarm 100,101 Bit6=1, shield the excessive vibration alarm 190 Bit7=1, shield the braking resistor over-load alarm 120 Bit9=1, shield the lacking of phase alarm0dl (other bits are forbidden to use, default 0) For example : Pr137 = 4 can be used to shield alarm code 1A1 Pr137 = 64 can be used to shield alarm code 190 Pr137 =68 can be used to shield both 1A1 and 190.								

5.2.3 【Class 2】 Vibration Suppression

Pr2.00	Name	Adaptive filter mode setup			Mode	P	V	
	Range	0~4	Unit	—	Default	0		
	Data length	16bit	Access	R/W	Address	0x 0201		
	Effective	Immediate						

Set up the resonance frequency to be estimated by the adaptive filter and the special the operation after estimation.

Setup Value	Details	
0	Adaptive filter: invalid	Parameters related to the 3rd and 4th Notch filter hold the current value.
1	Adaptive filter, 1 filter is valid, one time	One adaptive filter is valid, parameters related to the 3rd Notch filter will be updated based on adaptive performance. After updated, Pr2.00 returns to 0, stop self-adaptation.
2	Adaptive filter, 1 filter is valid, It will be valid all the time	One adaptive filter is valid, parameters related to the 3rd Notch filter will be updated all the time based on adaptive performance.
3-4	Not use	Forbid Non-professional to use

Pr2.01	Name	1st notch frequency			Mode	P	V	T
	Range	50~2000	Unit	Hz	Default	2000		
	Data length	16bit	Access	R/W	Address	0x 0203		
	Effective	Immediate						

Set the center frequency of the 1st Notch filter

Notice: the Notch filter function will be invalid by setting up this parameter to “2000”.

Pr2.02	Name	1st notch width selection			Mode	P	V	T
	Range	0~20	Unit	—	Default	2		
	Data length	16bit	Access	R/W	Address	0x 0205		
	Effective	Immediate						

Set the width of Notch at the center frequency of the 1st Notch filter.

Notice: Higher the setup, larger the Notch width you can obtain. Use with default setup in Normal operation.

Pr2.03	Name	1st notch depth selection			Mode	P	V	T
	Range	0~99	Unit	—	Default	0		
	Data length	16bit	Access	R/W	Address	0x 0207		
	Effective	Immediate						

Set the depth of Notch at the center frequency of the 1st Notch filter.

Notice: Higher the setup, shallower the Notch depth and smaller the phase delay you can obtain.

Pr2.04	Name	2nd notch frequency			Mode	P	V	T
	Range	50~2000	Unit	Hz	Default	2000		
	Data length	16bit	Access	R/W	Address	0x 0209		
	Effective	Immediate						

Set the center frequency of the 2nd Notch filter

Notice: the Notch filter function will be invalid by setting up this parameter to “2000”.

Pr2.05	Name	2nd notch width selection			Mode	P	V	T
	Range	0~20	Unit	—	Default	2		
	Data length	16bit	Access	R/W	Address	0x 020B		
	Effective	Immediate						

Set the width of Notch at the center frequency of the 2nd Notch filter.
 Notice: Higher the setup, larger the Notch width you can obtain. Use with default setup in Normal operation.

Pr2.06	Name	2nd notch depth selection			Mode	P	V	T
	Range	0~99	Unit	—	Default	0		
	Data length	16bit	Access	R/W	Address	0x 020D		
	Effective	Immediate						

Set the depth of Notch at the center frequency of the 2nd Notch filter.
 Notice: Higher the setup, shallower the Notch depth and smaller the phase delay you can obtain.

Pr2.07	Name	3rd notch frequency			Mode	P	V	T
	Range	50~2000	Unit	Hz	Default	2000		
	Data length	16bit	Access	R/W	Address	0x 020F		
	Effective	Immediate						

Set the center frequency of the 3rd Notch filter
 Notice: the Notch filter function will be invalid by setting up this parameter to “2000”.

Pr2.08	Name	3rd notch width selection			Mode	P	V	T
	Range	0~20	Unit	—	Default	2		
	Data length	16bit	Access	R/W	Address	0x 0211		
	Effective	Immediate						

Set the width of Notch at the center frequency of the 3rd Notch filter.
 Notice: Higher the setup, larger the Notch width you can obtain. Use with default setup in Normal operation.

Pr2.09	Name	3rd notch depth selection			Mode	P	V	T
	Range	0~99	Unit	—	Default	0		
	Data length	16bit	Access	R/W	Address	0x 0213		
	Effective	Immediate						

Set the depth of Notch at the center frequency of the 3rd Notch filter.
 Notice: Higher the setup, shallower the Notch depth and smaller the phase delay you can obtain.

Pr2.14*	Name	1st damping frequency			Mode	P		
	Range	10~2000	Unit	0.1HZ	Default	0		
	Data length	16bit	Access	R/W	Address	0x 021D		

	Effective	Immediate				
0: close Setup damping frequency, to suppress vibration at the load edge.						
Pr2.16*	Name	2nd damping frequency			Mode	P
	Range	10~2000	Unit	0.1HZ	Default	0
	Data length	16bit	Access	R/W	Address	0x 0221
	Effective	Immediate				
0: close Setup damping frequency, to suppress vibration at the load edge						

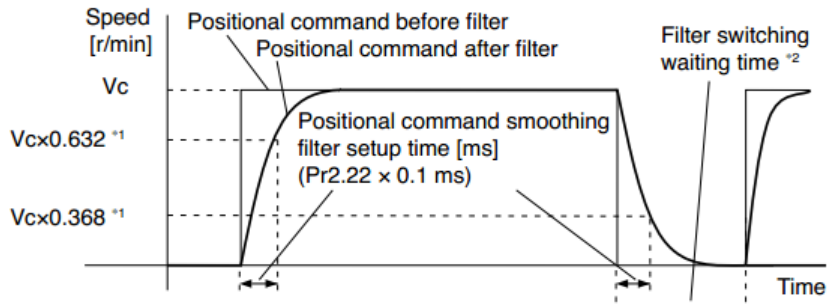
Pr2.22	Name	Positional command smoothing filter			Mode	P
	Range	0~32767	Unit	0.1ms	Default	0
	Data length	16bit	Access	R/W	Address	0x 022D
	Effective	Power-on again				
<ul style="list-style-type: none"> Set up the time constant of the 1st delay filter in response to the positional command. When a square wave command for the target speed V_c is applied ,set up the time constant of the 1st delay filter as shown in the figure below 						
						

Pr2.23	Name	Positional command FIR filter			Mode	P
	Range	0~10000	Unit	0.1ms	Default	0
	Data length	16bit	Access	R/W	Address	0x 022F
	Effective	Power-on again				

- Set up the time constant of the 1st delay filter in response to the positional command.
- When a square wave command for the target speed V_c is applied, set up the V_c arrival time as shown in the figure below.

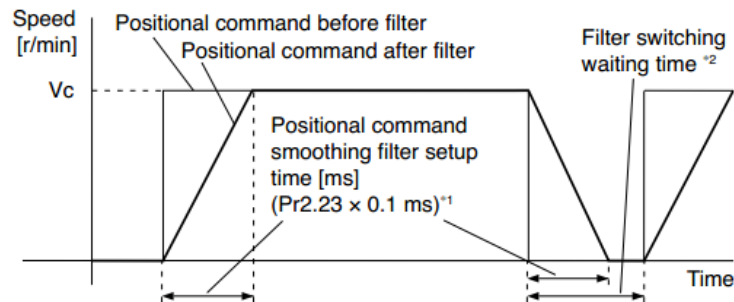

5.2.4 【Class 3】 Velocity/ Torque Control

Pr3.00	Name	Speed setup, Internal /External switching			Mode	V
	Range	0~3	Unit	—	Default	0
	Data length	16bit	Access	R/W	Address	0x 0301
	Effective	Immediate				

This drive is equipped with internal speed setup function so that you can control the speed with contact inputs only.

Setup Value	Speed Setup Method
0	Analog speed command(SPR)
1	Internal speed command 1st to 4th speed(Pr3.04-Pr3.07)
2	Internal speed command 1st to 3rd speed (Pr3.04-Pr3.06), Analog speed command(SPR)
3	Internal speed command 1st to 8th speed (Pr3.04-Pr3.11)

<relationship between Pr3.00 Internal/External switching speed setup and the internal command speed selection 1-3 and speed command to be selected>

Setup Value	1 st Selection Of Internal Command Speed (Intspd1)	2 nd Selection Of Internal Command Speed (Intspd2)	3 rd Selection Of Internal Command Speed (Intspd3)	Selection Of Speed Command
1	OFF	OFF	NO. effect	1st speed
	ON	OFF		2nd speed
	OFF	ON		3rd speed
	ON	ON		4th speed
2	OFF	OFF	NO. effect	1st speed
	ON	OFF		2nd speed
	OFF	ON		3rd speed
	ON	ON		Analog speed command
3	The same as [Pr3.00=1]		OFF	1st to 4th speed
	OFF	OFF	ON	5th speed
	ON	OFF	ON	6th speed
	OFF	ON	ON	7th speed

		ON	ON	ON	8th speed
--	--	----	----	----	-----------

Pr3.01	Name	Speed command rotational direction selection		Mode	V
	Range	0~1	Unit	—	Default 0
	Data length	16bit	Access	R/W	Address 0x 0303
	Effective	Immediate			

Select the Positive /Negative direction specifying method

Setup Value	Velocity Value	Velocity Command Signal(VC-SIGN)	Velocity Command Direction
0	+	No. effect	Positive direction
	-	No. effect	Negative direction
1	Sign Not effect	OFF	Positive direction
	Sign Not effect	ON	Negative direction

Pr3.02	Name	Input gain of speed command		Mode	V
	Range	10~2000	Unit	(r/min)/V	Default 500
	Data length	16bit	Access	R/W	Address 0x 0305
	Effective	Immediate			

Based on the voltage applied to the analog speed command (SPR), set up the conversion gain to motor command speed.
 You can set up “slope” of relation between the command input voltage and motor speed, with Pr3.02. Default is set to Pr3.02=500(r/min)/V, hence input of 6V becomes 3000r/min.

Notice:

1. Do Not apply more than $\pm 10V$ to the speed command input(SCR).
2. When you compose a position loop outside of the drive while you use the drive in velocity control mode, the setup of Pr3.02 gives larger variance to the overall servo system.
3. Pay an extra attention to oscillation caused by larger setup of Pr3.02

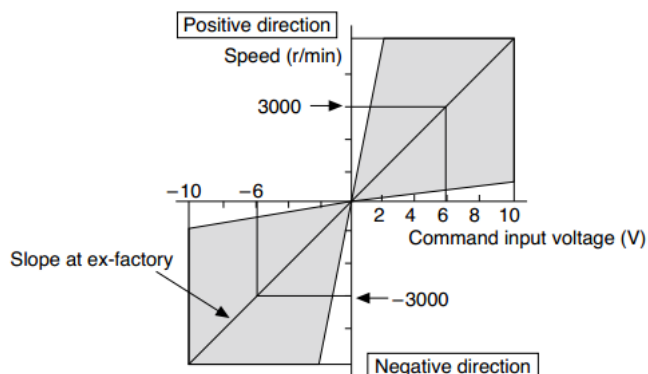

Pr3.03	Name	Reversal of speed command input		Mode	V
	Range	0~1	Unit	—	Default 1
	Data length	16bit	Access	R/W	Address 0x 0307

Effective	Immediate				
Specify the polarity of the voltage applied to the analog speed command (SPR).					
Setup Value		Motor Rotating Direction			
0	Standard	[+ voltage] → [+ direction] \ [- voltage] → [-direction]			
1	Reversed	[+ voltage] → [- direction] \ [- voltage] → [+direction]			
Caution: When you compose the servo drive system with this drive set to velocity control mode and external positioning unit, the motor might perform an abnormal action if the polarity of the speed command signal from the unit and the polarity of this parameter setup do Not match.					

Pr3.04	Name	1st speed of speed setup			Mode	V
	Range	-10000~10000	Unit	r/min	Default	
	Data length	16bit	Access	R/W	Address	0x0309
	Effective	Immediate				
Pr3.05	Name	2nd speed of speed setup			Mode	V
	Range	-10000~10000	Unit	r/min	Default	
	Data length	16bit	Access	R/W	Address	0x 030B
	Effective	Immediate				
Pr3.06	Name	3rd speed of speed setup			Mode	V
	Range	-10000~10000	Unit	r/min	Default	
	Data length	16bit	Access	R/W	Address	0x 030D
	Effective	Immediate				
Pr3.07	Name	4th speed of speed setup			Mode	V
	Range	-10000~10000	Unit	r/min	Default	
	Data length	16bit	Access	R/W	Address	0x 030F
	Effective	Immediate				
Pr3.08	Name	5th speed of speed setup			Mode	V
	Range	-10000~10000	Unit	r/min	Default	
	Data length	16bit	Access	R/W	Address	0x 0311
	Effective	Immediate				
Pr3.09	Name	6th speed of speed setup			Mode	V
	Range	-10000~10000	Unit	r/min	Default	
	Data length	16bit	Access	R/W	Address	0x 0313
	Effective	Immediate				
Pr3.10	Name	7th speed of speed setup			Mode	V
	Range	-10000~10000	Unit	r/min	Default	
	Data length	16bit	Access	R/W	Address	0x 0315

	Effective	Immediate				
Pr3.11	Name	8th speed of speed setup			Mode	V
	Range	-10000~10000	Unit	r/min	Default	0
	Data length	16bit	Access	R/W	Address	0x 0317
	Effective	Immediate				
Set up internal command speeds, 1st to 8th						

Pr3.12	Name	Time setup acceleration			Mode	V
	Range	0~10000	Unit	Ms/ (1000r/min)	Default	100
	Data length	16bit	Access	R/W	Address	0x 0319
	Effective	Immediate				
Pr3.13	Name	Time setup deceleration			Mode	V
	Range	0~10000	Unit	Ms/ (1000r/min)	Default	100
	Data length	16bit	Access	R/W	Address	0x 031B
	Effective	Immediate				

Set up acceleration/deceleration processing time in response to the speed command input.

Set the time required for the speed command(stepwise input)to reach 1000r/min to Pr3.12

Acceleration time setup. Also set the time required for the speed command to reach from 1000r/min to 0 r/min, to Pr3.13 deceleration time setup.

Assuming that the target value of the speed command is V_c (r/min), the time required for acceleration/deceleration can be computed from the formula shown below.

$$\text{Acceleration time (ms)} = V_c / 1000 * \text{Pr3.12} * 1\text{ms}$$

$$\text{Deceleration time (ms)} = V_c / 1000 * \text{Pr3.13} * 1\text{ms}$$

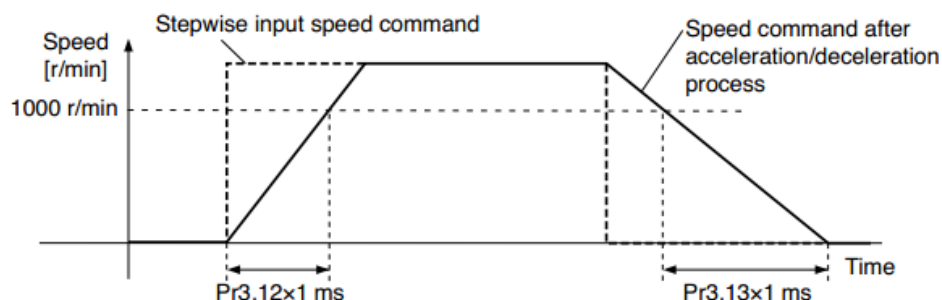

Pr3.14	Name	Sigmoid acceleration /deceleration time setup			Mode	V
	Range	0~1000	Unit	ms	Default	0
	Data length	16bit	Access	R/W	Address	0x 031D
	Effective	Power-on again				

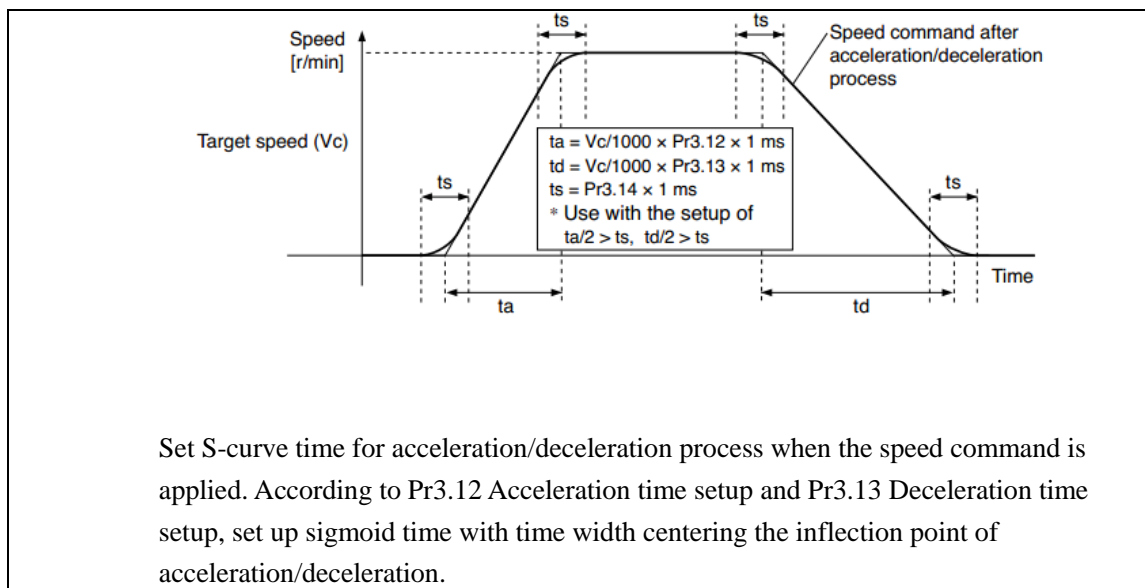

Pr3.15	Name	Speed zero-clamp function selection			Mode	V
	Range	0~3	Unit	0.1HZ	Default	0
	Data length	16bit	Access	R/W	Address	0x 031F
	Effective	Immediate				
<ol style="list-style-type: none"> If Pr3.15=0, the function of zero clamp is forbidden. It means the motor rotates with actual velocity which is controlled by the analog voltage input 1 even if the velocity is less than 10 rpm. The motor runs No. matter what the value of Pr3.16 is. The actual velocity is controlled by external the analog voltage input. If Pr3.15=1 and the input signal of Zero Speed is available in the same time, the function of zero clamp works. It means motor will stop rotating in servo-on condition No. matter what the velocity of motor is, and motor stop rotating No. matter what the value of Pr3.16 is. If Pr3.15=2, the function of zero clamp belongs to the value of Pr3.16. If the actual velocity is less than the value of Pr3.16, the motor will stop rotating in servo-on condition. 						

Pr3.16	Name	Speed zero-clamp level			Mode	V
	Range	10~2000	Unit	r/min	Default	30
	Data length	16bit	Access	R/W	Address	0x 0321
	Effective	Immediate				
When analog speed command value less than speed zero-clamp level setup, actual speed will set to 0.						

Pr3.17	Name	Selection of torque command			Mode	T									
	Range	0/1/2	Unit		Default	0									
	Data length	16bit	Access	R/W	Address	0x 0323									
	Effective	Immediate													
<table border="1" style="width: 100%; border-collapse: collapse;"> <tr> <td>Setup value</td> <td>Torque command input</td> <td>Velocity limit input</td> </tr> <tr> <td>0</td> <td>Analog input 3</td> <td>Parameter value (P3.21)</td> </tr> <tr> <td>1</td> <td>Analog input 3</td> <td>Analog input 1 for Speed limit</td> </tr> </table>							Setup value	Torque command input	Velocity limit input	0	Analog input 3	Parameter value (P3.21)	1	Analog input 3	Analog input 1 for Speed limit
Setup value	Torque command input	Velocity limit input													
0	Analog input 3	Parameter value (P3.21)													
1	Analog input 3	Analog input 1 for Speed limit													

	2	Parameter value (P3.22)	Parameter value (P3.21)
	3	Analog input 3	Speed limit 0

Pr3.18	Name	Torque command direction selection		Mode		T
	Range	0~1	Unit	—	Default	0
	Data length	16bit	Access	R/W	Address	0x 0325
	Effective	Immediate				
Select the direction positive/negative direction of torque command						
		Setup Value	Details			
		0	Specify the direction with the sign of torque command Torque command input[+] → positive direction, [-] → negative direction			
		1	Specify the direction with torque command sign(TC-SIGN). OFF: positive direction ON: negative direction			

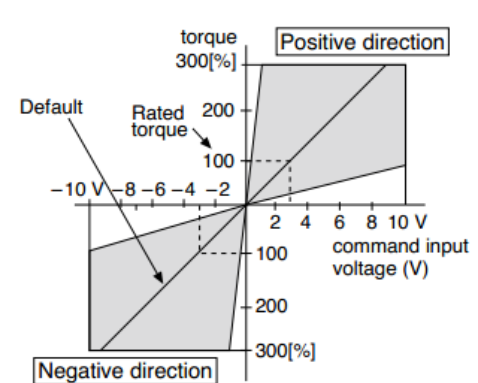
Pr3.19	Name	Torque command input gain		Mode		T
	Range	10~100	Unit	0.1V/100%	Default	0
	Data length	16bit	Access	R/W	Address	0x 0327
	Effective	Immediate				
Based on the voltage (V) applied to the analog torque command (TRQR),set up the conversion gain to torque command(%)						
<ul style="list-style-type: none"> ● Unit of the setup value is 0.1V/100%] and set up input voltage necessary to produce the rated torque. ● Default setup of 30 represents 3V/100% 						
						

Pr3.20	Name	Torque command input reversal		Mode		T
	Range	0~1	Unit	—	Default	0
	Data length	16bit	Access	R/W	Address	0x 0329
	Effective	Immediate				

Set up the polarity of the voltage applied to the analog torque command (TRQR).

Setup Value	Direction Of Motor Output Torque	
0	Non-reversal	[+ voltage]→ [+ direction] [- voltage]→ [-direction]
1	reversal	[+ voltage]→ [- direction] [- voltage]→ [+direction]

Pr3.21	Name	Speed limit value 1			Mode			T
	Range	0~10000	Unit	r/min	Default	0		
	Data length	16bit	Access	R/W	Address	0x 032B		
	Effective	Immediate						

Set up the speed limit used for torque control.

During the torque controlling, the speed set by the speed limit cannot be exceeded.

Pr3.22	Name	Torque command			Mode			T
	Range	0~300	Unit	%	Default	0		
	Data length	16bit	Access	R/W	Address	0x 032D		
	Effective	Immediate						

Set up torque limit value in torque mode control.

Pr3.23	Name	Speed zero-motor standstill delay time			Mode		V	
	Range	0~2000	Unit	ms	Default	0		
	Data length	16bit	Access	R/W	Address	0x032F		
	Effective	Immediate						

Set the “Speed Zero-Motor Standstill delay time Pr3.23” in velocity control mode, it is the time between the speed reaching below the Speed Zero-Clamp level and the motor standstill.

It mainly prevents the motor from rotating slowly When the zero speed clamp is in effect.

When Pr3.23 set to 0, the function is invalid.

When Pr3.23 set to 1~2000, the motor speed reaches below the Pr3.16 Speed zero-clamp level, and then the motor is stationary after the set time.

Pr3.24 *	Name	Motor rotate maximum speed limit			Mode	P	V	T
	Range	0~10000	Unit	r/min	Default	3000		
	Data length	16bit	Access	R/W	Address	0x 0331		
	Effective	Immediate						

Set up motor running max rotate speed, but can't be exceeded motor allowed max rotate speed.

Pr3.29	Name	Analog 1 clamp voltage			Mode			T
	Range	0~20000	Unit	mv	Default	0		
	Data length	16bit	Access	R/W	Address	0x033B		
	Effective	Immediate						
Set the clamp voltage of analog 1, it is effective only when Pr3.17 is set to 1. For example: Pr3.17=1, when the analog 1 (AI1) is equal or lesser than the Pr3.29 set value, the motor speed is set to 0 directly.								
Pr3.30	Name	Analog 3 clamp voltage			Mode			T
	Range	0~20000	Unit	mv	Default	0		
	Data length	16bit	Access	R/W	Address	0x033D		
	Effective	Immediate						
Set the clamp voltage of analog 3, it is effective only when Pr3.17 is set to 0 or 1. For example: Pr3.17=1, when the analog 3 (AI1) is equal or lesser than the Pr3.30 set value, the motor speed is set to 0 directly.								

Pr3.62	Name	Velocity analog			Mode		V	T
	Range	-32767~32768	Unit	mv	Default	0		
	Data length	16bit	Access	R/W	Address	0x037D		
	Effective	Immediate						
Set the Velocity Analog via Modbus connection, it is effective only when Pr3.17 is set to 3.								
Pr3.63	Name	Torque analog			Mode			T
	Range	-32767~32768	Unit	mv	Default	0		
	Data length	16bit	Access	R/W	Address	0x037F		
	Effective	Immediate						
Set the Torque Analog via Modbus connection, it is effective only when Pr3.17 is set to 3.								

5.2.5 【Class 4】 I/F Monitor Setting

Pr4.00 *	Name	Input selection SI1			Mode	P	V	T
	Range	0~00FFFFFFh	Unit	—	Default	3		
	Data length	16bit	Access	R/W	Address	0x 0401H		
	Effective	Power-on again						
Pr4.01 *	Name	Input selection SI2			Mode	P	V	T
	Range	0~00FFFFFFh	Unit	—	Default	0		
	Data length	16bit	Access	R/W	Address	0x 0403		
	Effective	Power-on again						
Pr4.02 *	Name	Input selection SI3			Mode	P	V	T

	Range	0~00FFFFFFh	Unit	—	Default	0
	Data length	16bit	Access	R/W	Address	0x 0405
	Effective	0				
Pr4.03 *	Name	Input selection SI4			Mode	P V T
	Range	0~00FFFFFFh	Unit	—	Default	0
	Data length	16bit	Access	R/W	Address	0x 0207
	Effective	Power-on again				
Pr4.04 *	Name	Input selection SI5			Mode	P V T
	Range	0~00FFFFFFh	Unit	—	Default	0
	Data length	16bit	Access	R/W	Address	0x 0409
	Effective	Power-on again				
Pr4.05 *	Name	Input selection SI6			Mode	P V T
	Range	0~00FFFFFFh	Unit	—	Default	0
	Data length	16bit	Access	R/W	Address	0x 040B
	Effective	Power-on again				
Pr4.06 *	Name	Input selection SI7			Mode	P V T
	Range	0~00FFFFFFh	Unit	—	Default	0
	Data length	16bit	Access	R/W	Address	0x 040D
	Effective	Power-on again				
Pr4.07 *	Name	Input selection SI8			Mode	P V T
	Range	0~00FFFFFFh	Unit	—	Default	0
	Data length	16bit	Access	R/W	Address	0x 040F
	Effective	Power-on again				
Pr4.08 *	Name	Input selection SI9			Mode	P V T
	Range	0~00FFFFFFh	Unit	—	Default	0
	Data length	16bit	Access	R/W	Address	0x 0411
	Effective	Power-on again				

Set digital SI input function allocation.

This parameter use 16 binary system to set up the values,

For the function number, please refer to the following Figure.

Signal Name	Symbol	Setup Value	
		Normally Open	Normally Closed
Invalid	-	00h	Do not setup
Positive direction over-travel inhibition	POT	01h	81h
Negative direction over-travel inhibition	NOT	02h	82h
Servo-ON input	SRV-ON	03h	83h
Alarm clear input	A-CLR	04h	Do not setup

Control mode switching input	C-MODE	05h	85h
Gain switching input	GAIN	06h	86h
Deviation counter clear input	CL	07h	Do not setup
Command pulse inhibition input	INH	08h	88h
Torque switching	TC-SEL	09h	89h
Electronic gear switching input 1	DIV1	0Ch	8Ch
Electronic gear switching input 2	DIV2	0Dh	8Dh
Selection 1 input of internal command speed	INTSPD1	0Eh	8Eh
Selection 2 input of internal command speed	INTSPD2	0Fh	8Fh
Selection 3 input of internal command speed	INTSPD3	10h	90h
Speed zero clamp input	ZEROSPD	11h	91h
Speed command sign input	VC-SIGN	12h	92h
Torque command sign input	TC-SIGN	13h	93h
Forced alarm input	E-STOP	14h	94h

Note:

- Normally open means input signal comes from external controller or component, for example: PLC .
- Normally closed means input signal comes from drive internally.
- Don't setup to a value other than that specified in the table.
- Don't assign specific function to 2 or more signals. Duplicated assignment will cause Err21.0 I/F input multiple assignment error 1 or Err21.1 I/F input multiple assignment error 2

PR-Mode related input setup as below:

		Input	
Signal Name	Symbol	Setup Value	
		Normally Open	Normally Closed
Trigger command	CTRG	20h	A0h
Homing signal	HOME	21h	A1h
Forced stop	STP	22h	A2h
Forward direction JOG	JOG+	23h	A3h
Opposite direction JOG	JOG-	24h	A4h
Positive limit switch	PL	25h	A5h
Negative limit switch	NL	26h	A6h
Homing switch signal	ORG	27h	A7h
Road strength address 0	ADD0	28h	A8h
Road strength address 1	ADD1	29h	A9h
Road strength address 2	ADD2	2ah	Aah
Road strength address 3	ADD3	2bh	Abh

Note:

CTRG, HOME is edge triggered; the active duration must more than 1ms.

Pr4.10 *	Name	Output selection SO1			Mode	P	V	T
	Range	0~00FFFFFFh	Unit	—	Default	101		
	Data length	16bit	Access	R/W	Address	0x 0415		
	Effective	Power-on again						
Pr4.11 *	Name	Output selection SO2			Mode	P	V	T
	Range	0~00FFFFFFh	Unit	—	Default	202		
	Data length	16bit	Access	R/W	Address	0x 0417		
	Effective	Power-on again						
Pr4.12 *	Name	Output selection SO3			Mode	P	V	T
	Range	0~00FFFFFFh	Unit	—	Default	404		

	Data length	16bit	Access	R/W	Address	0419H
	Effective	Power-on again				
Pr4.13 *	Name	Output selection SO4			Mode	P V T
	Range	0~00FFFFFFh	Unit	—	Default	303
	Data length	16bit	Access	R/W	Address	0x 041B
	Effective	Power-on again				
Pr4.14 *	Name	Output selection SO5			Mode	P V T
	Range	0~00FFFFFFh	Unit	—	Default	101
	Data length	16bit	Access	R/W	Address	0x 041D
	Effective	Power-on again				
Pr4.15 *	Name	Output selection SO6			Mode	P V T
	Range	0~00FFFFFFh	Unit	—	Default	303
	Data length	16bit	Access	R/W	Address	0x 041F
	Effective	Power-on again				

Set digital SO output functions allocation.
 This parameter use 16 binary system do setup
 For the function number, please refer to the following Figure.

Signal Name	Symbol	Setup Value
Invalid	-	00h
Alarm output	Alm	01h
Servo-Ready output	S-RDY	02h
External brake release signal	BRK-OFF	03h
Positioning complete output	INP	04h
At-speed output	AT-SPPED	05h
Zero-speed detection output	ZSP	07h
Velocity coincidence output	V-COIN	08h
Positional command ON/OFF output	P-CMD	0Bh
Speed command ON/OFF output	V-CMD	0Fh

PR-Mode related output setup as below;

Output			
Signal Name	Symbol	Setup Value	
		Normally Open	Normally Closed
Command complete	CMD-OK	20h	A0h
Road strength address	MC-OK	21h	A1h
Homing finish	HOME-OK	22h	A2h
Torque limit	TQL	06h	86h

Note:

CMD-OK indicates PR command sent complete, but the motor may Not in-position.
 MC-OK indicates command complete and the motor in-position.

*Pay attention to the front panel display is hexadecimal.

Pr4.22	Name	Analog input 1 (AI1) offset setup			Mode	V
	Range	-5578~5578	Unit	—	Default	0

	Data length	16bit	Access	R/W	Address	0x 042D
	Effective	Immediate				
Set up the offset correction value applied to the voltage fed to the analog input 1.						

Pr4.23	Name	Analog input 1 (AI1) filter			Mode	V
	Range	0~6400	Unit	0.01ms	Default	0
	Data length	16bit	Access	R/W	Address	0x 042F
	Effective	Immediate				
Set up the time constant of 1st delay filter that determines the lag time behind the voltage applied to the analog input 1.						

Pr4.24	Name	Analog input 1 (AI1) over -voltage setup			Mode	V
	Range	0~100	Unit	0.1v	Default	0
	Data length	16bit	Access	R/W	Address	0x 0431
	Effective	Immediate				
Set up the excessive level of the input voltage of analog input 1 by using the voltage associated with offset						

Pr4.28	Name	Analog input 3 (AI3) offset setup			Mode	T
	Range	-342~342	Unit	—	Default	0
	Data length	16bit	Access	R/W	Address	0x 0439
	Effective	Immediate				
Set up the offset correction value applied to the voltage fed to the analog input 3.						

Pr4.29	Name	Analog input 3 (AI3) filter			Mode	T
	Range	0~6400	Unit	0.01ms	Default	0
	Data length	16bit	Access	R/W	Address	0x 043B
	Effective	Immediate				
Set up the time constant of 1st delay filter that determines the lag time behind the voltage applied to the analog input 3.						

Pr4.30	Name	Analog input 3 (AI3) overvoltage setup			Mode	T
	Range	0~100	Unit	0.1v	Default	0
	Data length	16bit	Access	R/W	Address	0x 043D
	Effective	Immediate				
Set up the excessive level of the input voltage of analog input 3 by using the voltage associated with offset.						

Pr4.31	Name	Positioning complete range			Mode	P		
	Range	0~10000	Unit	0.0001rev	Default	10		
	Data length	16bit	Access	R/W	Address	0x 043F		
	Effective	Immediate						
Set up the timing of positional deviation at which the positioning complete signal (INP1) is output.								

Pr4.32	Name	Positioning complete output setup			Mode	P		
	Range	0~3	Unit	command unit	Default	0		
	Data length	16bit	Access	R/W	Address	0x 0441		
	Effective	Immediate						
Select the condition to output the positioning complete signal (INP1).								
Setup Value		Action Of Positioning Complete Signal						
0		The signal will turn on when the positional deviation is smaller than Pr4.31 [positioning complete range].						
1		The signal will turn on when there is No. position command and position deviation is smaller than Pr4.31 [positioning complete range].						
2		The signal will turn on when there is No. position command, the zero-speed detection signal is ON and the positional deviation is smaller than Pr4.31 [positioning complete range].						
3		The signal will turn on when there is No. position command and the positional deviation is smaller than Pr4.31 [positioning complete range]. Then holds "ON" states until the next position command is entered. Subsequently, ON state is maintained until Pr4.33 INP hold time has elapsed. After the hold time, INP output will be turned ON/OFF according to the coming positional command or condition of the positional deviation.						

Pr4.33	Name	INP hold time			Mode	P		
	Range	0~30000	Unit	1ms	Default	0		
	Data length	16bit	Access	R/W	Address	0x 0443		
	Effective	Immediate						
Set up the hold time when Pr 4.32 positioning complete output setup=3								
Setup Value		State Of Positioning Complete Signal						
0		The hold time is maintained definitely, keeping ON state until next positional command is received.						
1-30000		ON state is maintained for setup time (ms) but switched to OFF state as the positional command is received during hold time.						

Pr4.34	Name	Zero-speed			Mode	P	V	T
	Range	10~20000	Unit	r/min	Default	50		
	Data length	16bit	Access	R/W	Address	0x 0445		
	Effective	Immediate						

You can set up the timing to feed out the Zero-speed detection output signal (ZSP or TCL) in rotate speed (r/min).

The zero-speed detection signal(ZSP) will be fed out when the motor speed falls below the setup of this parameter, Pr4.34

- The setup of pr4.34 is valid for both positive and negative direction regardless of the motor rotating direction.
- There is hysteresis of 10[r/min]

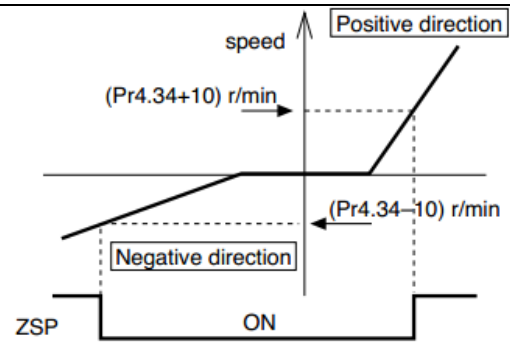

Pr4.35	Name	Speed coincidence range			Mode	V
	Range	10~2000	Unit	r/min	Default	50
	Data length	16bit	Access	R/W	Address	0x 0447
	Effective	Immediate				

Set the speed coincidence (V-COIN) output detection timing.

Output the speed coincidence (V-COIN) when the difference between the speed command and the motor speed is equal to or smaller than the speed specified by this parameter.

Because the speed coincidence detection is associated with 10 r/min hysteresis, actual detection range is as shown below.

Speed coincidence output OFF -> ON timing $(Pr4.35 - 10)$ r/min

Speed coincidence output ON -> OFF timing $(Pr4.35 + 10)$ r/min

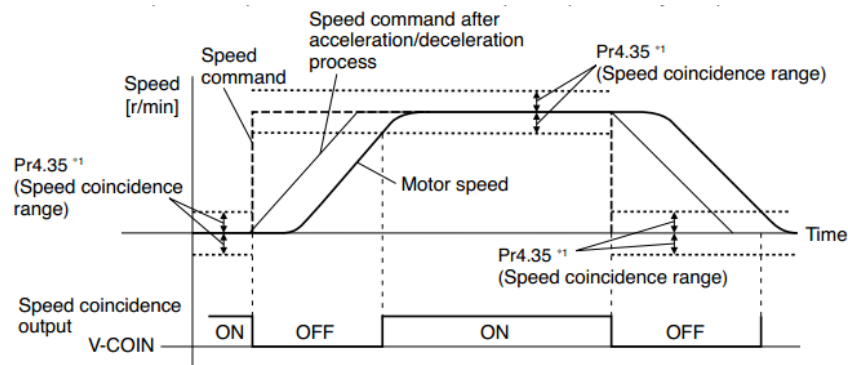

Pr4.36	Name	At-speed(Speed arrival)			Mode	V
	Range	10~2000	Unit	r/min	Default	1000
	Data length	16bit	Access	R/W	Address	0x 0449
	Effective	Immediate				

Set the detection timing of the speed arrival output (AT-SPEED).
 When the motor speed exceeds this setup value, the speed arrive output (AT-SPEED) is output.
 Detection is associated with 10r/min hysteresis.

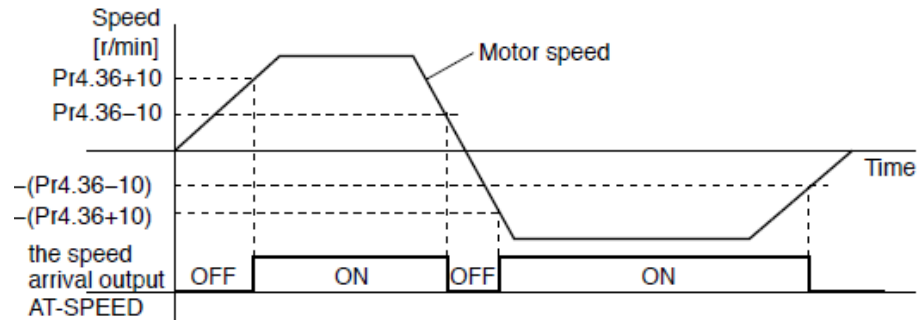

Pr4.37	Name	Mechanical brake action at stalling setup			Mode	P	V	T
	Range	0~10000	Unit	1ms	Default	0		
	Data length	16bit	Access	R/W	Address	0x 044B		
	Effective	Immediate						

Motor brake delay time setup, mainly used to prevent servo on “galloping” phenomenon.
 Set up the time from when the brake release signal(BRK-OFF) turns off to when the motor is de-energized (servo-free),when the motor turns to servo-off while the motor is at stall

- Set up to prevent a micro-travel/drop of the motor (work) due to the action delay time (t_b) of the brake.
- Ni After setting up $Pr4.37 \geq t_b$, then compose the sequence so as the drive turns to servo-off after the brake is actually activated.

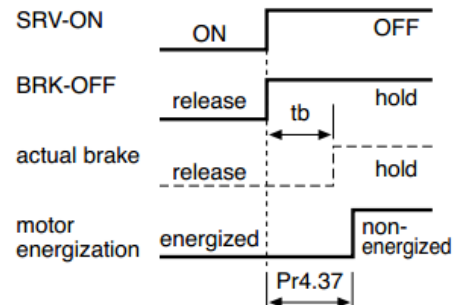

Pr4.38	Name	Mechanical brake action at running setup			Mode	P	V	T
	Range	0~10000	Unit	1ms	Default	0		
	Data length	16bit	Access	R/W	Address	0x 044D		
	Effective	Immediate						

Mechanical brake start delay time setup, mainly used to prevent servo off “galloping phenomenon”

Set up time from when detecting the off of servo-on input signal(SRV-ON)is to when external brake release signal(BRK-OFF)turns off, while the motor turns to servo off during the motor in motion

- Set up to prevent the brake deterioration due to the motor running.
- At servo-OFF during the motor is running , tb of the right fig will be a shorter one of either Pr4.38 setup time, or time lapse till the motor speed falls below Pr4.39 setup speed

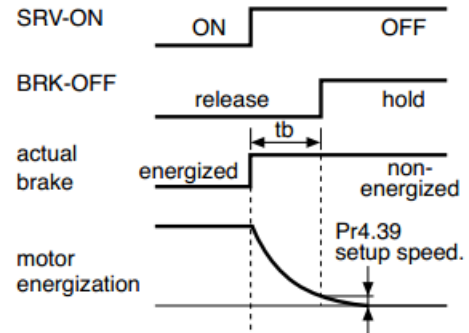

Pr4.39	Name	Brake release speed setup			Mode	P	V	T
	Range	30~3000	Unit	1ms	Default	30		
	Data length	16bit	Access	R/W	Address	0x 044F		
	Effective	Immediate						
When servo off, rotate speed less than this setup vale, and mechanical brake start delay time arrive, motor lost power.								

5.2.6 【Class 5】 Extended Setup

Pr5.00	Name	2nd Command pulse counts per one motor revolution			Mode	P		
	Range	0-8388608	Unit	p	Default	0		
	Data length	32bit	Access	R/W	Address	0x 0500 0x 0501		
	Effective	Power-on again						
Set the command pulse that causes single turn of the motor shaft. Select Pr0.08 1st or Pr5.00 2nd by IO signal. 1) If Pr5.00≠0 , the actual turns = pulse number / Pr5.00 2) If Pr5.00 = 0, Pr5.01 2nd numerator of electronic gear and Pr5.02 2nd Denominator of electronic Gear become valid.								

Pr5.01	Name	2nd numerator of electronic gear			Mode	P		
	Range	1~1073741824	Unit	—	Default	1		
	Data length	32bit	Access	R/W	Address	0x 0502 0x 0503		
	Effective	Power-on again						
Set the numerator of division/multiplication operation made according to the command pulse input								
Pr5.02	Name	2nd denominator of electronic gear			Mode	P		

	Range	1~1073741824	Unit	—	Default	1
	Data length	32bit	Access	R/W	Address	0x 0504 0x 0505
	Effective	Power-on again				
Set the denominator of division/multiplication operation made according to the command pulse input. Instructions refer to Pr0.09 and Pr0.10 and select by IO signal						

Pr5.04	Name	Over-travel inhibit input setup			Mode	P	V	T
	Range	0/1/2	Unit	1ms	Default	0		
	Data length	16bit	Access	R/W	Address	0x 0509		
	Effective	Immediate						
0: positive and negative limit effective, No. alarm output; 1: positive and negative limit effective invalid; 2: positive and negative limit effective, alarm output;								

Pr5.06	Name	Sequence at servo-off			Mode	P	V	T
	Range	0~1	Unit	—	Default	0		
	Data length	16bit	Access	R/W	Address	0x 050D		
	Effective	Immediate						
Specify the status during deceleration and after stop, after servo-off.								
		Setup Value	During Deceleration			After Stop		
		0	emergency			Free-run		
		1	Free-run			Free-run		

Pr5.08	Name	LV trip selection at main power OFF			Mode	P	V	T
	Range	0~1	Unit	—	Default	1		
	Data length	16bit	Access	R/W	Address	0x 0511		
	Effective	Immediate						
You can select whether or Not to activate Err0d.0 (main power under-voltage protection) function while the main shutoff continues for the setup of Pr5.09 (The main power-OFF detection time).								
		Setup Value	Action of Main Power Low Voltage Protection					
		0	When the main power is shut off during Servo-On, Err0d.0 will Not be triggered and the drive turns to Servo-OFF. The drive returns to Servo-On again after the main power resumption.					
		1	When the main power is shut off during Servo-On, the drive will trip due to Err0d.0					
Caution: Err0d.0 (main power under-voltage protection) is trigged when setup of Pr5.09 is long and P-N voltage of the main converter falls below the specified value before detecting the main power shutoff, regardless of the Pr5.08 setup.								

Pr5.09 *	Name	The main power-OFF detection time	Mode	P	V	T
-----------------	------	-----------------------------------	------	----------	----------	----------

	Range	70~2000	Unit	1ms	Default	70
	Data length	16bit	Access	R/W	Address	0x 0513
	Effective	Power-on again				

You can set up the time to detect the shutoff while the main power is kept shut off continuously. The main power off detection is invalid when you set up this to 2000.

Pr5.10	Name	Dynamic braking mode			Mode	P V T
	Range	0~2	Unit		Default	0
	Data length	16bit	Access	R/W	Address	0x 0515
	Effective	Power-on again				

0: Dynamic braking is valid in both Normal and abnormal conditions.

1: Dynamic braking is valid in Normal condition, invalid in abnormal condition. (used to prevent abnormal conditions, high speed and large inertia to burn up the dynamic braking)

2: Dynamic braking is invalid in both Normal and abnormal conditions.

Pr5.11 *	Name	Torque setup for emergency stop			Mode	P V T
	Range	0~500	Unit	%	Default	0
	Data length	16bit	Access	R/W	Address	0x 0517
	Effective	Immediate				

Set up the torque limit at emergency stop

When setup value is 0, the torque limit for Normal operation is applied.

Pr5.12	Name	Over-load level setup			Mode	P V T
	Range	0~115	Unit	%	Default	0
	Data length	16bit	Access	R/W	Address	0x 0519
	Effective	Immediate				

You can set up over-load level. The overload level becomes 115% by setting up this value to 0.

Use this with 0 setup in Normal operation, set up other value only when you need to low this over-load level.

The setup value of this parameter is limited by 115% of the motor rating.

Pr5.13	Name	Over-speed level setup			Mode	P V T
	Range	0~10000	Unit	r/min	Default	0
	Data length	16bit	Access	R/W	Address	0x 051B
	Effective	Immediate				

If the motor speed exceeds this setup value, Err1A.0 [over-speed protect] occurs.

The over-speed level becomes 1.2 times of the motor max. speed by setting up this to 0.

Pr5.15 *	Name	I/F reading filter			Mode	P	V	T
	Range	0~255	Unit	0.1ms	Default	0		
	Data length	16bit	Access	R/W	Address	0x 051F		
	Effective	Power-on again						
I/O input digital filtering; higher setup will initiate control delay.								

Pr5.17	Name	Counter clear input mode			Mode	P		
	Range	0~4	Unit	—	Default	3		
	Data length	16bit	Access	R/W	Address	0x 0523		
	Effective	Immediate						
Set up the clearing conditions of the counter clear input signal								
		Setup Value		Clear Condition				
		0/2/4		Invalid				
		1		Always clear				
		3		Only clear one time				

Pr5.20	Name	Position setup unit select			Mode	P		
	Range	0~2	Unit	—	Default	2		
	Data length	16bit	Access	R/W	Address	0x 0529		
	Effective	Immediate						
Specify the unit to determine the range of positioning complete and excessive positional deviation								
		Setup Value		Unit				
		0		Encoder unit				
		1		Command unit				
		2		10000pulse/rotation				

Pr5.21	Name	Selection of torque limit			Mode	P	V	T
	Range	0~5	Unit	—	Default	0		
	Data length	16bit	Access	R/W	Address	0x 052B		
	Effective	Immediate						
Set up the torque limiting method								
		Setup Value		Limiting Value				
		0		Pr0.13				
		1		Pr5.22				
2	TL-SEL off		Pr0.13					
	TL-SEL on		Pr5.22					
		5		Pr0.13 Positive torque limit Pr5.22 Negative torque limit				

Pr5.22	Name	2nd torque limit			Mode	P	V	T
	Range	0~500	Unit	%	Default	300		

	Data length	16bit	Access	R/W	Address	0x 052D
	Effective	Immediate				
Set up the 2nd limit value of the motor torque output The value of the parameter is limited to the maximum torque of the applicable motor.						

Pr5.23	Name	Positive torque reached			Mode	P	V	T
	Range	0~300	Unit	%	Default	0		
	Data length	16bit	Access	R/W	Address	0x 052F		
	Effective	Immediate						
<ul style="list-style-type: none"> ● Default setting is 0, if the torque feedback is greater than 95% of the rated torque, output TCL signal. ● If the torque feedback is greater than the user setting value, output TCL signal. 								

Pr5.24	Name	Negative torque reached			Mode	P	V	T
	Range	0~300	Unit	%	Default	0		
	Data length	16bit	Access	R/W	Address	0x 0531		
	Effective	Immediate						
<ul style="list-style-type: none"> ● Default setting is 0, if the torque feedback is greater than 95% of the rated torque, output TCL signal. ● If the torque feedback is greater than the user setting value, output TCL signal. 								

Pr5.28 *	Name	LED initial status			Mode	P	V	T
	Range	0~35	Unit	—	Default	1		
	Data length	16bit	Access	R/W	Address	0x 0539		
	Effective	Immediate						

You can select the type of data to be displayed on the front panel LED (7-segment) at the initial status after power-on.

Setup Value	Content	Setup Value	Content	Setup Value	Content
0	Positional command deviation	10	I/O signal status	27	Voltage across PN [V]
1	Motor speed	11	Analog input value	28	Software version
2	Positional command speed	12	Error factor and reference of history	29	Drive serial number
3	Velocity control command	16	Inertia ratio	30	Motor serial number
4	Torque command	17	Factor of No.-motor running	31	Accumulated operation time
5	Feedback pulse sum	23	Communication axis address	33	Temperature information
6	Command pulse sum	24	Encoder positional deviation [encoder unit]	36	Safety condition monitor
9	Control mode				

Pr5.29 *	Name	Mode setup of Modbus communication			Mode	P	V	T
	Range	0~255	Unit	—	Default	5		
	Data length	16bit	Access	R/W	Address	0x 053B		
	Effective	Immediate						
	Value	Data Bit	Parity-Check		Stop Bit			
	0	8	Even Parity		2			
	1	8	Odd Parity		2			
	2	8	Even Parity		1			
	3	8	Odd Parity		1			
	4	8	None		1			
	5	8	None		2			

Pr5.30 *	Name	Baud rate setup of Modbus communication			Mode	P	V	T
	Range	0~6	Unit	—	Default	2		
	Data length	16bit	Access	R/W	Address	0x 053D		
	Effective	Immediate						
Set up the communication baud rate of RS485.								
	Setup Value	Baud Rate	Setup Value	Baud Rate				
	0	2400bps	4	38400bps				
	1	4800bps	5	57600bps				
	2	9600bps	6	115200bps				
	3	19200bps						

Pr5.31 *	Name	Modbus slave axis ID			Mode	P	V	T
	Range	0~127	Unit	—	Default	1		
	Data length	16bit	Access	R/W	Address	0x 053F		
	Effective	Immediate						
During communication with the host (e.g. PC) to control multiple shafts, the shaft being accessed by the host should be identified. Note: when using RS232/RS485, the maximum valid value is 31.								

Pr5.32	Name	Command pulse input maximum setup			Mode	P		
	Range	0~4000	Unit	KHZ	Default	0		
	Data length	16bit	Access	R/W	Address	0x 0541		
	Effective	Immediate						
Set the maximum number of pulses to be used as command pulse input, if the number of the input pulse exceeds the setup value ,ERR1B0 command pulse input frequency error protection occurs								

Pr5.35 *	Name	Front panel lock setup			Mode	P	V	T						
	Range	0~1	Unit	—	Default	0								
	Data length	16bit	Access	R/W	Address	0x 0547								
	Effective	Immediate												
Lock the operation on the front panel. <table border="1" style="width: 100%; margin-top: 5px;"> <thead> <tr> <th style="width: 20%;">Setup Value</th> <th>Content</th> </tr> </thead> <tbody> <tr> <td style="text-align: center;">0</td> <td>No. limit on the front panel operation</td> </tr> <tr> <td style="text-align: center;">1</td> <td>Lock the operation on the front panel</td> </tr> </tbody> </table>									Setup Value	Content	0	No. limit on the front panel operation	1	Lock the operation on the front panel
Setup Value	Content													
0	No. limit on the front panel operation													
1	Lock the operation on the front panel													

Pr5.36	Name	7 th setting parameters open			Mode	P	V	T						
	Range	0, 102	Unit	—	Default	0								
	Data length	16bit	Access	R/W	Address	0x 0549								
	Effective	Immediate												
7 th setting parameters open. <table border="1" style="width: 100%; margin-top: 5px;"> <thead> <tr> <th style="width: 20%;">Setup Value</th> <th>Content</th> </tr> </thead> <tbody> <tr> <td style="text-align: center;">0</td> <td></td> </tr> <tr> <td style="text-align: center;">102</td> <td>Open 7th setting parameters modification authority.</td> </tr> </tbody> </table>									Setup Value	Content	0		102	Open 7 th setting parameters modification authority.
Setup Value	Content													
0														
102	Open 7 th setting parameters modification authority.													

5.2.7 【Class 6】 Special Setup

Pr6.03	Name	JOG trial run command torque			Mode			T
	Range	0~100	Unit	%	Default	0		

	Data length	16bit	Access	R/W	Address	0x 0607
	Effective	Immediate				
You can set up the command speed used for JOG trial run (torque control).						

Pr6.04	Name	JOG trial run command speed			Mode	P	V	T
	Range	0~10000	Unit	r/min	Default	300		
	Data length	16bit	Access	R/W	Address	0x 0609		
	Effective	Immediate						
You can set up the command speed used for JOG trial run (velocity control).								

Pr6.05	Name	Position 3 rd gain valid time			Mode	P		
	Range	0~1000	Unit	0.1ms	Default	0		
	Data length	16bit	Access	R/W	Address	0x 060B		
	Effective	Immediate						
Set up the time at which 3 rd gain becomes valid. When Not using this parameter, set Pr6.05=0, Pr6.06=100 This is valid for only position control/full-closed control.								

Pr6.06	Name	Position 3 rd gain multiplication			Mode	P		
	Range	0~1000	Unit	100%	Default	0		
	Data length	16bit	Access	R/W	Address	0x 060D		
	Effective	Immediate						
Set up the 3 rd gain by multiplying factor of the 1 st gain 3rd gain= 1st gain * Pr6.06/100.								

Pr6.07	Name	Torque command additional value			Mode	P	V	T
	Range	-100~100	Unit	%	Default	0		
	Data length	16bit	Access	R/W	Address	0x 060F		
	Effective	Immediate						
Pr6.08	Name	Positive torque compensation value			Mode	P	V	T
	Range	-100~100	Unit	%	Default	0		
	Data length	16bit	Access	R/W	Address	0x 0611		
	Effective	Immediate						
Pr6.09	Name	Negative torque compensation value			Mode	P	V	T
	Range	-100~100	Unit	%	Default	0		
	Data length	16bit	Access	R/W	Address	0x 0613		
	Effective	Immediate						
These three parameters may apply feed forward torque superposition directly to torque								

command.

Pr6.10	Name	Function extension			Mode	P		
	Range	0x0~0xFFFF	Unit	—	Default	0x0		
	Data length	16bit	Access	R/W	Address	0x0615		
	Effective	Power-on again						

Pr6.10 is only valid in position control mode and Pr0.07=3.

Value	Bit set	Function
0x0	bit1=0, bit2=0	Pulse and direction input polarity do not change
0x2	bit1=1, bit2=0	Pulse input polarity is reversed
0x4	bit1=0, bit2=1	Direction input polarity is reversed
0x6	bit1=1, bit2=1	Pulse and direction input polarity are reversed

Note:

Only bit1 and bit2 are supported for setting, please do not change other bits.

Pr6.11	Name	Current response setup			Mode	P	V	T
	Range	50~100	Unit	%	Default	100		
	Data length	16bit	Access	R/W	Address	0x0617		
	Effective	Immediate						

Set the value ratio of the drive current loop parameters.

Pr6.14	Name	Emergency stop time at alarm			Mode	P	V	T
	Range	0~3000	Unit	ms	Default	200		
	Data length	16bit	Access	R/W	Address	0x 061D		
	Effective	Immediate						

Set up the time allowed to complete emergency stop in an alarm condition, exceeding this time puts this system in alarm state.

Pr6.20	Name	Trial run distance			Mode	P		
	Range	0~1200	Unit	0.1rev	Default	10		
	Data length	16bit	Access	R/W	Address	0x 0629		
	Effective	Immediate						

The distance of running each time in JOG run(position control)

Pr6.21	Name	Trial run waiting time			Mode	P		
	Range	0~30000	Unit	Ms	Default	100		
	Data length	16bit	Access	R/W	Address	0x 062B		

	Effective	Immediate				
The waiting time after running each time in JOG run(position control)						

Pr6.22	Name	Trial run cycle times			Mode	P	
	Range	0~32767	Unit	—	Default	5	
	Data length	16bit	Access	R/W	Address	0x 062D	
	Effective	Immediate					
The cycling times of JOG run(position control)							

Pr6.25	Name	Acceleration of trial running			Mode	P	V
	Range	0~32767	Unit	ms	Default	100	
	Data length	16bit	Access	R/W	Address	0x 0633	
	Effective	Immediate					
Acceleration time from 0rpm~1000rpm of trial running							

Pr6.27	Name	Warning latching time setup			Mode	P	V
	Range	0~10	Unit	ms	Default	0	
	Data length	16bit	Access	R/W	Address	0x0637	
	Effective	Immediate					
0: Standard model 1: Mode 1, under study							

Pr6.28	Name	Observer gain			Mode	P	V
	Range	0~32767	Unit	%	Default	0	
	Data length	16bit	Access	R/W	Address	0x0639	
	Effective	Immediate					
0: Default gain 1: Off x: Unit: %, manual, dependent on motor, load and encoder							

Pr6.29	Name	Observer filter			Mode	P	V
	Range	0~32767	Unit	us	Default	0	
	Data length	16bit	Access	R/W	Address	0x063B	
	Effective	Immediate					
0: Default gain 1: Off x: Unit: %, manual, dependent on motor, load and encoder							

Pr6.56	Name	Motor blocking alarm torque threshold			Mode	P	V
	Range	0~300	Unit	%	Default	300	
	Data length	16bit	Access	R/W	Address	0x0661	

Effective	Immediate				
Value=0: Motor blocking alarm function off. Value≠0: Function on. Set the motor blocking alarm torque threshold (Motor speed is equal or lesser than 20 rpm) If the motor reaches this torque threshold when motor speed is greater than 20rpm, it will not trigger the motor blocking alarm Er102.					

Pr6.57	Name	Motor blocking alarm delay time			Mode	P	V	
	Range	1~10000	Unit	ms	Default	400		
	Data length	16bit	Access	R/W	Address	0x0663		
	Effective	Immediate						

Pr6.57 is effective if Pr6.56≠0.

For example:

Pr6.56=300, Pr6.57=400; motor blocking speed threshold default is 20rpm

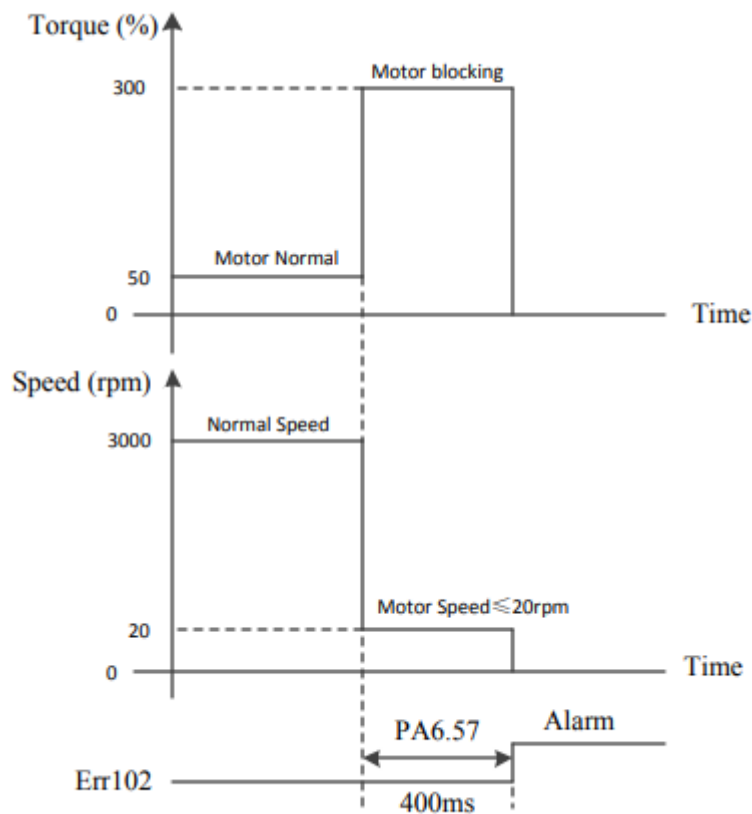

-If the Pr0.13 torque limit is lesser than the blocking torque threshold, the overload alarm Er100 will occur when the motor load is too large.

-If the speed is greater than 20rpm when blocking, it will not trigger the motor blocking alarm Er102, but will trigger the alarm Er100.

Pr6.63	Name	Absolute multi-turn position upper bound			Mode	P	V	T
	Range	0~32766	Unit	Rotation	Default	0		

	Data length	16bit	Access	R/W	Address	0x 067F
	Effective	Power-on again				
While Pr0.15=2: Absolute position rotation mode: The encoder is used as an absolute encoder, and the position retentive at power failure is supported.. It is mainly applicable to the scenario where the load travel range is Not limited and the number of motor single-direction revolution is less than 0~(Pr6.63+1)						

5.2.8 【Class B】 Status Information

Note: This parameters class is only for RS485 communication.

PrB.00	Name	Software version 1 (DSP)			Mode	P	V	T
	Range		Unit		Default			
	Data length	16bit	Access	R	Address	0x 0B00		
Display Software version 1 (DSP)								

PrB.01	Name	Software version 2 (CPLD)			Mode	P	V	T
	Range		Unit		Default			
	Data length	16bit	Access	R	Address	0x 0B01		
Display Software version 2 (CPLD)								

PrB.02	Name	Software version 3 (other)			Mode	P	V	T
	Range		Unit		Default			
	Data length	16bit	Access	R	Address	0x 0B02		
Display Software version 3								

PrB.03	Name	Error code			Mode	P	V	T
	Range		Unit		Default			
	Data length	16bit	Access	R	Address	0x 0B03		
Display Error code								

PrB.04	Name	Factor of No.-motor running			Mode	P	V	T
	Range		Unit		Default			
	Data length	16bit	Access	R	Address	0x 0B04		
Factor of No.-motor running								

PrB.05	Name	Drive operating state			Mode	P	V	T
	Range		Unit		Default			
	Data length	16bit	Access	R	Address	0x 0B05		
	Bit	Function	Details					
	0	RDY	Servo ready					
	1	RUN	Servo run					
	2	ERR	Servo error					
	3	HOME_OK	Homing process finished					
	4	INP	Positioning complete					
	5	AT-SPEED	At-speed					
	6~15		Reserve					

PrB.06	Name	Actual velocity (unfiltered)			Mode	P	V	T
	Range		Unit	RPM	Default			
	Data length	16bit	Access	R	Address	0x 0B06		
Actual velocity (unfiltered)								

PrB.07	Name	Actual torque feedback			Mode	P	V	T
	Range		Unit	%	Default			
	Data length	16bit	Access	R	Address	0x 0B07		
Actual torque feedback (Percentage of the rated torque)								

PrB.08	Name	Actual current feedback			Mode	P	V	T
	Range		Unit	0.01A	Default			
	Data length	16bit	Access	R	Address	0x 0B08		
Actual current feedback								

PrB.09	Name	Actual velocity(After filtering)			Mode	P	V	T
	Range		Unit	RPM	Default			
	Data length	16bit	Access	R	Address	0x 0B09		
Actual velocity(After filtering)								

PrB.10	Name	DC bus voltage			Mode	P	V	T
	Range		Unit	V	Default			
	Data length	16bit	Access	R	Address	0x 0B0A		
DC bus voltage								

PrB.11	Name	Drive temperature			Mode	P	V	T
	Range		Unit	°C	Default			
	Data length	16bit	Access	R	Address	0x 0B0B		
Drive temperature								

PrB.12	Name	Analog input1			Mode	P	V	T
	Range		Unit	0.01V	Default			
	Data length	16bit	Access	R	Address	0x 0B0C		
Analog input1								

PrB.13	Name	Analog input 2			Mode	P	V	T
	Range		Unit	0.01V	Default			
	Data length	16bit	Access	R	Address	0x 0B0D		
Analog input2								

PrB.14	Name	Analog input 3			Mode	P	V	T
	Range		Unit	0.01V	Default			
	Data length	16bit	Access	R	Address	0x 0B0E		
Analog input3								

PrB.15	Name	Over-load ratio			Mode	P	V	T
	Range		Unit	%	Default			
	Data length	16bit	Access	R	Address	0x 0B0F		
Over-load ratio (%)								

PrB.16	Name	Regeneration load ratio			Mode	P	V	T
	Range		Unit	%	Default			
	Data length	16bit	Access	R	Address	0x 0B10		
Regeneration load ratio (%)								

PrB.17	Name	Digital input signal status			Mode	P	V	T
	Range		Unit		Default			
	Data length	16bit	Access	R	Address	0x 0B11		
Digital input signal status:								
			Bit	SI Input				

	0	SI1
	1	SI2
	2	SI3

	8	SI9

Bitn=1, indicates SI (n+1) is at high level; Bitn=0, indicates SI (n+1) is at low level.

PrB.18	Name	Digital output signal status			Mode	P	V	T
	Range		Unit		Default			
	Data length	16bit	Access	R	Address	0x 0B11		

Digital output signal status:

Bit	SO Output
0	SO1
1	SO2
2	SO3
...	...
5	SO6

Bitn=1, indicates SO (n+1) is at high level; Bitn=0, indicates SO (n+1) is at low level.

PrB.20	Name	Motor position feedback (command unit)			Mode	P		
	Range		Unit	P	Default			
	Data length	32bit	Access	R	Address	0x 0B14 0x 0B15		

Motor position feedback (Command unit) .

If the drive receives 8388608 pulse, and the drive's instruction unit is 10000pulse/ r, the encoder unit is 8388608 pulse/r, then the drive motor position feedback pulse number is 10000P

PrB.21	Name	Command pulse sum (command unit)			Mode	P		
	Range		Unit	P	Default			
	Data length	32bit	Access	R	Address	0x 0B16 0x 0B17		

Command pulse sum (Command unit)

PrB.22	Name	Positional deviation (command unit)			Mode	P		
	Range		Unit	p	Default			
	Data length	32bit	Access	R	Address	0x 0B18 0x 0B19		

Positional deviation (Command unit) ,refer to PrB.23 for details.

PrB.23	Name	Position command (encoder unit)			Mode	P		
	Range		Unit		Default			
	Data length	32bit	Access	R	Address	0x 0B1A 0x 0B1B		
Position command (Encoder unit) If the drive's instruction unit is 10000pulse/ r, the encoder unit is 8388608 pulse/r, then the drive receive 10000pulse, the position command pulse number is 8388608 pulse								

PrB.24	Name	Motor position (encoder unit)			Mode	P		
	Range		Unit		Default			
	Data length	32bit	Access	R	Address	0x 0B1C 0x 0B1D		
Motor position (encoder unit)								

PrB.25	Name	Positional deviation(encoder unit)			Mode	P		
	Range		Unit		Default			
	Data length	32bit	Access	R	Address	0x 0B1E 0x 0B1F		
Positional deviation(encoder unit)								

PrB.26	Name	Position feedback in rotation mode(encoder unit)			Mode	P		
	Range		Unit		Default			
	Data length	32bit	Access	R	Address	0x 0B20H 0x 0B21		
Position feedback in rotation mode(encoder unit), refer to PrB.23 for details.								

Chapter 6 Alarm and Processing

6.1 Alarm List

Protection function is activated when an error occurs, the drive will stop the rotation of servo motor, and the front panel will automatically display the corresponding fault error code. The history of the error can be viewed on data monitoring mode. Error logging submenu displays like: “d12er”.

Table 6.1 Error Code List

Error Code		Content	Attribute		
Main	Sub		Save	Emergency Stop	Available to Clear
09	0~F	FPGA communication error	●		
0A	0~1	Current detection circuit error	●		
	2. 4	Analog input circuit error	●		
	3	Power line (U/V/W) not connected	●		
	5	DC bus circuit error	●		
	6	Temperature detection circuit error	●		
0b	0	Control power under-voltage	●		
0c	0	DC bus over-voltage	●		●
0d	0	DC bus under-voltage	●		●
	2	Power line (U/V/W) not connected			●
0E	0	Over-current	●		
	1	over-current of intelligent power module (IPM)	●		
0F	0	Drive over-heat	●	●	
10	0	Motor over-load	●		●
	1	Drive over-load	●		●
12	0	Resistor discharged circuit overload	●	●	
	1	Brake error	●		
15	0	Encoder wiring error	●		
	1	Encoder data error	●		
	2	Encoder initial position error	●		
	3	Encoder battery low-voltage error	●		●
17	0	Encoder data error	●	●	
	1	Motor parameter error			
18	0	Too large position pulse deviation	●	●	●
	1	Too large velocity deviation	●	●	●
19	0	Vibration is too large	●	●	●
1A	0	Over-speed 1	●	●	●
	1	Speed out of control	●		●
21	0	I/F input interface allocation error	●		●
	1	I/F input interface function set error	●		●
	2	I/F output interface function set error	●		●
24	0	CRC verification error when EEPROM			

		parameter saved			
26	0	Positive/negative over-range input valid	•	•	•
57	0	Compulsory alarm input valid	•	•	

Save: Save the error history record.

Emergency stop: drive will stop immediately when alarm occurs.

Available to clear: Alarm is available to be removed through SI input/panel/configuration software.

Table 6.2 Relation between Alarm Code and 603Fh

Alarm Code	1001h Object	603Fh Object	ETG Code	Alarm Specification
Er 0A0	0x04	0x3150		Current detection circuit error of phase A
Er 0A1	0x04	0x3151		Current detection circuit error of phase B
Er 0A3	0x04	0x3153		U/V/W wire disconnection error
Er 0C0	0x04	0x3211		Over-voltage of DC bus
Er 0d0	0x04	0x3221		Under-voltage of DC bus
Er 0d2	0x04	0x3222		Lack of supply power
Er 0E0	0x02	0x2211		Over-current
Er 0E1	0x02	0x2212		Over-current of IPM
Er 0f0	0x08	0x4210		Over-heat of drive
Er 100	0x02	0x8310		Over-load
Er 101	0x02	0x8311		Over-load
Er 120	0x80	0x7701		Discharge overload
Er 150	0x80	0x7321		Encoder disconnection
Er 151	0x80	0x7322		Encoder communication error
Er 152	0x80	0x7323		Initial position error of encoder
Er 153/ Er 154	0x80	0x7325		Low-voltage error of battery of absolute encoder Parameter error of encoder mode
Er 155	0x80	0x7326		Data exceeding of absolute multi-turn encoder
Er 156	0x80	0x7327		Over-heat of encoder
Er 157	0x80	0x7328		Encoder count error
Er 170	0x80	0x7324		Encoder data error
Er 180	0x20	0x 8611		Position overproof
Er 190	0x20	0x 8401		Alarm of excessive vibration
Er 1A0	0x20	0x 8402		Over-speed
Er 1a1	0x20	0x 8403		Speed out of control
Er 1b0	0x20	0x 8612		Over-frequency of position command
Er 1b1	0x20	0x 8503		Electronic gear ratio error
Er 210	0x80	0x6321		Repeat error of input I/O parameters
Er 211	0x80	0x6322		Over-range of input I/O parameters
Er 212	0x80	0x6323		Over-range of output I/O parameters
Er 240	0x80	0x5530		Saving error of parameters
Er 241	0x80	0x5531		EEPROM hardware error
Er 242	0x80	0x5532		Saving error of alarm history

Er 243	0x80	0x5533		Saving error of manufacturer parameters
Er 244	0x80	0x5534		Saving error of communication parameters
Er 245	0x80	0x5535		Saving error of 402 parameters
Er 246	0x80	0x5536		Saving error of power off data
Er 260	0x80	0x7329		Limit alarm, valid while selecting alarm on limit function
Er 570	0x80	0x5441		IO emergency stop
Er 5f0	0x80	0x7122		Wrong motor model
Er 73A	0x10	0x873A		Over-loss of SM2
Er 73b	0x10	0x873B		Over-loss of Sync0
Er 73c	0x10	0x873C		Excessive DC error
Er 801	0x10	0x8201	0x0001	Unknown communication error
Er 802	0x80	0x5510	0x0002	Inadequate RAM
Er 803	0x80	0x5511		RAM cross the border
Er 805	0x80	0x6202		Fail to upgrade FOE firmware
Er 806	0x80	0x6201		Mismatching between saved ESI files and drive firmware
Er 811	0x10	0xA001	0x0011	Invalid ESM status transfer
Er 812	0x10	0xA002	0x0012	Unknown ESM transfer request
Er 813	0x10	0x8213	0x0013	Not support BOOT
Er 814	0x80	0x6203		Invalid firmware
Er 815	0x10	0x8215	0x0015	Invalid configuration on BOOT mode
Er 816	0x10	0x8216	0x0016	Invalid Preop configuration
Er 817	0x10	0x8217		Invalid SM configuration
Er 818	0x10	0x8211		Invalid input data
Er 819	0x10	0x8212		Invalid output data
Er 81A	0x10	0xFF02	0x871A	Sync loss error
Er 81b	0x10	0x821B	0x001B	SM watchdog timeout
Er 81C	0x10	0x821C	0x001C	Invalid SM type
Er 81d	0x10	0x821D	0x001D	Invalid output configuration
Er 81E	0x10	0x821E	0x001E	Invalid input configuration
Er 81f	0x10	0x821F		Invalid watchdog configuration
Er 821	0x10	0xA003	0x0021	Slave station waiting for initial-operational request
Er 822	0x10	0xA004	0x0022	Slave station waiting for pre-operational request
Er 823	0x10	0xA005	0x0023	Slave station waiting for safe-operational request
Er 824	0x10	0x8224	0x0024	Invalid TPDO mapping
Er 825	0x10	0x8225	0x0025	Invalid RPDO mapping
Er 827	0x10	0x8227		Not support free-move mode
Er 828	0x10	0x8228		Not support synchronous mode

Er 82b	0x10	0x8210	0x002B	Configuration not same
Er 82C	0x10	0x872C	0x002C	Synchronous error
Er 82d	0x10	0x872D	0x002D	No synchronous error (pre-op to safe-op not receive synchronous command from master station)
Er 82E	0x10	0x872E	0x002E	Synchronous cycle too small
Er 830	0x10	0x8730	0x0030	Invalid DC configuration
Er 832	0x10	0x8732	0x0032	DC PLL error
Er 833	0x10	0x8733		Synchronous error between DC to IO
Er 834	0x10	0x8734		DC Synchronous over-time
Er 835	0x10	0x8735		Invalid DC cycle
Er 836	0x10	0x8736	0x0036	Invalid sync0 cycle
Er 850	0x80	0x5550	0x0050	No access to ESC EEPROM
Er 851	0x80	0x5551	0x0051	Saving error of ESI files
Er 852	0x80	0x5552	0x0052	Fail to build link
Er 860	0x80	0xFF01		Over-loss of ECAT frame loss per unit time
Er 870	0x80	0x5201		Not support drive enable while operating

6.2 Alarm Processing Method

When appear error, please clear error reason, renew power on

Error code	Main	Extra	Display: “Er 090”--“Er 09F”	
	09	0~F	Content: FPGA communication error	
Cause			Confirmation	Solution
L1,L2 terminal under-voltage			Check L1,L2 terminal voltage	Make sure voltage of L1,L2 terminal in proper range;
Drive internal fault			/	Replace the drive with a new one;

Error code	Main	Extra	Display: “Er 0A0”--“Er 0A1”	
	0A	0~1	Content: Current detection circuit error	
Cause			Confirmation	Solution
Wiring error of motor output U,V,W terminal			Check wiring of motor output U,V,W terminal	Make sure motor U,V,W terminal wiring correctly;
Main voltage L1,L2,L3 terminal voltage whether over-low			Check main voltage L1,L2,L3 terminal voltage	Make sure voltage of L1,L2,L3 terminal in proper range; Replace the drive with a new one;
Drive inner fault			/	Tune cable and power cable work at same time, pluck out tune cable;

Error code	Main	Extra	Display: “Er 0A2”, “Er 0A4”	
	0A	2, 4	Content: Analog input circuit error	
Cause			Confirmation	Solution

Analog input Wiring error	Check wiring of analog input	Make sure analog input wiring correctly; Replace the drive with a new one;
Drive inner fault	/	

Error code	Main	Extra	Display: “Er 0A3”	
	0A	3	Content: Power line (U/V/W) not connected	
Cause			Confirmation	Solution
Power line (U/V/W) not connected			Check wiring of U/V/W	Make sure UVW wiring correctly; Replace the motor with a new one;
Motor inner fault			/	

Error code	Main	Extra	Display: “Er 0A5”	
	0A	5	Content: DC bus circuit error	
Cause			Confirmation	Solution
Main voltage L1,L2,L3 terminal under-voltage			Check L1,L2,L3 terminal voltage	Make sure voltage of L1,L2,L3 terminal in proper range; Replace the drive with a new one;
Drive inner fault			/	

Error code	Main	Extra	Display: “Er 0A6”	
	0A	6	Content: Temperature detection circuit error	
Cause			Confirmation	Solution
L1,L2,L3 terminal under-voltage			Check L1,L2,L3 terminal voltage	Make sure voltage of L1,L2,L3 terminal in proper range; Replace the drive with a new one;
Drive inner fault			/	

Error code	Main	Extra	Display: “Er 0b0”	
	0b	0	Content: Control power under-voltage	
Cause			Confirmation	Solution
L1,L2,L3 terminal under-voltage			Check L1,L2,L3 terminal voltage	Make sure voltage of L1,L2,L3 terminal in proper range; Replace the drive with a new one;
Drive inner fault			/	

Error code	Main	Extra	Display: “Er 0c0”	
	0c	0	Content: DC bus over-voltage	
Cause			Confirmation	Solution
Main power L1,L2,L3 terminal over-voltage			Check L1,L2,L3 terminal voltage	Decrease L1,L2,L3 terminal Voltage; Keep UVW and PE cable in proper space;
Short circuit of UVW and PE cable				
Inner brake circuit damaged			/	Restore factory default;
Drive inner fault			/	Replace the drive with a new one;

Error code	Main	Extra	Display: “Er 0d0”	
	0d	0	Content: DC bus under-voltage	
Cause			Confirmation	Solution

Main power L1,L2,L3 terminal under-voltage	Check L1,L2,L3 terminal voltage	Input voltage is too large; Short circuit between cable U/V/W and cable PE; Restore factory default; Replace the drive with a new one;
Drive inner fault	/	

Error code	Main	Extra	Display: “Er 0d2”
	0d	2	Content: Lack of supply power
Cause		Confirmation	Solution
No input supply power		Check L1,L2,L3 terminal voltage	Increase L1,L2 terminal voltage;
Drive inner fault		/	Replace the drive with a new one;

Error code	Main	Extra	Display: “Er 0E0”
	0E	0	Content: Over-current
Cause		Confirmation	Solution
Short of drive output wire		Short of drive output wire, whether short circuit to pg ground or not	Ensure drive output wire no short circuit, ensure motor no. Damage; Adjust motor wiring sequence; Replace the drive with a new one; Adjust parameter to proper range; Adjust control command: open filter function;
Abnormal wiring of motor		Check motor wiring order	
Short of igbt module		Cut off drive output wiring, initiate “srv_on” and drive motor, check whether over-current exists	
Abnormal setting of control parameter		Modify the parameter	
Abnormal setting of control command		Check control command whether command changes too violently or not	

Error code	Main	Extra	Display: “Er 0E1”
	0E	1	Content: IPM over-current
Cause		Confirmation	Solution
Short of Drive output wire		Short of drive output wire, whether short circuit to PG ground or not	Ensure drive output wire no short circuit, ensure motor no damage; Adjust motor wiring sequence; Replace the drive with a new one; Adjust parameter to proper range; Adjust control command: open filter function;
Abnormal wiring of motor		Check motor wiring order	
Short of IGBT module		Cut off drive output wiring, initiate “srv_on” and drive motor, check whether over-current exists	
Short of IGBT module		/	
Abnormal setting of control parameter		Modify the parameter	
Abnormal setting of control command		Check control command whether command changes too violently or not	

Error code	Main	Extra	Display: “Er 0F0”
	0F	0	Content: Drive over-heat
Cause		Confirmation	Solution
The temperature of power module have exceeded upper limit		Check drive radiator whether the temperature is too high or not	Strengthen cooling conditions, promote the capacity of drive and motor, enlarge acceleration/deceleration time, reduce load

Error code	Main	Extra	Display: “Er 100”
	10	0	Content: Motor over-load
Cause		Confirmation	Solution
Load is too heavy		Check actual load if the value of parameter exceed maximum or not	Decrease load, adjust limit parameter; Modify the parameter of control loop; enlarge acceleration/deceleration time; Adjust wiring or replace encoder/motor for a new one; Cut off brake;
Motor over-current		Check d04 and d15;	
Oscillation of machine		Check the machine if oscillation exists or not	
Wiring error of motor		Check wiring if error occurs or not, if line breaks or not	
Electromagnetic brake engaged		Check brake terminal voltage	

Error code	Main	Extra	Display: “Er 101”
	10	1	Content: Drive over-load
Cause		Confirmation	Solution
Wiring error of motor power line		Check u/v/w wiring if error occurs or not, if line breaks or not	Check u/v/w wiring if error occurs or not, if line breaks or not; Motor current exceed drive current;
Motor doesn't match the Drive		Drive over-current	

Error code	Main	Extra	Display: “Er 102”
	10	2	Content: Motor blocked
Cause		Confirmation	Solution
Motor is blocked		Check if motor is blocked mechanically	Remove the stuff blocking motor; Increase the parameters of Pr6.56 and Pr6.57(available for software version above 113); Set Pr6.56 to 0 to turn off alarm(available for software version above 114);

Error code	Main	Extra	Display: “Er 120”
	12	0	Content: Resistance discharge circuit over-load
Cause		Confirmation	Solution
Regenerative energy has exceeded the capacity of regenerative resistor.		Check the speed if it is too high. Check the load if it is too large or not.	Lower motor rotational speed; decrease load inertia ,increase external regenerative resistor, improve the capacity of the drive and motor; increase external regenerative resistor, replace the drive with a new one;
Resistance discharge circuit damage		/	

Error code	Main	Extra	Display: “Er 121”
	12	1	Content: Braking error
Cause		Confirmation	Solution
Braking circuit damage		Braking resistor short circuit Braking IGBT damaged	Change a new braking resistor; Repair IGBT;

Error code	Main	Extra	Display: “Er 150”
	15	0	Content: Encoder line braked

Cause		Confirmation	Solution
Encoder line disconnected		Check wiring if it steady or not	Make encoder wiring steady; Reconnect encoder wiring; Replace the motor with a new one;
Encoder wiring error		Check encoder wiring if it is correct or not	
Encoder damaged		/	
Encoder measuring circuit damaged		/	
Error code	Main	Extra	Display: "Er 151"
	15	1	Content: Encoder data error
Cause		Confirmation	Solution
Encoder data error		Check for interference	Anti-interference treatment

Error code	Main	Extra	Display: "Er 152"
	15	2	Content: Initialized position of encoder error
Cause		Confirmation	Solution
Communication data abnormal		Check encoder power voltage if it is $dc5v \pm 5\%$ or not; check encoder cable and shielded line if it is damaged or not; Check encoder cable if it is intertwined with other power wire or not	Ensure power voltage of encoder normally, ensure encoder cable and shielded line well with FG ground, ensure encoder cable separated with other power wire; Replace the motor with a new one;
Encoder damaged		/	
Encoder measuring circuit damaged		/	

Error code	Main	Extra	Display: "Er 153"
	15	3	Content: Encoder battery under voltage
Cause		Confirmation	Solution
Multi-turn absolute encoder power off		Check battery	Change a battery; Motor damaged, replace the motor with a new one; Clear alarm after changing battery;
		/Check motor	
		/Clear drive alarm	

Error code	Main	Extra	Display: "Er 170"
	17	0	Content: Encoder data error
Cause		Confirmation	Solution
Communication data abnormal		Check encoder power voltage if it is $DC5V \pm 5\%$ or not ; check encoder cable and shielded line if it is damaged or not; check encoder cable whether it is intertwined with other power wire or not	Ensure power voltage of encoder normally, ensure encoder cable and shielded line well with FG ground, ensure encoder cable separated with other power wire; Replace the motor with a new one;
Encoder damaged		/	
Encoder measuring circuit damaged		/	

Error code	Main	Extra	Display: "Er 171"
	17	1	Content: Motor parameters error

Cause	Confirmation	Solution
Motor parameters error		Input motor parameters to match with drive or replace the motor with a new one

Error code	Main	Extra	Display: “Er 180”
	18	0	Content: Position error over-large error
Cause		Confirmation	Solution
Unreasonable set of position error parameter		Check parameter Pr0.14 value if it is too small or not	Enlarge the value of Pr0.14; Enlarge the value of Pr1.00, Pr1.05; Enlarge the value of Pr1.03, Pr5.22; Increase acceleration/ deceleration time decrease speed, decrease load; Check encoder wiring on proper way while multiple drive working;
Gain set is too small		Check parameter Pr1.00, Pr1.05 value if it is too small or not	
Torque limit is too small		Check parameter Pr0.13, Pr5.22 value whether too small or not	
Outside load is too large		Check acceleration/ deceleration time if it is too small or not , check motor rotational speed if it is too big or not ; check load if it is too large or not	

Error code	Main	Extra	Display: “Er 181”
	18	1	Content: Velocity error over-large error
Cause		Confirmation	Solution
The deviation of inner position command velocity is too large with actual speed		Check the value of Pr_602 if it is too small or not	Enlarge the value of Pr_602, or set the value to 0, make position deviation over-large detection invalid; Enlarge the value of Pr_312, Pr_313; Adjust gain of velocity control, improve trace performance;
The acceleration/ decelerate time Inner position command velocity is too small		Check the value of Pr_312, pa_313 if it is too small or not	

Error code	Main	Extra	Display: “Er 190”
	19	0	Content: Motor vibration
Cause		Confirmation	Solution
Overlarge inertia		Check inertia	Cut down the value of Pr003. Pr004; Activate notch function;
Current vibration		Current vibration	
Current loop is too strong		Current loop is too strong	

Error code	Main	Extra	Display: “Er 1A0”
	1A	0	Content: Over-speed 1
Cause		Confirmation	Solution
Motor speed has exceeded the first speed limit (Pr3.21)		Check speed command if it is too large or not; check the voltage of analog speed command if it is too large or not; check the value of pr3.21 if it is too small or not; check input frequency and division frequency coefficient of command pulse if it is proper or not; check encoder if the wiring is correct or not	Adjust the value of input speed command, enlarge the value Pr3.21 value, modify command pulse input frequency and division frequency coefficient, ensure encoder wiring correctly;

Error code	Main	Extra	Display: “Er 1A1”
	1A	1	Content: Speed out of control
Cause		Confirmation	Solution
Control maladjustment		UVW wrong connection	Anti-interference treatment or change motor;
Encoder error		Monitor D30 count increasing	
Special application		The rotation direction of the motor is opposite with motor force direction.	The special assessment of practical application set 0 to 4 for Pr137 to held ERR1A1 alarm;

Error code	Main	Extra	Display: “Er 1b0”
	1b	0	Content: Input pulse format incorrect or out of frequency
Cause		Confirmation	Solution
The input pulse frequency is too high		Too high pulse frequency	To decrease pulse input frequency, less than 500K; Set Pr138 to 2 to turn off alarm;

Error code	Main	Extra	Display: “Er 1b1”
	1b	1	Content: Incorrect electronic gear ratio
Cause		Confirmation	Solution
Out of range		Numerator denominator is zero, or setting values out of range	Reduce the number of pulses per revolution;

Error code	Main	Extra	Display: “Er 210”
	21	0	Content: I/F input interface allocation error
Cause		Confirmation	Solution
The input signal is assigned with two or more functions.		Check the value of Pr_400, Pr_401, Pr_402,Pr_403,Pr_404 if it is proper or not	Ensure the value of Pr_400, Pr_401, Pr_402, Pr_403, Pr_404 set correctly;
The input signal isn't assigned with any functions.		Check the value of Pr_400, Pr_401,Pr_402,Pr_403,Pr_404 if it is proper or not	

Error code	Main	Extra	Display: “Er 211”
	21	1	Content: I/F input interface function set error
Cause		Confirmation	Solution
Signal allocation error		Check the value of Pr_400, Pr_401, Pr_402,pa_403,pa_404 if it is proper or not	Ensure the value of Pr_400, Pr_401, Pr_402, Pr_403, Pr_404 set correctly;

Error code	Main	Extra	Display: “Er 212”
	21	2	Content: I/F input interface function set error
Cause		Confirmation	Solution
The input signal is assigned with two or more functions.		Check the value of Pr_410, Pr_411, Pr_412, Pr_413, if it is	Ensure the value of Pr_410, Pr_411, Pr_412,Pr_413 set correctly;

	proper or not	
The input signal isn't assigned with any functions.	Check the value of Pr_410, Pr_411, Pr_412, Pr_413, if it is proper or not	

Error code	Main	Extra	Display: “Er 240”
	24	0	Content: CRC verification error when EEPROM parameter is saved
Cause		Confirmation	Solution
L1,L2,L3 terminal under-voltage		Check L1,L2,L3 terminal voltage	Ensure L1,L2,L3 terminal voltage in proper range; Replace the drive with a new one; Download the suitable project file to drive for motor;
Drive is damaged		save the parameters again	
The setting of drive maybe default setting which isn't suitable for motor.		Check the setting of drive if it is suitable for your motor	

Error code	Main	Extra	Display: “Er 260”
	26	0	Content: Positive negative over-travel input valid
Cause		Confirmation	Solution
Positive /negative over-travelling input signal has been conducted		Check the state of positive negative over-travel input signal	/

Error code	Main	Extra	Display: “Er 270~ Er 272”
	27	0~2	Content: Analog input out of range
Cause		Confirmation	Solution
Analog input out of range			Try to adjust analog input within limited range;

Error code	Main	Extra	Display: “ Er 570”
	57	0	Content: Forced alarm input valid
Cause		Confirmation	Solution
Forced-alarm input signal has been conducted		Check forced-alarm input signal	Ensure input signal wiring correctly;

6.3 Alarm Clear

For alarm can be cleared:

- Use auxiliary function “AF_ACL”
 - Press M to select auxiliary function
 - Press SET to enter into “AF_ACL”
 - Press and hold ◀ to clear the alarm
- Set IO input function as Alarm clear input “(A-CLR)”, refer to switch input interface connection to clear the alarm

For alarm cannot be cleared:

- Restart the power-supply to clear the alarm.

Chapter 7 Display and Operation

7.1 Introduction

The operation interface of servo drive consists of six LED nixie tubes and five key, which are used for servo drive's status display and parameter setting. The inter face layout is as follows :



Figure 7-1 front panel

Table 7.1 The name and function of keys

Name	Key	Function
Display	/	There are 5 LED nixie tubes to display monitor value, parameter value.
Mode key	M	Press this key to switch among 4 modes: 1.Data monitor mode 2.Parameter setting mode 3.Auxiliary function mode 4.EEPROM written mode
Set key	Set	Entrance for submenu, confirming the current setting
Up key	▲	Press this key to increase the current setup value
Down key	▼	Press this key to decrease the current setup value
Left key	◀	Press this key to shift to the next digit on the left

7.2 Panel Display and Operation

7.2.1 Panel Operation Flow Figure

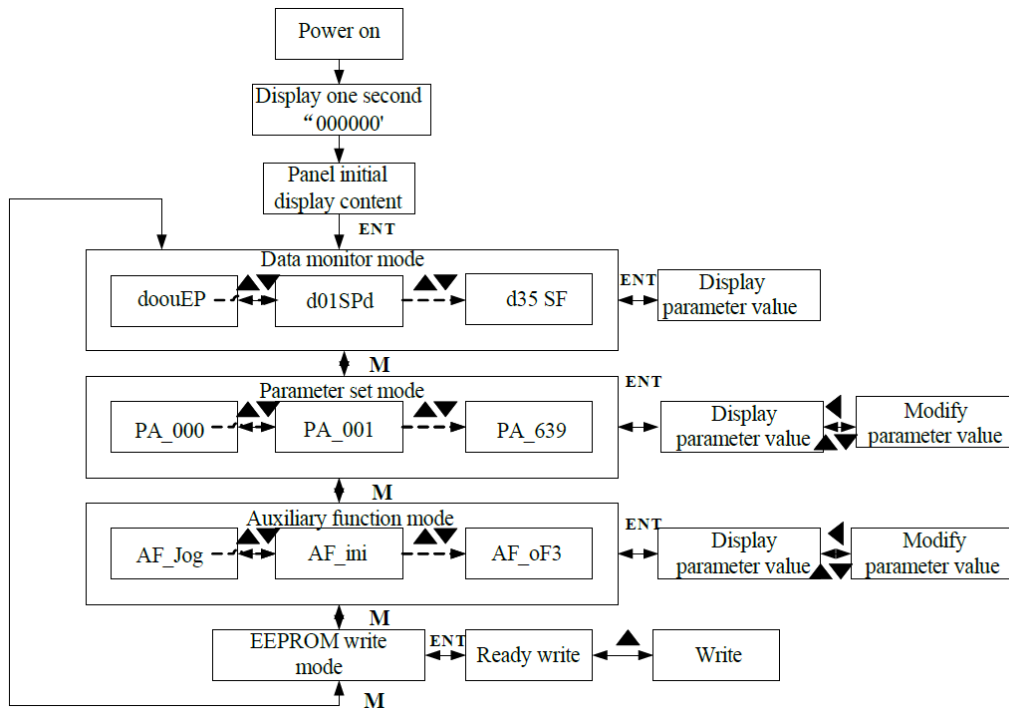
Figure 7-2 the flow diagram of panel operation

- (1) The front panel display **rEAdY** for about one second firstly after turning on the power of the drive. Then if no abnormal alarm occurs, monitor mode is displayed with the value of initial parameter; otherwise, abnormal alarm code is displayed.
- (2) Press M key to switch the data monitor mode → parameter setting mode → auxiliary function mode → EEPROM written mode.
- (3) If new abnormal alarm occurs, the abnormal alarm will be displayed immediately in abnormal mode No. matter what the current mode is, press M key to switch to the other mode.
- (4) In data monitor mode, press ▲ or ▼ to select the type of monitor parameter; Press ENT to enter the parameter type , then press ◀ to display the high 4 bits “H” or low 4 bits “L” of some parameter values.
- (5) In parameter setting mode, press ◀ to select current editing bit of parameter. Press ▲ or ▼ to change current editing bit of parameters. Press ENT key to enter the parameter setting mode of corresponding parameters. Press ◀ to select current bit of parameter value when editing it, press ▲ or ▼ to change the value of the bit. Press ENT to save it and switch to the interface of parameter.

7.2.2 Drive Operating Data Monitor

Table 7.2 Function List of Drive Monitor

Serial Number	Name	Specification	Display	Unit	Data Format (X, Y Is Numerical Value)
0	d00uE	Positional command deviation	d00uE	pulse	Low-bit “L xxxx” High-bit “H xxxx”
1	d01SP	Motor speed	d01SP	r/min	“r xxxx”
2	d02cS	Positional command speed	d02CS	r/min	“r xxxx”
3	d03cu	Velocity control command	d03Cu	r/min	“r xxxx”

4	d04tr	Torque feedback	d04tr	%	“r xxxx”
5	d05nP	Feedback pulse sum	d05nP	pulse	Low-bit “L xxxx” High-bit “H xxxx”
6	d06cP	Command pulse sum	d06CP	pulse	Low-bit “L xxxx” High-bit “H xxxx”
7	d07	Maximum torque feedback	d07	/	“ xxxx”
8	d08FP	Frequency of pulse signal	d08FP	pulse	Low-bit “L xxxx” High-bit “H xxxx”
9	d09cn	Control mode	d09Cn	/	Position: “PoScn” Speed: “SPdcn” Torque: “trqcn” Composite mode cnt”
10	d10Io	I/O signal status	d10 Io	/	Refer instructions for details
11	d11Ai	Analog input value	d11Ai	v	“x yyyy” x: AI1 A, AI2 b, AI3 c yyyy: value
12	d12Er	Error factor and reference of history	d12Er	/	“Er xxx”
13	d13 rn	Alarm display	d13rn	/	“m xxx”
14	d14 r9	Regeneration load factor	d14r9	%	“rg xxx”
15	d15 oL	Over-load factor	d15oL	%	“oL xxx”
16	d16Jr	Inertia ratio	d16Jr	%	“J xxx”
17	d17ch	Factor of No.-motor running	d17Ch	/	“cP xxx”
18	d18ic	No. of changes in I/O signals	d18ic	/	“n xxx”
19	d19	/	d19	/	“ xxxx”
20	d20Ab	Absolute encoder data	d20Ab	pulse	Low-bit “L xxxx” High-bit “H xxxx”
21	d21AE	Absolute external scale position	d21AE	pulse	Low-bit “L xxxx” High-bit “H xxxx”
22	d22rE	No. of Encoder/external scale communication errors monitor	d22rE	times	“n xxx”
23	d23 id	Communication axis address	d23id	/	“id xxx” “Fr xxx”
24	d24PE	Encoder positional deviation(encoder unit)	d24PE	pulse	Low-bit “L xxxx” High-bit “H xxxx”
25	d25PF	Encoder scale deviation (external scale unit)	d25PF	pulse	Low-bit “L xxxx” High-bit “H xxxx”
26	d26hy	hybrid deviation (command unit)	d26hy	pulse	Low-bit “L xxxx” High-bit “H xxxx”
27	d27 Pn	Voltage across PN [V]	d27Pn	V	“u xxx”
28	d28 No.	Software version	d28No.	/	“d xxx” “F xxx” “P xxx”
29	d29AS	Drive serial number	d29AS	/	“n xxx”
30	d30NS	Motor serial number	d30sE	/	Low-bit “L xxxx” High-bit “H xxxx”
31	d31 tE	Accumulated operation time	d31tE	/	Low-bit “L xxxx” High-bit “H xxxx”
32	d32Au	Automatic motor identification	d32Au	/	“r xxx”
33	d33At	Drive temperature	d33At	°C	“th xxx”
34	d34	/	d34	/	“t xxx”

35	d35 SF	Safety condition monitor	d35SF	/	“xxxxxx”
----	--------	--------------------------	-------	---	----------

Instructions:
1. d01SP Motor speed

Drive display **s 0** after power on, in disable state. While in enable state, display **r 0**. Motor speed display **r xxx**. So users can distinguish in disable state or in enable state by display **s 0** or **r 0**.

2. d10 Io I/O signal status

The upper half of the nixie tube is valid, the lower half is invalid, the decimal point represents the input and output state, lit represents the input, Not bright represents the output

Input: , from low to high, the order is SI1, SI2...SI10. The next figure represents SI1/SI8/SI10 input are valid, other inputs are invalid.



Output: , from low to high, the order is SO1, SO2...SO10. The next figure represents SO1 output are valid, other inputs are invalid.

3. d11Ai Analog input value

d11Ai is used to monitor the state of the three channels of simulation. The horizontal line on the leftmost digital tube represents which channel of simulation, specifically, the horizontal line above represents the first channel of simulation, the horizontal line in the middle represents the second channel of simulation, and the horizontal line below represents the third channel of simulation. The analog display unit is 0.001V, and the fourth and fifth decimal places on the right represent negative signs. Analog monitoring switch by up and down keys. Example the third analog value of -11.5v is shown as follows:

4. Parameter high and low bit, positive and negative Numbers.

The highest and lowest digits of data and the signs are shown as follows. The first and second decimal points on the right are bright, indicating the data of high order. The two decimal points are Not lit, indicating the data of low order. The fourth and fifth decimal places on the right indicate negative Numbers, otherwise positive Numbers

Users can choose to set the initial display state of power supply to any of the below:

Pr5.28 *	Name	LED initial status			Mode	P	S	T
	Range	0~35	Unit	—	Default	1		
	Data Type	16bit	Access	R/W	Address	0539H		
	Repower	-						

You can select the type of data to be displayed on the front panel LED (7-segment) at the initial status after power-on.

Setup Value	Content	Setup Value	Content	Setup Value	Content
0	Positional command deviation	10	I/O signal status	27	Voltage across PN [V]
1	Motor speed	11	Analog input value	28	Software version
2	Positional command speed	12	Error factor and reference of history	29	Drive serial number
3	Velocity control command	16	Inertia ratio	30	Motor serial number
4	Torque command	17	Factor of No.-motor running	31	Accumulated operation time
5	Feedback pulse sum	23	Communication axis address	33	Temperature information
6	Command pulse sum	24	Encoder positional deviation [encoder unit]	36	Safety condition monitor
9	Control mode				

Table 7.3 “d17 ch” Motor No. Rotate Reason Code Definition

Code	Display Code	Specification	Content
0	cP 0	Working Normally	
1	cP 1	DC bus under-voltage	/
2	cP 2	No. entry of Srv-On input	The Servo-ON input (SRV-ON) is Not connected to COM-
3	cP 3	POT/NOT input is valid	Pr_504=0,POT is open , speed command is positive direction NOT is open , speed command is negative direction
4	cP 4	Drive fault	/
5	cP 5	The relay inside the drive isn't closed	/
6	cP 6	Pulse input prohibited (INH)	Pr518=0,INH is open
8	cP 8	CL is valid	Pr517=0,deviation counter clear is connected to COM-
9	cP 9	speed zero-clamp is valid	Pr315=1, speed zero-clamp is open

7.2.3 Auxiliary Function

Table 7.4 setting interface System parameter

No.	Name	Specification	Display Code	Operation Flow
0	AFjog	Trial run	AFjog	Please refer to the chapter of“trial run”
1	AFInI	Initialization of parameter	AFInI	1. press SET to enter operation, display “InI -”. 2.press ▲ once to display “InI---”, indicated initialization; after finishing it, display“FinSh”.
2	AFunL	Release of front	AFunL	1. press SET to enter operation, display “unL -”.

		panel lock		2. press ▲ button one time , display “FinSh”, indicated unlock the panel successfully
3	AFAcL	Alarm clear	AFAcL	1. press SET to enter operation, display “Acl -”. 2. press ▲ once , display “FinSh”, indicated alarm clear successfully
4	AFoF1	A1 automatic offset adjustment	AFoF1	1. press SET to enter operation, display “of1 -”. 2. press ▲ once , display “StArt”, indication start correct, then display “FiniSh” indicated correction finished.
5	AFoF2	A2 automatic offset adjustment	AFoF2	1. press SET to enter operation, display “oF2 -”. 2. press ▲ once , display “StArt”, indicated start to correct the offset, then display “FinSh” indicated that correction finished.
6	AFoF3	A3 automatic offset adjustment	AFoF3	1. press SET to enter operation, display “oF3 -”. 2. press ▲ once , display “StArt”, indicated start to correct the offset, then display “FinSh” indicated correction finished .
7	AFEnc	Motor Angle correction	AFEnc	1. Press SET once to enter operation, display “Enc -” 2. press ▲ once , display “StArt”, indicated start to correct the angle, then display “FiniSh” indicated correction finished
8	AF tUn	Reserved	AFtUn	
9	AF_GL	Inertia ratio identification	AF_GL	1. Press SET once to enter operation, display “G---” 2. Press ◀ once, display “StUon” 3. Press ▲, motor running, indicated start to identification 4. Finishing, display G xxx, xxx indicated Inertia ratio value
10	AFrSt	Soft reset	AFrSt	1. Press SET once to enter operation, display “rSt -” 2. Press ▲ and hold on, display “StArt” Then, finished

Table 7.5 The Locked Panel Conditions

Mode	The Locked Panel Conditions
Monitor mode	No. limitation: all monitored data can be checked.
Parameter set up mode	No. parameter can be changed but setting can be checked.
Auxiliary function mode	CanNot be run except for” release of front panel lock”
EEPROM writing mode	No. limitation

7.2.4 Saving Parameter

Operation procedure:

1. press M to select EEPROM writing mode, display “EESet”;
2. Press ENT to enter into writing mode operation:
3. Press and hold ▲, display LED from” EP -” to” EP--”, then it becomes” EP---”, finally it become” StArt”,

indicated EEPROM writing operation have been began;

4. “Error” means that writing is unsuccessful, while “Finish” show that the writing is successful; Follow steps 3 and 4 to repeat the operation; the drive may be damaged if repeat of several times still fails. The drive needs to repair.

5. The drive needs to power off and restart again if writing is successful.

NOTE: Don’t turn off the power if EEPROM writing operation goes on, otherwise it may cause writing wrong data; if this happens, please reset all the parameters, then do EEPROM writing operation again.

7.2.5 Abnormal Alarm

The front panel will automatically enter the abnormal alarm display mode if drive error occurs while it displays the corresponding error code. Please refer to Chapter 6 of alarm processing about the detail of error code.

7.3 Trial Run

Attention

- Ground the earth terminal of the motor and drive without fail, the PE terminal of drive must be reliably connected with the grounding terminal of equipment.
- The drive power need with isolation transformer and power filter in order to guarantee the security and anti-jamming capability.
- Check the wiring to make sure correctness before power on.
- Install a emergency stop protection circuit externally, the protection can stop running immediately to prevent accident happened and the power can be cut off immediately.
- If drive alarm occurs, the cause of alarm should be excluded and servo on signal must be invalid before restarting the drive.
- The high voltage also will contain in several minutes even if the servo drive is powered off, please don’t touch terminal strip or separate the wiring.
-

Note: there are two kinds of trial run: trial run without load and trial run with load. The user needs to test the Drive without load for safety first.

Contact tech@leadshine.com if you need more technical service.

7.3.1 Inspection before Trial Run

Table7.6 Inspection Item Before Run

No.	Item	Content
1	Inspection on wiring	1. Ensure the following terminals are properly wired and securely connected : the input power terminals, motor output power terminal ,encoder input terminal CN2, control signal terminal CN1, communication terminal CN4(it is unnecessary to connect CN1 andCN4 in Jog run mode) 2. Short among power input lines and motor output lines are forbidden, and No. short connected with PG ground.
2	Confirmation of power supply	1. The range of control power input r; t must be in the rated range. 2. The range of the main power input R, S, T must be in the rated range. 3. Single phase 220VAC input is sufficient if the power of drive is No. more 1.5kw.
3	Fixing of	The motor and drive must be firmly fixed

	position	
4	Inspection without load	The motor shaft must Not be with a mechanical load.
5	Inspection on control signal	1, all of the control switch must be placed in OFF state. 2, servo enables input "Srv_on" must be in OFF state.

7.3.2 Timing Chart on Power-Up

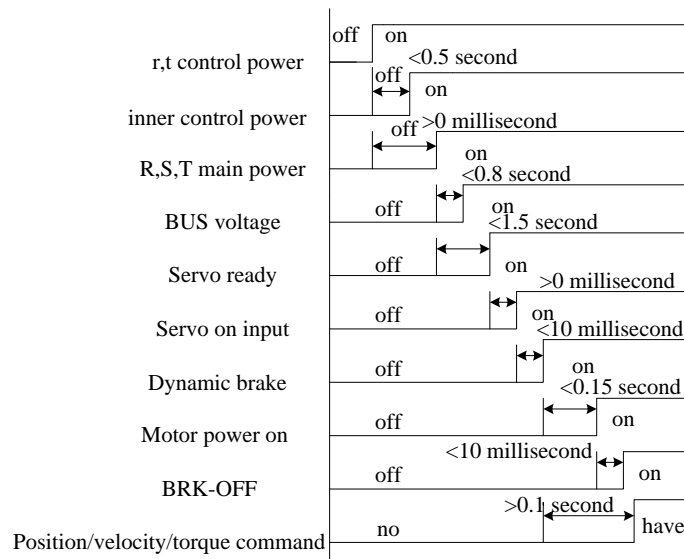

7.3.3 Timing Chart on Fault

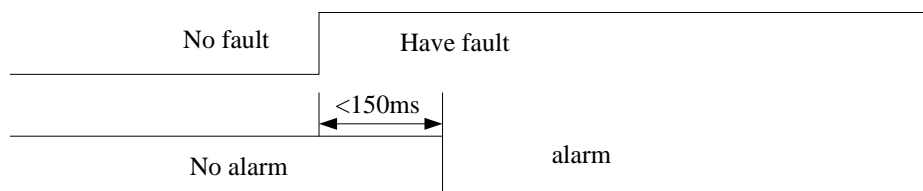

7.3.4 Holding Brake

In applications where the motor drive the vertical axis, this brake would be used to hold and prevent the work (moving load) from falling gravity while the power to the servo is shut off .

**Never use this for "Brake" purpose to stop the load in motion.
Use this built-in brake for "holding" purpose only. That is to hold the stalling status.**

For the brake release timing at power-on ,or braking timing at servo-off/servo-alarm while the motor is in motion ,refer to chapter 7.1.2 timing chart on power-up.

You can follow the diagram about the wiring below:

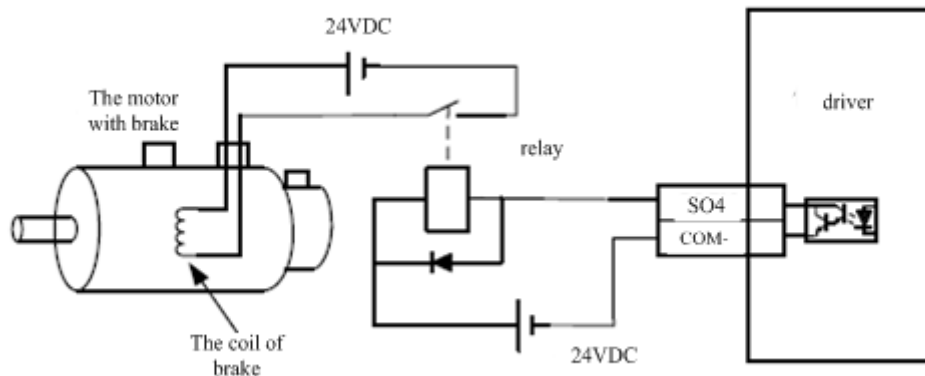

About the wire of brake, there should be an 24VDC for brake, the brake will be loosed with the 24VDC input, and the drive give an output signal to control the connection or disconnection of the 24VDC, pin 31 and pin 35 of CN1 is the control signal, and it is forbidden to connect these signal directly for the power of 24VDC, it will destroy the hardware of servo drive.

And if you connect the pin31 and pin35 for controlling the brake, just make sure the setting value of Pr4.13. The default is 00000303h, if the drive works in torque mode, this value should be changed to 00030303h.

7.3.5 Trial Run Jog Control

After installation and connection is completed, check the following items before turning on the power:

- Wiring.(Especially power input and motor output)
- Short or grounded.
- Loose connection.
- Unstable mounting.
- Separation from the mechanical system.

It is unnecessary to connect control signal terminal CN1 and communication terminal CN4 in Jog run mode. It is recommended that motor runs at low speed for safety, while the speed depends on the parameters below: there are two different modes : **speed JOG mode** and **location JOG mode**.

Table 7.7 Parameter Setup of Velocity JOG







No.	Parameter	Name	Set Value	Unit
1	Pr0.01	Control mode setting	1	/
2	Pr3.12	Acceleration time setup	User-specified	millisecond
3	Pr3.13	Deceleration time setup	User-specified	millisecond
4	Pr3.14	Sigmoid acceleration/deceleration time setup	User-specified	millisecond
5	Pr6.04	JOG trial run command speed	User-specified	rpm

Table 7.8 Parameter Setup of Position JOG

No.	Parameter	Name	Value	Unit
1	Pr0.01	Control mode setting	0	/
2	Pr3.12	Acceleration time setup	User-specified	millisecond
3	Pr3.13	Deceleration time setup	User-specified	millisecond
4	Pr3.14	Sigmoid acceleration/deceleration time setup	0	millisecond
5	Pr6.04	JOG trial run command speed	User-specified	rpm
6	Pr6.20	distance of trial running	User-specified	0.1 rotation

7	Pr6.21	waiting time of trial running	User-specified	millisecond
8	Pr6.22	cycling times of trial running	User-specified	times

◆JOG trial run operation process

1. Set all parameters above corresponding to velocity JOG or position JOG;
2. Enter EEPROM writing mode, and save the value of modified parameters ;
3. The drive need to restart after the value is written successfully;
4. Enter auxiliary function mode, and go to “AFJog ”sub-menu;
5. Press ENT once, and display **Jog -** ”;
6. Press  once, and display ” **Srvon** ” if No. exception occurs; press  once again if “**Error** ” occurs, it should display “**Srvon** ”; If “**Error** ” still occurs, please switch to data monitoring mode “**d17 Ch** ”sub-menu, find the cause why motor doesn’t rotate, fix the trouble and try again;
7. In position JOG mode, the motor will rotate directly; if motor doesn’t rotate, switch to data monitoring mode **d17 Ch** ”sub-menu, find the cause why motor doesn’t rotate, fix the trouble and try again;
In speed JOG mode, press  once, the motor rotates once (hold  will make motor rotating to value of Pr6.04); press  once, the motor rotates once (hold  will make motor rotating to value of Pr6.04); if motor doesn’t rotate, switch to data monitoring mode **d17 Ch** ”sub-menu, find the cause why motor doesn’t rotate, fix the trouble and try again;
8. Press SET will exit JOG control in JOG run mode.

Chapter 8 Application Case

Operation Mode Selection

ELP series AC servo drive support the position, speed, torque three basic modes of operation, and can switch freely between the three basic modes of operation by switch or modify parameters.

Table 8.1 Parameter setup of Operation Mode Selection

No.	Mode	Parameter	Specification
1	Position mode	Pr0.01=0	The position control is performed based on the positional command (pulse train) from the host controller or the command set in the servo drive.
2	Velocity mode	Pr0.01=1	The velocity control is performed according to the analog speed command from the host controller or the speed command set in the servo drive.
3	Torque mode	Pr0.01=2	The torque control is performed according to the torque command specified in the form of analog voltage or the command set in the servo drive.
4	1st mode: position mode 2nd mode: speed mode	Pr0.01=3	The control mode is switched through external input.
5	1st mode: position mode 2nd Mode: torque mode	Pr0.01=4	The control mode is switched through external input.
6	1st mode: speed mode 2nd Mode: torque mode	Pr0.01=5	The control mode is switched through external input.

The step of changing the operation mode:

- 1, Switch the drive to Servo Off status.
 - 2, Modify the corresponding parameters of control mode to EEPROM.
- Turn off/on the power to make the new mode works after setup completed.

8.1 Position Control

Notice: You must do inspection before position control test run.

Table 8.2 Parameter Setup of Position Control

No.	Parameter	Name	Input	Value	Unit
1	Pr0.01	control mode setup	/	0	/
2	Pr0.06	command pulse rotational direction setup		0	
3	Pr0.07	command pulse input mode setup		0~3	
4	Pr0.08	Command pulse per one motor revolution		User-specified	Pulse
5	Pr0.09	1st numerator of electronic gear		1	
6	Pr0.10	denominator of electronic gear		1	
7	Pr2.22	positional command smoothing filter		User-specified	0.1ms
8	Pr2.23	positional command FIR filter		User-specified	0.1ms
9	Pr3.12	Acceleration time setup	/	User-specified	millisecond

10	Pr3.13	Deceleration time setup	/	User-specified	millisecond
11	Pr3.14	Sigmoid acceleration/deceleration time setup	/	User-specified	millisecond
12	Pr4.00	SI1 input select: servo-enable	Srv_on	Hex:0003	/

◆ Wiring Diagram

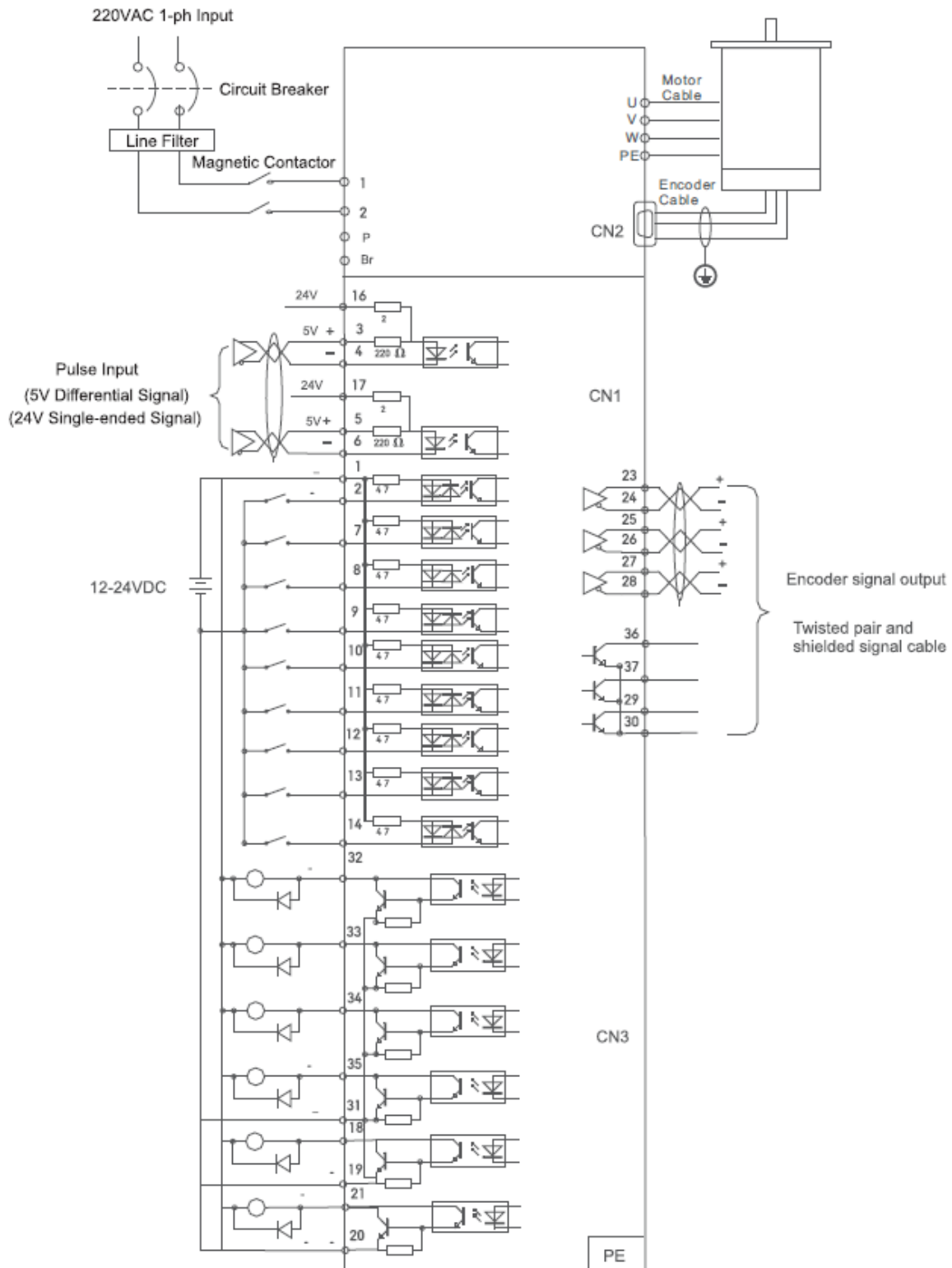

Figure 8-1 Position Mode Typical Wiring Diagram

Note:

For drive is more than 1.5kw, 3 phase is better than single phase, connect L1, L2, L3

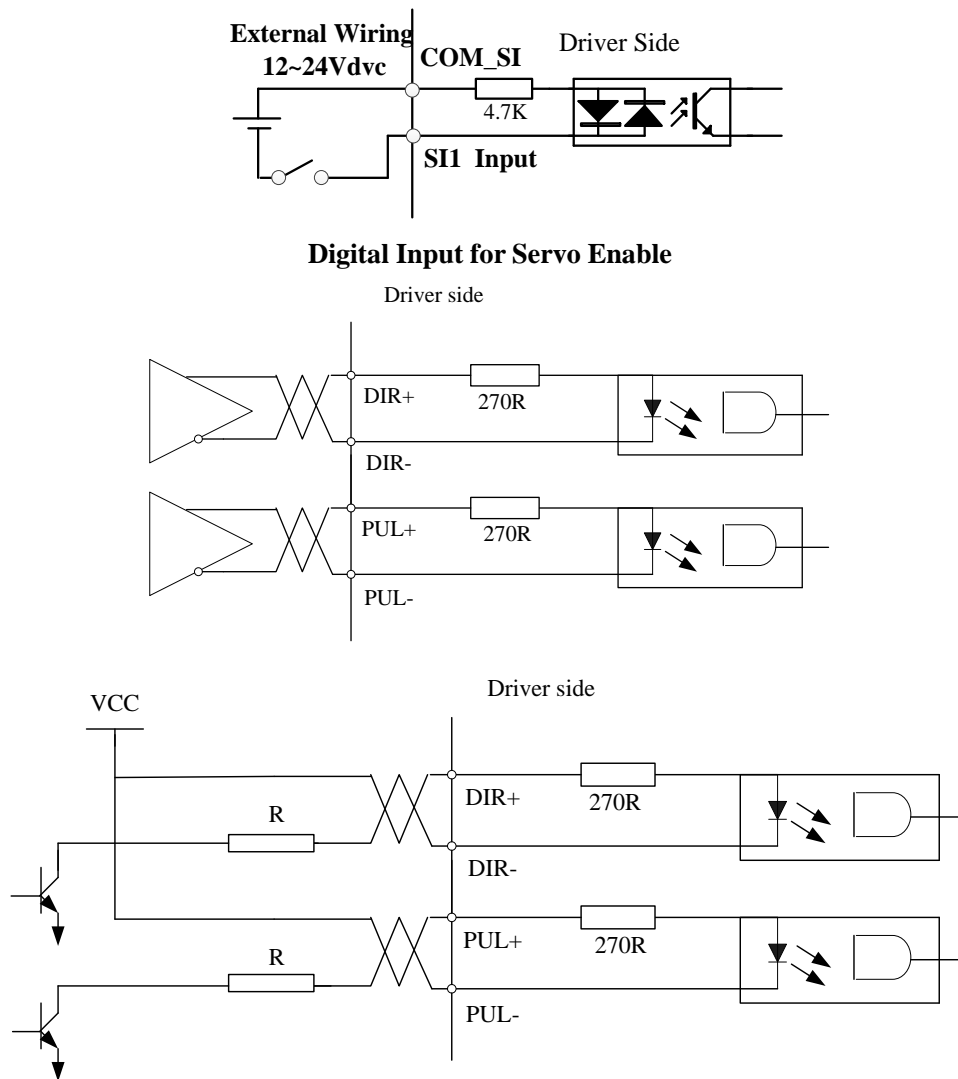

Figure 8-2 Control Terminal CN1 Signal Wiring in Position Control Mode

◆ Operation Steps

1. Connect terminal CN1.
2. Enter the power (DC12V to 24V) to control signal (the COM_SI + and SII).
3. Enter the power to the drive.
4. Confirm the value of the parameters, and write to the EEPROM and turn off/on the power (of the drive)
5. Connect the “Srv_on” input to bring the drive to servo-on status and energize the motor.
6. Enter low-frequency pulse and direction signal to run the motor at low speed.
7. Check the motor rotational speed at monitor mode whether, (“d01SP”),
 Rotational speed is as per the setup or Not, and
 The motor stops by stopping the command (pulse) or Not
 if the motor does Not run correctly, refer to the Factor of No.-Motor running in data monitor mode
 (“d17Ch”).

The drive is widely used for precise positioning in position control mode.

Related parameters setup of position mode





8.1.1 Pulse Command and Rotation Direction

The positional commands of the following 3 types (pulse train) are available.

- ◆Phase A/B pulse
- ◆Positive direction pulse/negative direction pulse
- ◆Pulse + direction

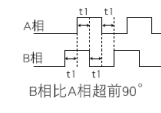
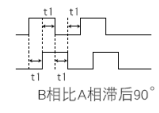
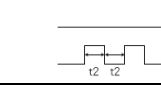
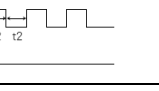
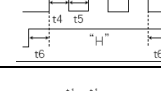
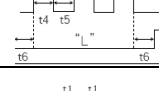
Please set the pulse configuration and pulse counting method based on the specification and configuration of installation of the host controller.

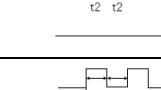
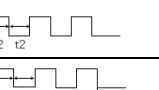
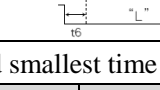
Pr0.06*	Name	Command pulse rotational direction setup			Mode	P	
	Range	0~1	Unit	—	Default	0	
	Data length	16bit	Access	R/W	Address	0x 000D	
	Effective	Power-on again					
Set command pulse input rotate direction, command pulse input type							
Pr0.07*	Name	Command Pulse Input Mode Setup			Mode	P	
	Range	0~3	Unit	—	Default	1	
	Data length	16bit	Access	R/W	Address	0x 000F	
	Effective	Power-on again					

Pr0.06	Pr0.07	Command pulse format	Signal	Positive direction command	Negative direction command
0	0 or 2	90 phase difference 2-phase pulse(phase A +phase B)	Pulse sign		
	1	Positive direction pulse + negative direction pulse	Pulse sign		
	3	Pulse + sign	Pulse sign		
1	0 or 2	90 phase difference 2 phase pulse(phase A +phase B)	Pulse sign		
	1	Positive direction pulse + negative direction pulse	Pulse sign		
	3	Pulse + sign	Pulse sign		

Command pulse input signal allow largest frequency and smallest time width

Puls/sign signal input I/F		Permissible max. Input frequency	Smallest time width					
			t1	t2	t3	t4	t5	t6
Pulse series interface	Long distance interface	500kpps	2	1	1	1	1	1
	Open-collector output	200kpps	5	2.5	2.5	2.5	2.5	2.5

8.1.2 Electronic Gear Function

The function multiplies the input pulse command from the host controller by the predetermined dividing or multiplying factor and applies the result to the position control section as the positional command. By using this function, desired motor rotations or movement distance per unit input command pulse can be set.

Pr0.08	Name	Command pulse counts per one motor revolution			Mode	P	V	T
	Range	0-8388608	Unit	P	Default	0		
	Data length	32bit	Access	R/W	Address	0x 0010 0x 0011		
	Effective	Power-on again						

Set the command pulse that causes single turn of the motor shaft.

1) If Pr008≠0, the actual motor rotation turns = pulse number / Pr008

2) If Pr008 = 0, Pr0.09 1st numerator of electronic gear and Pr0.10 denominator of electronic gear become valid.

Pr0.09	Name	1st numerator of electronic gear			Mode	P		
	Range	1~1073741824	Unit	—	Default	1		
	Data length	32bit	Access	R/W	Address	0x 0012 0x 0013		
	Effective	Power-on again						

Set the numerator of division/multiplication operation made according to the command pulse input.

Pr0.10	Name	1st denominator of electronic gear			Mode	P		
	Range	1~1073741824	Unit	—	Default	1		
	Data length	32bit	Access	R/W	Address	0x 0014 0x 0015		
	Effective	Power-on again						

Set the denominator of division/multiplication operation made according to the command pulse input.

Pr0.09	Pr0.10	Command division/multiplication operation	
1-10737 41824	1-10737 41824	Command pulse input →	<div style="border: 1px solid black; padding: 5px; display: inline-block;"> 【Pr0.09 set value】 【Pr0.10 set value】 </div> → position command

1. Settings:

1)The drive input command pulse number is X

2)The pulse number of encoder after frequency division and frequency doubling is Y

3)The number of pulses per revolution of the motor encoder is Z

4)Number of turns of motor is W

2. Calculations:

1)Y=X* Pr0.09 / Pr0.10

2)17-bit encoder: Z=2¹⁷ = 131072

23-bit encoder: Z=2²³ = 8388608

8.1.3 Position Command Filter

To make the positional command divided or multiplied by the electronic gear smooth, set the command filter. In the following situations, it is necessary to consider adding position command filtering:

- (1) The position instruction output by the controller is not accelerated or decelerated;
- (2) Low command pulse frequency;
- (3) When the electronic gear ratio is more than 10 times.

The position command filter can make the position command smoother and the motor rotation more stable.

Pr2.22	Name	Positional command smoothing filter			Mode	P	
	Range	0~32767	Unit	0.1ms	Default	0	
	Data length	16bit	Access	R/W	Address	0x 022D	
	Effective	Power-on again					

- Set up the time constant of the 1st delay filter in response to the positional command.
- When a square wave command for the target speed V_c is applied, set up the time constant of the 1st delay filter as shown in the figure below

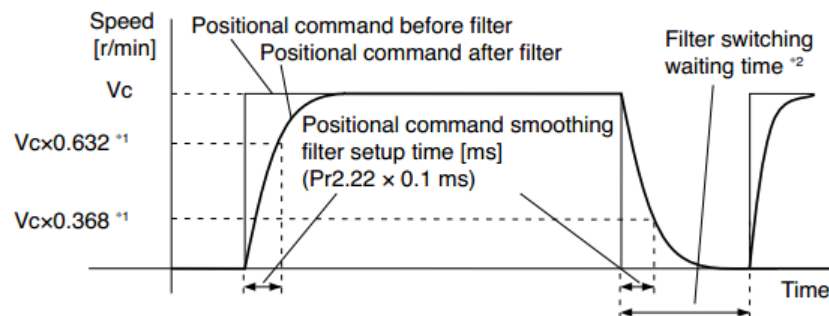

Pr2.23	Name	Positional command FIR filter			Mode	P	
	Range	0~10000	Unit	0.1ms	Default	0	
	Data length	16bit	Access	R/W	Address	0x 022F	
	Effective	Power-on again					

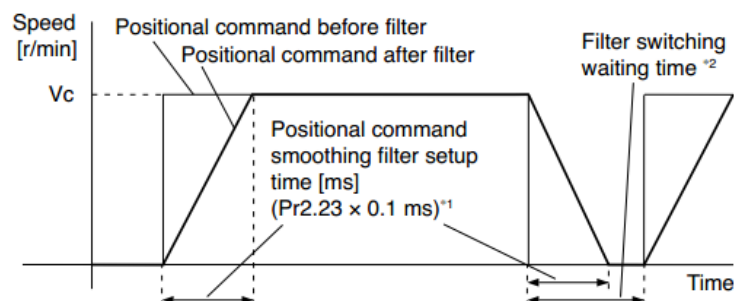

- Set up the time constant of the 1st delay filter in response to the positional command.
- When a square wave command for the target speed V_c is applied, set up the V_c arrival time as shown in the figure below.



8.1.4 Motor Encoder Pulse Output

The information on the amount of movement can be sent to the host controller in the form of A and B phase pulses from the servo drive.

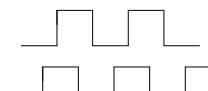
Pr0.11 *	Name	Output pulse counts per one motor revolution			Mode	P	V	T
	Range	1~2500	Unit	P/r	Default	2500		
	Data length	16bit	Access	R/W	Address	0x 0017		
	Effective	Power-on again						
For example, if this parameter is set to 1000, it means that the frequency division output signal of the encoder outputs 4000 pulses per turn.								

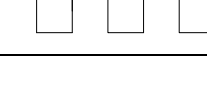
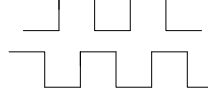
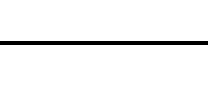
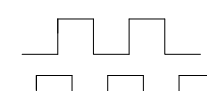
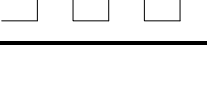
Pr0.12 *	Name	Reversal of pulse output logic			Mode	P	V	T
	Range	0~1	Unit	—	Default	0		
	Data length	16bit	Access	R/W	Address	0x 0019		
	Effective	Power-on again						
You can set up the phase B logic and the output source of the pulse output. With this parameter, you can reverse the phase relation between the phase A pulse and phase B pulse by reversing the phase B logic. < reversal of pulse output logic >								
	Pr0.12	phase A Logic	CCW direction rotation	CW direction rotation				
	0	Standard	Phase A  Phase B 	Phase A  Phase B 				
	1	Reverse	phase A  Phase B 	Phase A  Phase B 				

8.1.5 Position Complete Output (INP)

The completion of positioning can be verified by the positioning complete output (INP). When the absolute value of the positional deviation counter at the position control is equal to or below the positioning complete

Range by the parameter, the output is ON. Presence and absence of positional command can be specified as one of judgment conditions.

Pr4.31	Name	Positioning complete range			Mode	P		
	Range	0~10000	Unit	0.0001rev	Default	10		
	Data length	16bit	Access	R/W	Address	0x 043F		
	Effective	Immediate						
Set up the timing of positional deviation at which the positioning complete signal (INP1) is output.								

Pr4.32	Name	Positioning complete output setup			Mode	P		
	Range	0~3	Unit	command unit	Default	0		

	Data length	16bit	Access	R/W	Address	0x 0441
	Effective	Immediate				
Select the condition to output the positioning complete signal (INP1).						
	Setup Value	Action Of Positioning Complete Signal				
	0	The signal will turn on when the positional deviation is smaller than Pr4.31 [positioning complete range].				
	1	The signal will turn on when there is No. position command and position deviation is smaller than Pr4.31 [positioning complete range].				
	2	The signal will turn on when there is No. position command, the zero-speed detection signal is ON and the positional deviation is smaller than Pr4.31 [positioning complete range].				
	3	The signal will turn on when there is No. position command and the positional deviation is smaller than Pr4.31 [positioning complete range]. Then holds "ON" states until the next position command is entered. Subsequently, ON state is maintained until Pr4.33 INP hold time has elapsed. After the hold time, INP output will be turned ON/OFF according to the coming positional command or condition of the positional deviation.				

Pr4.33	Name	INP hold time			Mode	P		
	Range	0~30000	Unit	1ms	Default	0		
	Data length	16bit	Access	R/W	Address	0x 0443		
	Effective	Immediate						
Set up the hold time when Pr 4.32 positioning complete output setup=3								
	Setup Value	State Of Positioning Complete Signal						
	0	The hold time is maintained definitely, keeping ON state until next positional command is received.						
	1-30000	ON state is maintained for setup time (ms) but switched to OFF state as the positional command is received during hold time.						

And the output port should be assigned for "INP", for details of these parameters, refer to Pr_410 – Pr415.

8.2 Velocity Control

The drive is widely used for accuracy speed control in velocity control mode. You can control the speed according to the analog speed command from the host controller or the speed command set in servo drive.

Notice: You must do inspection before position control test run.

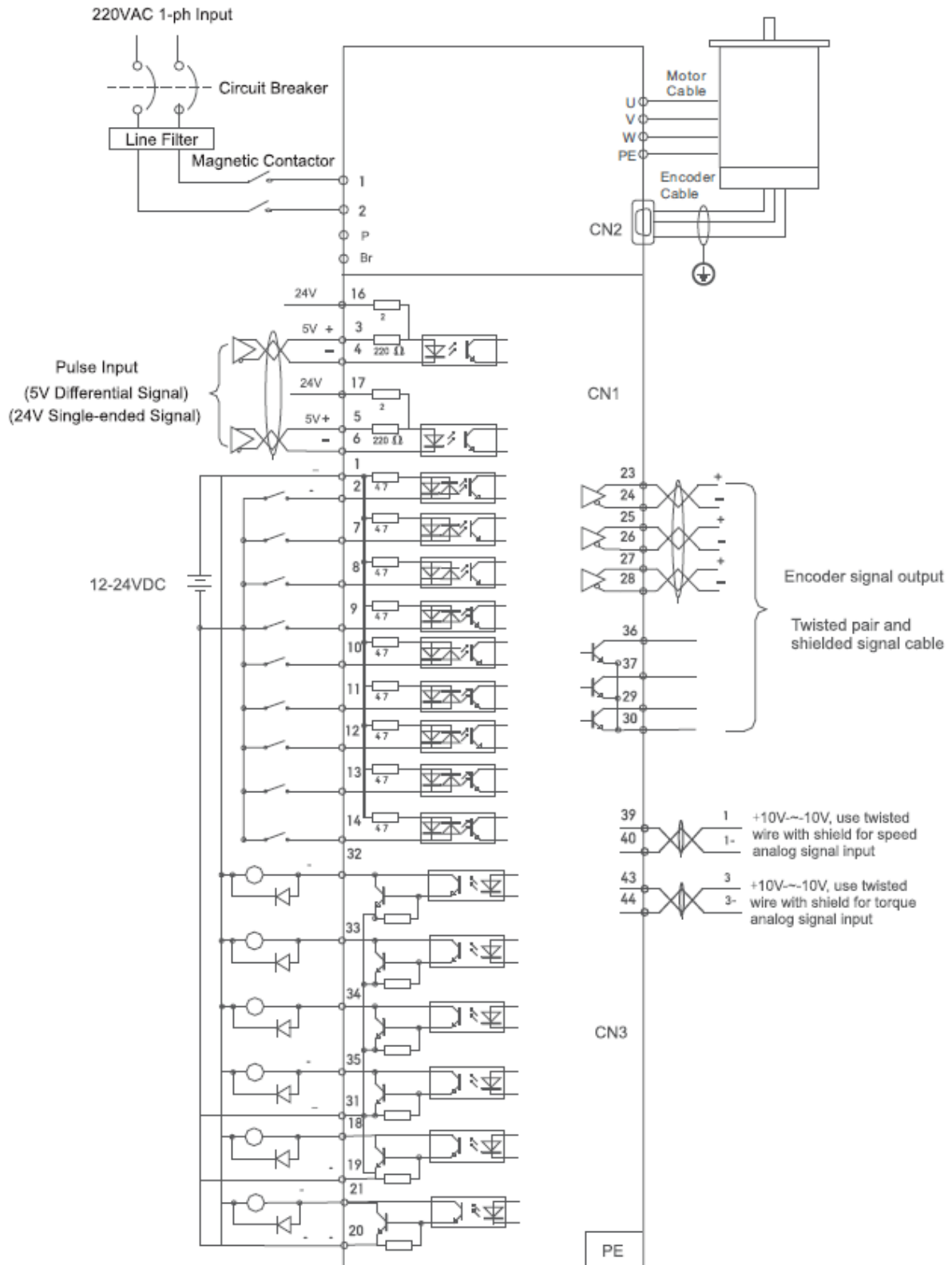

Figure 8-3 Velocity Mode Typical Wiring Diagram

Note: For drive is more than 1.5kw, 3 phases is better than single phase, connect L1, L2, L3

Notice: Analog input for Torque/Velocity mode is only available for ELP-RS***Z

Pls do inspection before velocity control test run
Related parameters setup of velocity mode

8.2.1 Velocity Control by Analog Command

Table 8.3 Parameter Setup of Velocity Controlled By Analog Input

No.	Parameter	Name	Input	Setup Value	Unit
1	Pr0.01	Control mode setup	/	1	/
2	Pr3.12	Acceleration time setup	/	User-specified	millisecond
3	Pr3.13	Deceleration time setup	/	User-specified	millisecond
4	Pr3.14	Sigmoid acceleration/deceleration time setup	/	User-specified	millisecond
5	Pr3.15	Zero speed clamping function select	/	2	/
6	Pr3.00	Velocity setup internal and external switching	/	0	/
7	Pr3.01	Speed Command direction selection	/	User-specified	/
8	Pr3.02	Speed command input gain	/	User-specified	Rpm/V
9	Pr3.03	Speed setting input reversal	/	User-specified	/
10	Pr4.22	Analog input I(AI1) offset setup	/	User-specified	0.359mv
11	Pr4.23	Analog input I(AI1) filter	/	User-specified	0.01ms
12	Pr4.00	SI1 input select: servo-enable		Hex:0003	/

◆ Wiring Diagram

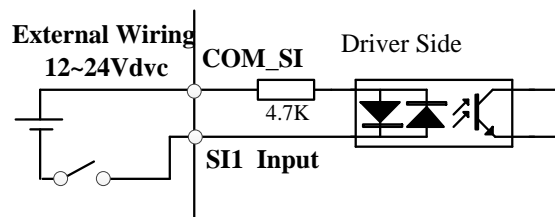

Digital Input for Servo Enable

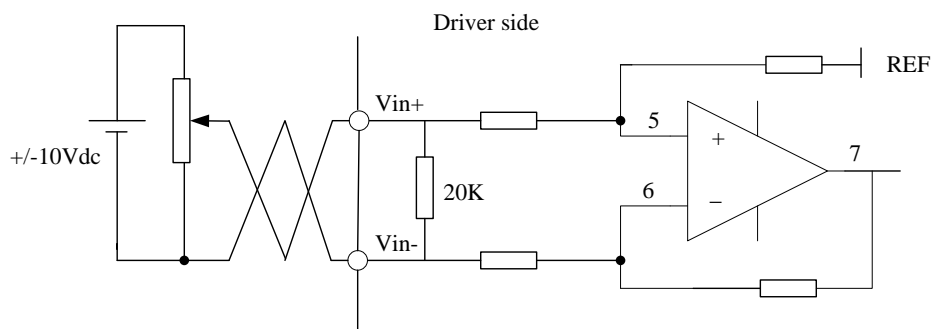

Analog Input for Velocity Control

Notice: Analog input for Torque/Velocity mode is only available for ELP-RS***Z

Pls do inspection before velocity control test run.

◆ Operation steps

1. Connect terminal CN1.
2. Enter the power (DC12V to 24V) to control signal (the COM_I and DI3).
3. Enter the power to the drive.
4. Confirm the value of the parameters, and write to the EEPROM and turn off/on the power (of the drive)

5. Connect the “Srv_on” input to enable drive and energize the motor.
6. Input DC voltage between velocity command input, AI1+ and AI1-, and increase input voltage.
7. Check the motor rotational speed at monitor mode, (“d01SP”)

Whether rotational speed is as setup or Not, and whether the motor stops with zero command or Not

8. When you want to change the rotational speed and direction, set up the following parameters again.

Pr3.00. Pr3.01. Pr3.03

If the motor does Not run correctly, refer to the Factor of No.-Motor running in data monitor mode (“d17Ch”).

The analog speed command input voltage is converted to equivalent digital speed command. You can set the filter to eliminate noise or adjust the offset.

Pr3.00	Name	Speed setup, Internal /External switching			Mode	V
	Range	0~3	Unit	—	Default	0
	Data length	16bit	Access	R/W	Address	0x 0301
	Effective	Immediate				
This drive is equipped with internal speed setup function so that you can control the speed with contact inputs only.						
Setup Value		Speed Setup Method				
0		Analog speed command(SPR)				
1		Internal speed command 1st to 4th speed(Pr3.04-Pr3.07)				
2		Internal speed command 1st to 3rd speed (Pr3.04-Pr3.06), Analog speed command(SPR)				
3		Internal speed command 1st to 8th speed (Pr3.04-Pr3.11)				
<relationship between Pr3.00 Internal/External switching speed setup and the internal command speed selection 1-3 and speed command to be selected>						
Setup Value	1st Selection Of Internal Command Speed (Intspd1)	2nd Selection Of Internal Command Speed (Intspd2)	3rd Selection Of Internal Command Speed (Intspd3)	Selection Of Speed Command		
1	OFF	OFF	NO. effect	1st speed		
	ON	OFF		2nd speed		
	OFF	ON		3rd speed		
	ON	ON		4th speed		
2	OFF	OFF	NO. effect	1st speed		
	ON	OFF		2nd speed		
	OFF	ON		3rd speed		
	ON	ON		Analog speed command		
3	The same as [Pr3.00=1]		OFF	1st to 4th speed		
	OFF	OFF	ON	5th speed		
	ON	OFF	ON	6th speed		
	OFF	ON	ON	7th speed		
	ON	ON	ON	8th speed		

Pr3.01	Name	Speed command rotational direction selection		Mode	V	
	Range	0~1	Unit	—	Default	0
	Data length	16bit	Access	R/W	Address	0x 0303
	Effective	Immediate				
Select the Positive /Negative direction specifying method						
		Setup Value	Velocity Value	Velocity Command Signal(VC-SIGN)	Velocity Command Direction	
		0	+	No. effect	Positive direction	
			-	No. effect	Negative direction	
		1	Sign Not effect	OFF	Positive direction	
			Sign Not effect	ON	Negative direction	

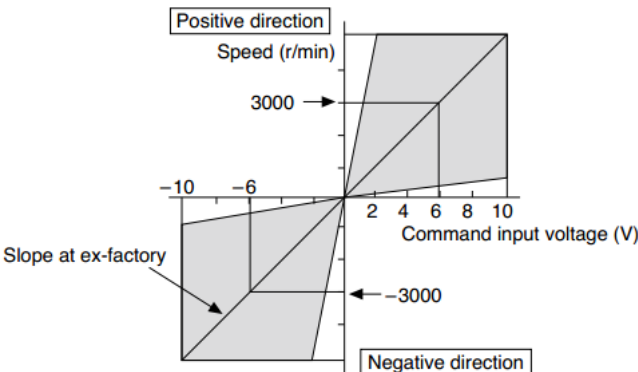
Pr3.02	Name	Input gain of speed command		Mode	V	
	Range	10~2000	Unit	(r/min)/V	Default	500
	Data length	16bit	Access	R/W	Address	0x 0305
	Effective	Immediate				
<p>Based on the voltage applied to the analog speed command (SPR), set up the conversion gain to motor command speed. You can set up “slope” of relation between the command input voltage and motor speed, with Pr3.02. Default is set to Pr3.02=500(r/min)/V, hence input of 6V becomes 3000r/min.</p> <p>Notice:</p> <ol style="list-style-type: none"> 1. Do Not apply more than $\pm 10V$ to the speed command input(SCR). 2. When you compose a position loop outside of the drive while you use the drive in velocity control mode, the setup of Pr3.02 gives larger variance to the overall servo system. 3. Pay an extra attention to oscillation caused by larger setup of Pr3.02 						
						

Pr3.03	Name	Reversal of speed command input		Mode	V	
	Range	0~1	Unit	—	Default	1
	Data length	16bit	Access	R/W	Address	0x 0307
	Effective	Immediate				

Specify the polarity of the voltage applied to the analog speed command (SPR).

Setup Value	Motor Rotating Direction	
0	Standard	[+ voltage] → [+ direction] \ [- voltage] → [-direction]
1	Reversed	[+ voltage] → [- direction] \ [- voltage] → [+direction]

Caution: When you compose the servo drive system with this drive set to velocity control mode and external positioning unit, the motor might perform an abnormal action if the polarity of the speed command signal from the unit and the polarity of this parameter setup do Not match.

8.2.2 Velocity Mode Control by Internal Speed Command

Table 8.4 Parameter Setup of Velocity Controlled by Analog Input

No.	Parameter	Name	Input	Setup Value	Unit
1	Pr0.01	Control mode setup	/	1	/
2	Pr3.12	Acceleration time setup	/	User-specified	millisecond
3	Pr3.13	Deceleration time setup	/	User-specified	millisecond
4	Pr3.14	Sigmoid acceleration/deceleration time setup	/	User-specified	millisecond
5	Pr3.15	Zero speed clamping function select	/	2	/
6	Pr3.00	Velocity setup internal and external switching	/	3	/
7	Pr3.01	Speed Command direction selection	/	User-specified	/
10	Pr4.22	Analog input I(AI3) offset setup	/	User-specified	0.359mv
11	Pr4.23	Analog input I(AI3) filter	/	User-specified	0.01ms
12	Pr4.00	SI1 input select: servo-enable		Hex:0003	/

◆ Wiring Diagram

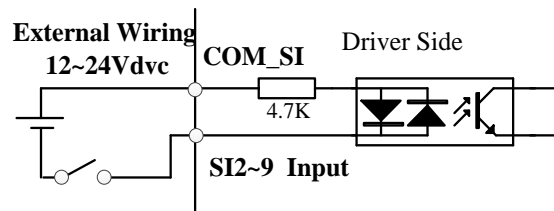
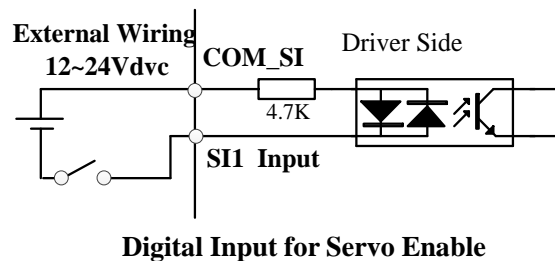

Digital Input for Velocity Control_ INTSPD1/ INTSPD2/ INTSPD3/ VC-SIGN

You can control the speed by using the internal speed command set to the parameter. By using the internal speed command selection 1, 2, 3(INTSPD 1, 2, 3), you can select best appropriate one

Pr3.00	Name	Speed setup, Internal /External	Mode	V
---------------	------	---------------------------------	------	----------

		switching				
	Range	0~3	Unit	—	Default	0
	Data length	16bit	Access	R/W	Address	0x 0301
	Effective	Immediate				

This drive is equipped with internal speed setup function so that you can control the speed with contact inputs only.

Setup Value	Speed Setup Method
0	Analog speed command(SPR)
1	Internal speed command 1st to 4th speed(Pr3.04-Pr3.07)
2	Internal speed command 1st to 3rd speed (Pr3.04-Pr3.06), Analog speed command(SPR)
3	Internal speed command 1st to 8th speed (Pr3.04-Pr3.11)

<relationship between Pr3.00 Internal/External switching speed setup and the internal command speed selection 1-3 and speed command to be selected>

Setup Value	1 st Selection Of Internal Command Speed (Intspd1)	2 nd Selection Of Internal Command Speed (Intspd2)	3 rd Selection Of Internal Command Speed (Intspd3)	Selection Of Speed Command
1	OFF	OFF	NO. effect	1st speed
	ON	OFF		2nd speed
	OFF	ON		3rd speed
	ON	ON		4th speed
2	OFF	OFF	NO. effect	1st speed
	ON	OFF		2nd speed
	OFF	ON		3rd speed
	ON	ON		Analog speed command
3	The same as [Pr3.00=1]		OFF	1st to 4th speed
	OFF	OFF	ON	5th speed
	ON	OFF	ON	6th speed
	OFF	ON	ON	7th speed
	ON	ON	ON	8th speed

Pr3.01	Name	Speed command rotational direction selection			Mode	v
	Range	0~1	Unit	—	Default	0
	Data length	16bit	Access	R/W	Address	0x 0303
	Effective	Immediate				

Select the Positive /Negative direction specifying method

Setup Value	Velocity Value	Velocity Command Signal(VC-SIGN)	Velocity Command Direction
0	+	No. effect	Positive direction
	-	No. effect	Negative direction
1	Sign Not effect	OFF	Positive direction
	Sign Not effect	ON	Negative direction

Pr3.02	Name	Input gain of speed command			Mode	V
	Range	10~2000	Unit	(r/min)/V	Default	500
	Data length	16bit	Access	R/W	Address	0x 0305
	Effective	Immediate				

Based on the voltage applied to the analog speed command (SPR), set up the conversion gain to motor command speed.
 You can set up “slope” of relation between the command input voltage and motor speed, with Pr3.02. Default is set to Pr3.02=500(r/min)/V, hence input of 6V becomes 3000r/min.

Notice:

1. Do Not apply more than $\pm 10V$ to the speed command input (SPR).
2. When you compose a position loop outside of the drive while you use the drive in velocity control mode, the setup of Pr3.02 gives larger variance to the overall servo system.
3. Pay an extra attention to oscillation caused by larger setup of Pr3.02

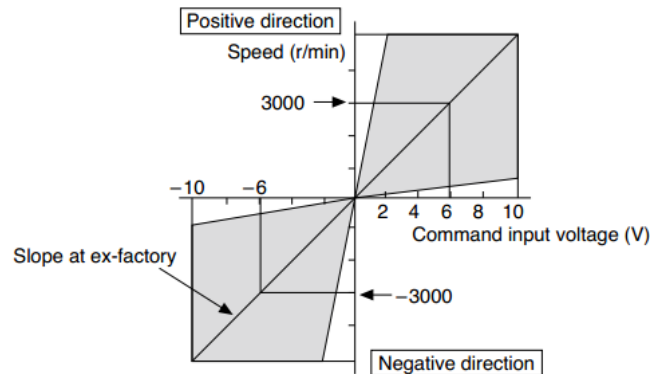

Pr3.03	Name	Reversal of speed command input			Mode	V
	Range	0~1	Unit	—	Default	1
	Data length	16bit	Access	R/W	Address	0x 0307
	Effective	Immediate				

Specify the polarity of the voltage applied to the analog speed command (SPR).

Setup Value	Motor Rotating Direction	
0	Standard	[+ voltage] → [+ direction] \ [- voltage] → [-direction]
1	Reversed	[+ voltage] → [- direction] \ [- voltage] → [+direction]

Caution: When you compose the servo drive system with this drive set to velocity control mode and external positioning unit, the motor might perform an abnormal action if the polarity of the speed command signal from the unit and the polarity of this parameter setup do Not match.

Pr3.04	Name	1st speed of speed setup			Mode	V
	Range	-10000~10000	Unit	r/min	Default	
	Data length	16bit	Access	R/W	Address	0x0309
	Effective	Immediate				
Pr3.05	Name	2nd speed of speed setup			Mode	V

	Range	-10000~10000	Unit	r/min	Default	
	Data length	16bit	Access	R/W	Address	0x 030B
	Effective	Immediate				
Pr3.06	Name	3rd speed of speed setup			Mode	<input checked="" type="checkbox"/>
	Range	-10000~10000	Unit	r/min	Default	
	Data length	16bit	Access	R/W	Address	0x 030D
	Effective	Immediate				
Pr3.07	Name	4th speed of speed setup			Mode	<input checked="" type="checkbox"/>
	Range	-10000~10000	Unit	r/min	Default	
	Data length	16bit	Access	R/W	Address	0x 030F
	Effective	Immediate				
Pr3.08	Name	5th speed of speed setup			Mode	<input checked="" type="checkbox"/>
	Range	-10000~10000	Unit	r/min	Default	
	Data length	16bit	Access	R/W	Address	0x 0311
	Effective	Immediate				
Pr3.09	Name	6th speed of speed setup			Mode	<input checked="" type="checkbox"/>
	Range	-10000~10000	Unit	r/min	Default	
	Data length	16bit	Access	R/W	Address	0x 0313
	Effective	Immediate				
Pr3.10	Name	7th speed of speed setup			Mode	<input checked="" type="checkbox"/>
	Range	-10000~10000	Unit	r/min	Default	
	Data length	16bit	Access	R/W	Address	0x 0315
	Effective	Immediate				
Pr3.11	Name	8th speed of speed setup			Mode	<input checked="" type="checkbox"/>
	Range	-10000~10000	Unit	r/min	Default	0
	Data length	16bit	Access	R/W	Address	0x 0317
	Effective	Immediate				
Set up internal command speeds, 1st to 8th						

8.2.3 Speed Command Acceleration and Deceleration

On the basis of speed command input, acceleration and deceleration are added as internal speed commands to control the speed. This function can be used when entering the ladder-like speed command and internal speed setting. In addition, the acceleration and deceleration function can also be used when the vibration is reduced by the change of acceleration

Pr3.12	Name	Time setup acceleration			Mode	<input checked="" type="checkbox"/>
	Range	0~10000	Unit	Ms/	Default	100

	Data length	16bit	Access	R/W	Address	0x 0319
	Effective	Immediate				
Pr3.13	Name	Time setup deceleration			Mode	V
	Range	0~10000	Unit	Ms/ (1000r/min)	Default	100
	Data length	16bit	Access	R/W	Address	0x 031B
	Effective	Immediate				

Set up acceleration/deceleration processing time in response to the speed command input.

Set the time required for the speed command(stepwise input)to reach 1000r/min to Pr3.12

Acceleration time setup. Also set the time required for the speed command to reach from 1000r/min to 0 r/min, to Pr3.13 deceleration time setup.

Assuming that the target value of the speed command is V_c (r/min), the time required for acceleration/deceleration can be computed from the formula shown below.

$$\text{Acceleration time (ms)} = V_c / 1000 * Pr3.12 * 1\text{ms}$$

$$\text{Deceleration time (ms)} = V_c / 1000 * Pr3.13 * 1\text{ms}$$

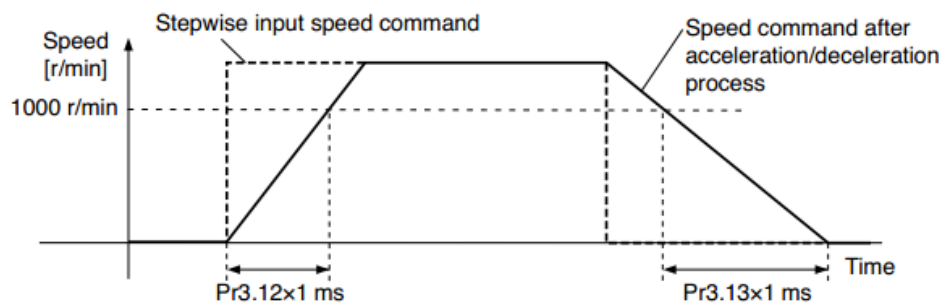

Pr3.14	Name	Sigmoid acceleration /deceleration time setup			Mode	V
	Range	0~1000	Unit	ms	Default	0
	Data length	16bit	Access	R/W	Address	0x 031D
	Effective	Power-on again				

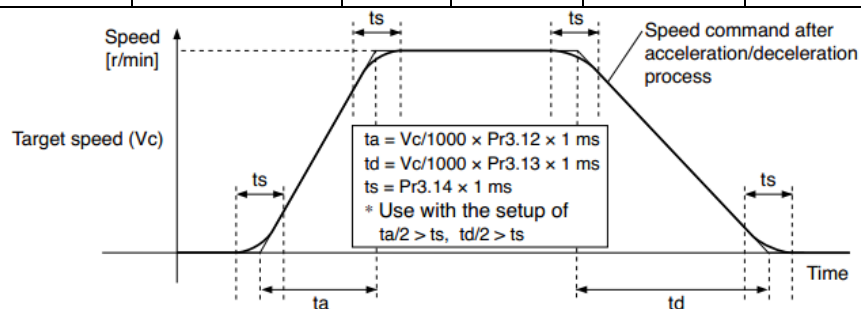

Set S-curve time for acceleration/deceleration process when the speed command is applied. According to Pr3.12 Acceleration time setup and Pr3.13 Deceleration time setup, set up sigmoid time with time width centering the inflection point of acceleration/deceleration.

8.2.4 Attained Speed Signal AT-SPEED Output

When the motor speed reaches the speed set by the parameter Pr_436 (setting of arrival speed), the output speed reaches the output (AT-SPEED) signal.

This function can be configured by IO output function parameters, as described in IO Pr4.10 parameters. When the speed meets the set conditions, the set corresponding output IO port can output ON.

Pr4.36	Name	At-speed(Speed arrival)			Mode	V
	Range	10~2000	Unit	r/min	Default	1000
	Data length	16bit	Access	R/W	Address	0x 0449
	Effective	Immediate				

Set the detection timing of the speed arrival output (AT-SPEED).
 When the motor speed exceeds this setup value, the speed arrive output (AT-SPEED) is output.
 Detection is associated with 10r/min hysteresis.

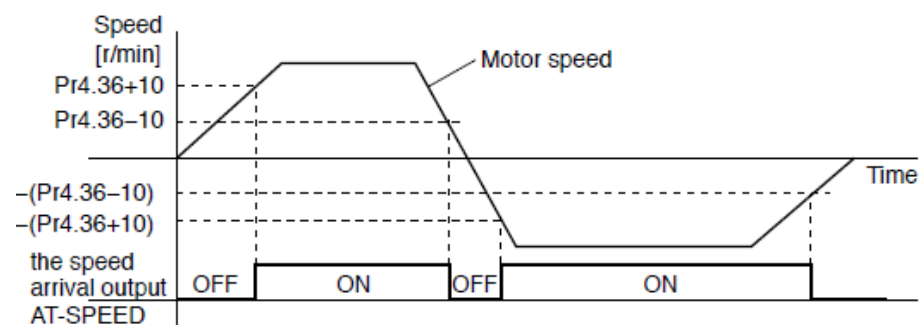

8.2.5 Speed Coincidence Output (V-COIN)

When the speed command (before acceleration and deceleration processing) is consistent with the motor speed, the output speed is consistent (V-COIN). If the difference between the speed command and the motor speed before acceleration and deceleration processing in the drive is within the parameter Pr_435 (setting the same speed range), it is judged to be consistent.

This function can be configured by IO output function parameters, as described in IO Pr4.10 parameters. When the speed difference meets the setting conditions, the corresponding output IO port set can output ON.

Among them, the in place signal of PV mode is synchronized with the v-coin signal

Pr4.35	Name	Speed coincidence range			Mode	V
	Range	10~2000	Unit	r/min	Default	50
	Data length	16bit	Access	R/W	Address	0x 0447
	Effective	Immediate				

Set the speed coincidence (V-COIN) output detection timing.
Output the speed coincidence (V-COIN) when the difference between the speed command and the motor speed is equal to or smaller than the speed specified by this parameter.

Because the speed coincidence detection is associated with 10 r/min hysteresis, actual detection range is as shown below.

Speed coincidence output OFF -> ON timing (Pr4.35 -10) r/min

Speed coincidence output ON -> OFF timing (Pr4.35 +10) r/min

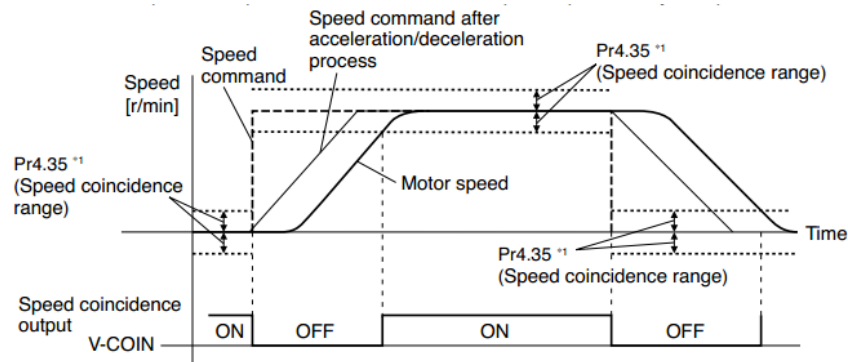

8.2.6 Zero-Speed Clamp (ZEROSPD)

You can forcibly set the speed command to 0 by using the speed zero clamp input.

Pr3.15	Name	Speed zero-clamp function selection			Mode	V
	Range	0~3	Unit	0.1HZ	Default	0
	Data length	16bit	Access	R/W	Address	0x 031F
	Effective	Immediate				

1. If Pr3.15=0, the function of zero clamp is forbidden. It means the motor rotates with actual velocity which is controlled by the analog voltage input 1 even if the velocity is less than 10 rpm. The motor runs No. matter what the value of Pr3.16 is. The actual velocity is controlled by external the analog voltage input.
2. If Pr3.15=1 and the input signal of Zero Speed is available in the same time, the function of zero clamp works. It means motor will stop rotating in servo-on condition No. matter what the velocity of motor is, and motor stop rotating No. matter what the value of Pr3.16 is.
3. If Pr3.15=2, the function of zero clamp belongs to the value of Pr3.16. If the actual velocity is less than the value of Pr3.16, the motor will stop rotating in servo-on condition.

Pr3.16	Name	Speed zero-clamp level			Mode	V
	Range	10~2000	Unit	r/min	Default	30
	Data length	16bit	Access	R/W	Address	0x 0321
	Effective	Immediate				

When analog speed command value less than speed zero-clamp level setup, actual speed will set to 0.

Other setup for SI/SO function

For details of SI input function, refer to Pr4.00 – Pr4.09.

For details of SO output function, refer to Pr4.10 – Pr4.15.

8.3 Torque Control

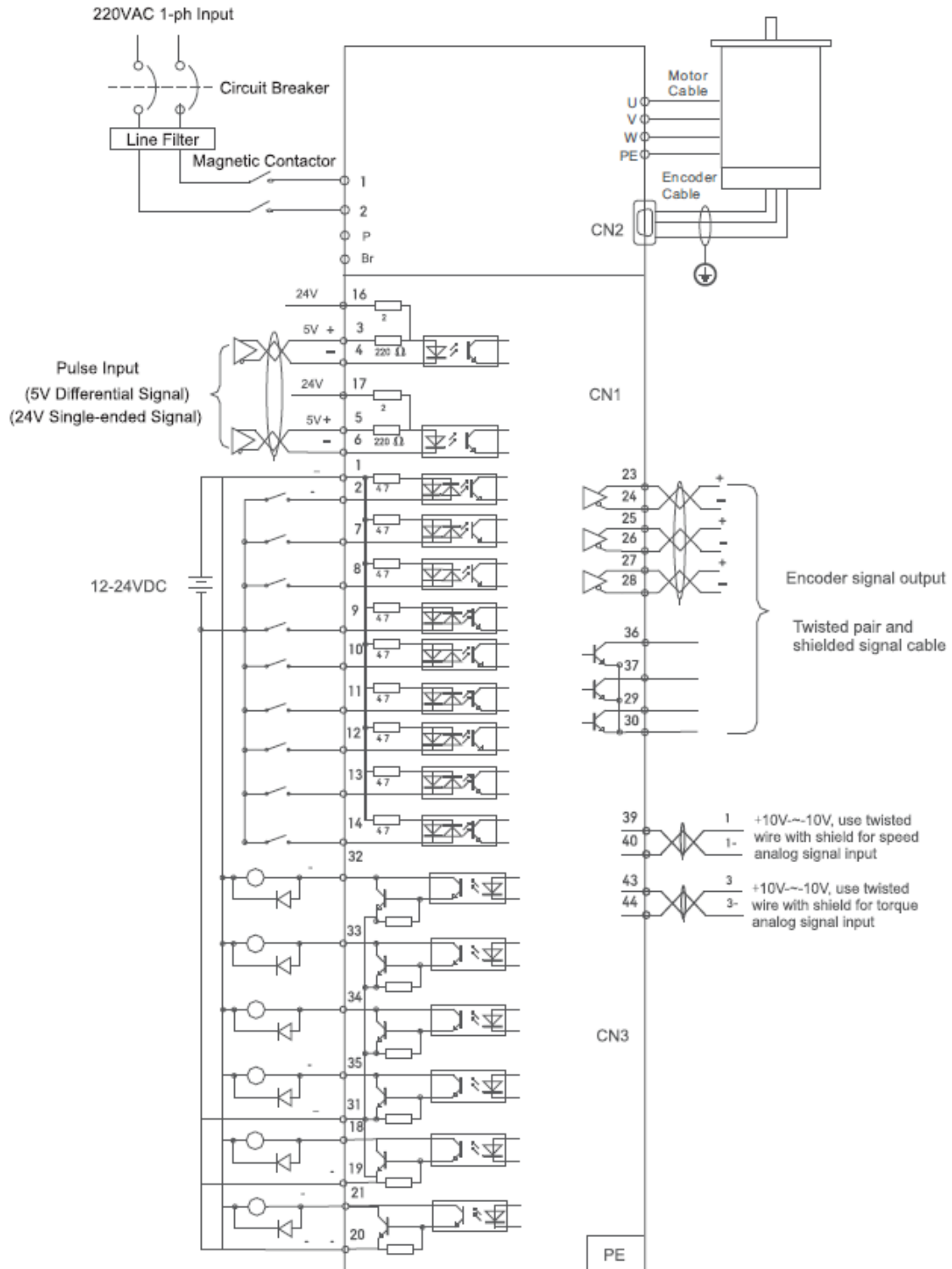

Figure 8-4 Torque Mode Typical External Wiring Diagram

Note: For drive is more than 1.5kw, 3 phases is better than single phase, connect L1, L2, L3

Notice: Analog input for Torque/Velocity mode is only available for ELP-RS***Z

Pls do inspection before velocity control test run

8.3.1 Torque Mode Control by Analog Command Input

The analog torque command input voltage is converted to equivalent digital torque command. You can set the filter to eliminate Noise or adjust the offset. The torque control is performed according to the torque command specified in the form of analog voltage. For controlling the torque, the speed limit input is required in addition to the torque command to maintain the motor speed within the speed limit.

Table 8.6 Parameter Setup of Torque Control

No.	Parameter	Name	input	Setup value	Unit
1	Pr0.01	Control mode setup	/	2	/
6	Pr3.17	Selection of torque command	/	0	/
	Pr3.18	Torque command direction selection			
7	Pr3.19	Torque command direction input gain	/	User-specified	0.1V/100%
8	Pr3.20	Torque setup input reversal	/	User-specified	/
9	Pr3.21	Speed limit value 1	/	User-specified	r/min
	Pr3.22	Torque limit value in torque mode control.	/		%
10	Pr4.00	SI1 input select: servo-enable	Srv_on	hex:030000	/

◆ Wiring Diagram

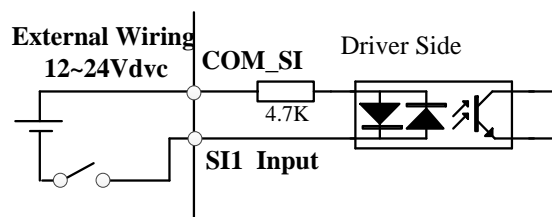

Digital Input for Servo Enable

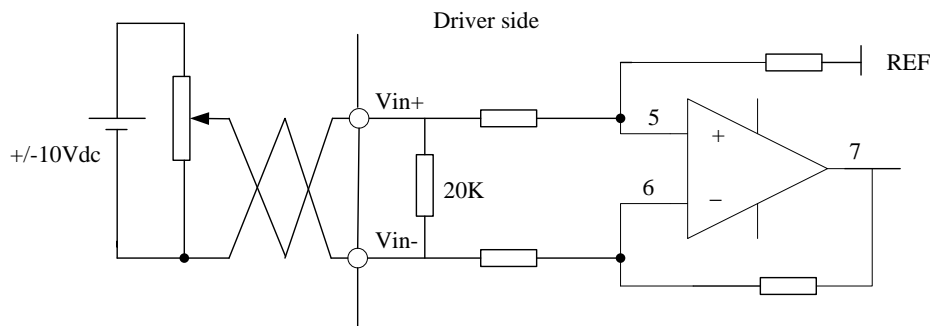

Analog Input for Torque Control

Notice: Analog input for Torque/Velocity mode is only available for ELP-RS***Z

Pls do inspection before velocity control test run.

◆ Operation Steps

1. Connect terminal CN1.
2. Enter the power (DC12V to 24V) to control signal (the COMI + and DI1).
3. Enter the power to the drive.
4. Confirm the value of the parameters, and write to the EEPROM and turn off/on the power (of the drive)

5. Connect the “Srv_on” input to enable drive and energize the motor.
6. Input DC voltage between torque command input, VIN+ and VIN-, and increase input voltage.
7. Check the motor torque at monitor mode (“d04tr”), whether actual torque as setup or Not
8. When you want to change the torque magnitude, direction and velocity limit value against the command voltage, set up the following parameters : Pr3.19. Pr3.20. Pr3.21

If the motor does Not run correctly, refer to the Factor of No.-Motor running in data monitor mode (“d17Ch”).

Related parameters setup of torque control mode.

Pr3.17	Name	Selection of torque command			Mode		T															
	Range	0/1/2	Unit		Default	0																
	Data length	16bit	Access	R/W	Address	0x 0323																
	Effective	Immediate																				
<table border="1" style="width: 100%; border-collapse: collapse;"> <thead> <tr> <th>Setup value</th> <th>Torque command input</th> <th>Velocity limit input</th> </tr> </thead> <tbody> <tr> <td>0</td> <td>Analog input 3</td> <td>Parameter value (P3.21)</td> </tr> <tr> <td>1</td> <td>Analog input 3</td> <td>Analog input 1 for Speed limit</td> </tr> <tr> <td>2</td> <td>Parameter value (P3.22)</td> <td>Parameter value (P3.21)</td> </tr> <tr> <td>3</td> <td>Analog input 3</td> <td>Speed limit 0</td> </tr> </tbody> </table>								Setup value	Torque command input	Velocity limit input	0	Analog input 3	Parameter value (P3.21)	1	Analog input 3	Analog input 1 for Speed limit	2	Parameter value (P3.22)	Parameter value (P3.21)	3	Analog input 3	Speed limit 0
Setup value	Torque command input	Velocity limit input																				
0	Analog input 3	Parameter value (P3.21)																				
1	Analog input 3	Analog input 1 for Speed limit																				
2	Parameter value (P3.22)	Parameter value (P3.21)																				
3	Analog input 3	Speed limit 0																				

Pr3.18	Name	Torque command direction selection			Mode		T						
	Range	0~1	Unit	—	Default	0							
	Data length	16bit	Access	R/W	Address	0x 0325							
	Effective	Immediate											
Select the direction positive/negative direction of torque command													
<table border="1" style="width: 100%; border-collapse: collapse;"> <thead> <tr> <th style="width: 20%;">Setup Value</th> <th>Details</th> </tr> </thead> <tbody> <tr> <td style="text-align: center;">0</td> <td>Specify the direction with the sign of torque command Torque command input[+] → positive direction, [-] → negative direction</td> </tr> <tr> <td style="text-align: center;">1</td> <td>Specify the direction with torque command sign(TC-SIGN). OFF: positive direction ON: negative direction</td> </tr> </tbody> </table>								Setup Value	Details	0	Specify the direction with the sign of torque command Torque command input[+] → positive direction, [-] → negative direction	1	Specify the direction with torque command sign(TC-SIGN). OFF: positive direction ON: negative direction
Setup Value	Details												
0	Specify the direction with the sign of torque command Torque command input[+] → positive direction, [-] → negative direction												
1	Specify the direction with torque command sign(TC-SIGN). OFF: positive direction ON: negative direction												

Pr3.19	Name	Torque command input gain			Mode		T
	Range	10~100	Unit	0.1V/100%	Default	0	
	Data length	16bit	Access	R/W	Address	0x 0327	
	Effective	Immediate					

Based on the voltage (V) applied to the analog torque command (TRQR), set up the conversion gain to torque command(%)

- Unit of the setup value is 0.1V/100% and set up input voltage necessary to produce the rated torque.
- Default setup of 30 represents 3V/100%

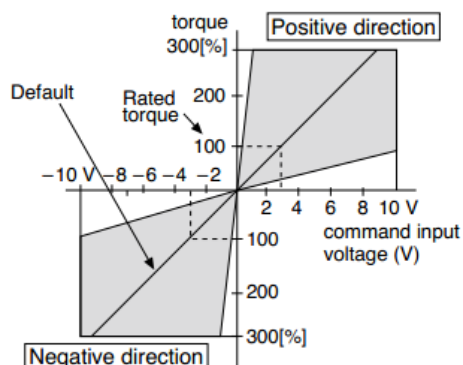

Pr3.20	Name	Torque command input reversal		Mode		T
	Range	0~1	Unit	—	Default	0
	Data length	16bit	Access	R/W	Address	0x 0329
	Effective	Immediate				
Set up the polarity of the voltage applied to the analog torque command (TRQR).						
Setup Value		Direction Of Motor Output Torque				
0		Non-reversal	[+ voltage] → [+ direction] [- voltage] → [-direction]			
1		reversal	[+ voltage] → [- direction] [- voltage] → [+direction]			

8.3.2 Torque Limit Function

The speed limit is one of protective functions used during torque control. This function regulates the motor speed so that it doesn't exceed the speed limit while the torque is controlled.

Pr3.20	Name	Torque command input reversal		Mode		T
	Range	0~1	Unit	—	Default	0
	Data length	16bit	Access	R/W	Address	0x 0329
	Effective	Immediate				
Set up the polarity of the voltage applied to the analog torque command (TRQR).						
Setup Value		Direction Of Motor Output Torque				
0		Non-reversal	[+ voltage] → [+ direction] [- voltage] → [-direction]			
1		reversal	[+ voltage] → [- direction] [- voltage] → [+direction]			

Pr3.21	Name	Speed limit value 1		Mode		T
	Range	0~10000	Unit	r/min	Default	0

	Data length	16bit	Access	R/W	Address	0x 032B
	Effective	Immediate				
Set up the speed limit used for torque control. During the torque controlling, the speed set by the speed limit cannot be exceeded.						

Other setup for SI/SO function

For details of SI input function, refer to Pr400 – Pr409.

For details of SO output function, refer to Pr10 – Pr415.

8.4 Inertia Ratio Identification

Pr0.04	Name	Inertia ratio			Mode	P	V	T
	Range	0~10000	Unit	%	Default	250		
	Data length	16bit	Access	R/W	Address	0x 0009		
	Effective	Immediate						
You can set up the ratio of the load inertia against the rotor (of the motor) inertia. Pr0.04=(load inertia/rotate inertia) ×100% Notice: If the inertia ratio is correctly set, the setup unit of Pr1.01 and Pr1.06 becomes (Hz). When the inertia ratio of Pr0.04 is larger than the actual value, the setup unit of the velocity loop gain becomes larger, and when the inertia ratio of Pr0.04 is smaller than the actual value, the setup unit of the velocity loop gain becomes smaller.								

8.4.1 On-Line Inertia Ratio Identification

The motor is operated by the controller, and the motor speed is above 400rpm. The running stroke has obvious acceleration, uniform speed and deceleration process, and the load inertia ratio can be tested by running 2-3 times continuously. The inertia ratio of the test is viewed in drive Operating Data Monitor-> d16Jr. Set the monitor value into Pr0.04.

8.4.2 Off-Line Inertia Ratio Identification

Pre-conditions: 1. Servo disable. 2. Positive limit and negative limit invalid

Steps:

1. Set the trial running speed Pr6.04, and the setting of Pr6.04 should Not be too large
2. Enter auxiliary inertia ratio identification function on the drive panel, AF_GL
3. Press ENT once to enter operation, display “G---”
4. Press ◀ once, display “StUon”
5. Press ▲ once, motor start running to identification
6. After finishing, display G XXX, which represents the measured inertia ratio value
7. Set the monitor value minus 100 into Pr0.04.

8.4.3 Motion Studio Inertia Ratio Identification

This inertia ratio identification function also added in Motion Studio configuration software.

Pre-conditions: 1. Servo disable. 2. Positive limit and negative limit invalid

Steps:

1. Set the Jog speed Pr6.04, and the setting should Not be too large(600~1000rpm is recommend)
Set the Acc Pr6.25 (50~100 ms/1000rpm is recommend)
Set the Default Inertia Ratio.

Download these settings, then **Servo Enable**.

2. Click “CCW” to make motor run to CCW direction, click “Position 1” to save the position limit 1
Click “CW” to make motor run to CW direction, click “Position 2” to save the position limit 2
Click “Run” to start Inertia ratio identification.

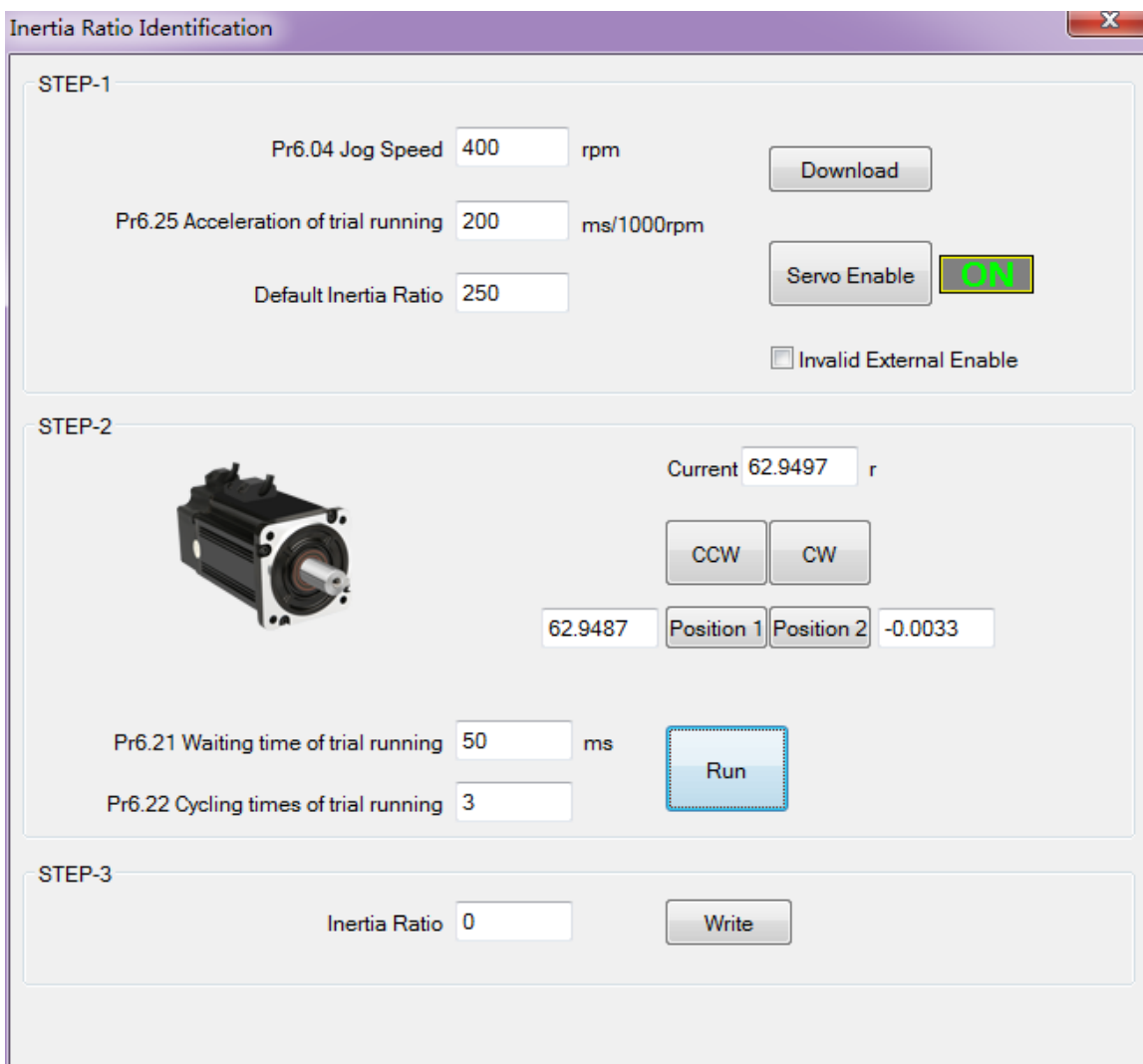

Inertia Ratio Identification

STEP-1

Pr6.04 Jog Speed rpm

Pr6.25 Acceleration of trial running ms/1000rpm **ON**

Default Inertia Ratio Invalid External Enable

STEP-2

 Current r

Pr6.21 Waiting time of trial running ms

Pr6.22 Cycling times of trial running

STEP-3

Inertia Ratio

3. After finishing, Click“Write”to save the Inertia ratio identification result.

8.5 Vibration Suppression

Specific resonance frequency can be obtained from PC upper computer software according to waveform

monitoring, and filter frequency can be set to effectively suppress the oscillation ripple of a certain frequency in the current instruction.

The width of the Notch is the ratio of the frequency of the Notch center at a depth of 0 to the frequency range width of the attenuation rate of -3db.

The depth of the trap is: when the set value is 0, the input of the center frequency is completely disconnected; when the set value is 100, it represents the ratio of input and output that are completely passed

How to use:

1. Set Pr2.00=1
2. Decrease Pr0.03 to get higher stiffness, higher position loop gain and velocity loop gain. Decrease Pr0.03 gradually, while abnormal sound or oscillation occurred, decreases the current value by 2.
3. Execute movement by controller or Motion Studio, drive will record Notch frequency automatically.
4. Upload the drive parameters, the record Notch frequency saved in Pr2.07.
Read the value of Pr2.07, and set this value into Pr2.01. Then reset Pr2.07 to 2000.
5. Saving parameters setting.

Pr2.00	Name	Adaptive filter mode setup			Mode	P	V	
	Range	0~4	Unit	—	Default	0		
	Data length	16bit	Access	R/W	Address	0x 0201		
	Effective	Immediate						
Set up the resonance frequency to be estimated by the adaptive filter and the special the operation after estimation.								
Setup Value		Details						
0	Adaptive filter: invalid	Parameters related to the 3rd and 4th Notch filter hold the current value.						
1	Adaptive filter, 1 filter is valid, one time	One adaptive filter is valid, parameters related to the 3rd Notch filter will be updated based on adaptive performance. After updated, Pr2.00 returns to 0, stop self-adaptation.						
2	Adaptive filter, 1 filter is valid, It will be valid all the time	One adaptive filter is valid, parameters related to the 3rd Notch filter will be updated all the time based on adaptive performance.						
3-4	Not use	Forbid Non-professional to use						

Pr2.01	Name	1st notch frequency			Mode	P	V	T
	Range	50~2000	Unit	Hz	Default	2000		
	Data length	16bit	Access	R/W	Address	0x 0203		
	Effective	Immediate						
Set the center frequency of the 1st Notch filter Notice: the Notch filter function will be invalid by setting up this parameter to “2000”.								
Pr2.02	Name	1st notch width selection			Mode	P	V	T
	Range	0~20	Unit	—	Default	2		
	Data length	16bit	Access	R/W	Address	0x 0205		
	Effective	Immediate						

Set the width of Notch at the center frequency of the 1st Notch filter.

Notice: Higher the setup, larger the Notch width you can obtain. Use with default setup in Normal operation.

Pr2.03	Name	1st notch depth selection			Mode	P	V	T
	Range	0~99	Unit	—	Default	0		
	Data length	16bit	Access	R/W	Address	0x 0207		
	Effective	Immediate						

Set the depth of Notch at the center frequency of the 1st Notch filter.

Notice: Higher the setup, shallower the Notch depth and smaller the phase delay you can obtain.

Pr2.04	Name	2nd notch frequency			Mode	P	V	T
	Range	50~2000	Unit	Hz	Default	2000		
	Data length	16bit	Access	R/W	Address	0x 0209		
	Effective	Immediate						

Set the center frequency of the 2nd Notch filter

Notice: the Notch filter function will be invalid by setting up this parameter to “2000”.

Pr2.05	Name	2nd notch width selection			Mode	P	V	T
	Range	0~20	Unit	—	Default	2		
	Data length	16bit	Access	R/W	Address	0x 020B		
	Effective	Immediate						

Set the width of Notch at the center frequency of the 2nd Notch filter.

Notice: Higher the setup, larger the Notch width you can obtain. Use with default setup in Normal operation.

Pr2.06	Name	2nd notch depth selection			Mode	P	V	T
	Range	0~99	Unit	—	Default	0		
	Data length	16bit	Access	R/W	Address	0x 020D		
	Effective	Immediate						

Set the depth of Notch at the center frequency of the 2nd Notch filter.

Notice: Higher the setup, shallower the Notch depth and smaller the phase delay you can obtain.

8.6 Third Gain Switching

In addition to the conventional switch between the first and second gain, add the third gain switch function to shorten the positioning and setting time.

Pr6.05	Name	Position 3 rd gain valid time			Mode	P		
	Range	0~1000	Unit	0.1ms	Default	0		
	Data length	16bit	Access	R/W	Address	0x 060B		

Effective	Immediate				
Set up the time at which 3 rd gain becomes valid. When Not using this parameter, set Pr6.05=0, Pr6.06=100 This is valid for only position control/full-closed control.					

Pr6.06	Name	Position 3 rd gain multiplication			Mode	P
	Range	0~1000	Unit	100%	Default	0
	Data length	16bit	Access	R/W	Address	0x 060D
	Effective	Immediate				
Set up the 3 rd gain by multiplying factor of the 1 st gain $3\text{rd gain} = 1\text{st gain} \times \text{Pr6.06}/100$.						

This function is only effective for position control. When Pr6.06 is set to Non-0 value, the third gain function will be turned on. Pr6.05 is set to specify the value of the third gain. When switching from the second gain to the first gain, there will be a transition from the third gain. The switching time is set as Pr1.19. Take Pr1.15=7(with or without position instruction as the first and second gain of conditional switching) as an example to illustrate the figure below:

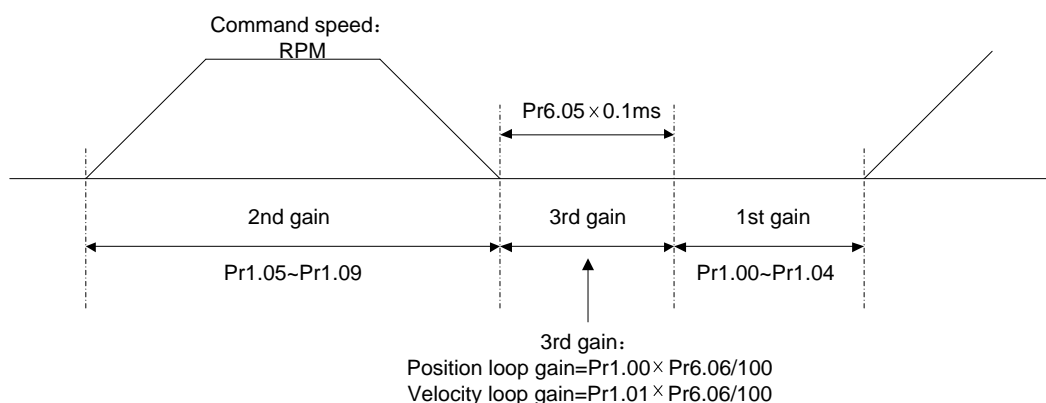

8.7 Friction Torque Compensation

Pr6.07	Name	Torque command additional value			Mode	P	V	T
	Range	-100~100	Unit	%	Default	0		
	Data length	16bit	Access	R/W	Address	0x 060F		
	Effective	Immediate						
Pr6.08	Name	Positive torque compensation value			Mode	P	V	T
	Range	-100~100	Unit	%	Default	0		
	Data length	16bit	Access	R/W	Address	0x 0611		
	Effective	Immediate						
Pr6.09	Name	Negative torque compensation value			Mode	P	V	T
	Range	-100~100	Unit	%	Default	0		

	Data length	16bit	Access	R/W	Address	0x 0613
	Effective	Immediate				
These three parameters may apply feed forward torque superposition directly to torque command.						

8.8 Regenerative Resister Setting

When the torque of the motor is opposite to the direction of rotation (such as deceleration, z-axis falling down, etc.), energy will feedback to the drive. At this time, the energy feedback received by the capacitor in the drive, which makes the voltage of the capacitor rise. When it rises to a certain voltage value, the excess energy needs to be consumed by the regenerative resistance.

8.9 Security Features

Pr0.16	Name	External regenerative resistance			Mode	P	V	T
	Range	10~50	Unit	Ω	Default	100		
	Data length	16bit	Access	R/W	Address	0x 0021		
	Effective	Immediate						
Set Pr.0.16 and Pr.0.17 to confirm the threshold value of the discharge loop to give alarm for over current.								

Pr0.17	Name	External regenerative resistor power value			Mode	P	V	T
	Range	0~10000	Unit	W	Default	20		
	Data length	16bit	Access	R/W	Address	0x 0023		
	Effective	Immediate						
Set Pr.0.16 and Pr.0.17 to confirm the threshold value of the discharge loop to give alarm for over current.								

8.9.1 Speed Limit

Pr3.24 *	Name	Motor rotate maximum speed limit			Mode	P	V	T
	Range	0~10000	Unit	r/min	Default	3000		
	Data length	16bit	Access	R/W	Address	0x 0331		
	Effective	Immediate						
Set up motor running max rotate speed, but can't be exceeded motor allowed max rotate speed.								

8.9.2 Torque Limit (TL-SEL)

Pr5.21	Name	Selection of torque limit			Mode	P	V	T
	Range	0~5			Unit	—	Def aul t	0
	Data length	16bit			Access	R/ W	Ad dre ss	0x 052 B
	Effective	Immediate						

Set up the torque limiting method

Setup Value		Limiting Value	
0		Pr0.13	
1		Pr5.22	
2	TL-SEL off	Pr0.13	
	TL-SEL on	Pr5.22	
5		Pr0.13 Positive torque limit Pr5.22 Negative torque limit	

Pr5.22	Name	2nd torque limit			Mode	P	V	T
	Range	0~500	Unit	%	Default	300		
	Data length	16bit	Access	R/W	Address	0x 052D		
	Effective	Immediate						

Set up the 2nd limit value of the motor torque output

The value of the parameter is limited to the maximum torque of the applicable motor.

Pr0.13	Name	1st torque limit			Mode	P	V	T
	Range	0~500	Unit	%	Default	300		
	Data length	16bit	Access	R/W	Address	0x 001B		
	Effective	Immediate						

You can set up the limit value of the motor output torque, as motor rate current %, the value can't exceed the maximum of output current.

8.10 Multi-Turn Absolute Encoder

The absolute encoder remember position, When the absolute encoder is used for the first time, user need to move to the home position, and clear the absolute position value of multiple turns through the drive to set the home position. It is unnecessary to return to home position in the future (except for the absolute encoder alarm and other situations). It is recommended that the motor is stationary when reading the position to prevent dynamic data jump.

8.10.1 Parameters Setting

Pr0.15	Name	Absolute encoder setup			Mode	P	V	T
	Range	0~15	Unit		Default	0		
	Data length	16bit	Access	R/W	Address	0x 001F		

	Effective	Power-on again			
--	-----------	----------------	--	--	--

How to use:

0: Incremental position mode:
The encoder is used as a incremental encoder, and the position retentive at power failure is Not supported.

1: Absolute position linear mode:
The encoder is used as an absolute encoder, and the position retentive at power failure is supported.
It is applicable to the scenario where the travel range of device load is fixed and the encoder multi-turn data dose Not overflow.

2: Absolute position rotation mode:
The encoder is used as an absolute encoder, and the position retentive at power failure is supported.
It is mainly applicable to the scenario where the load travel range is Not limited and the number of motor single-direction revolution is less than $0\sim(\text{Pr}6.63+1)$

5: Clean multi-turn alarm, and open multi-turn absolute function.
It will become 1 when Normal clearance, if it's still 5 after 3seconds, please deal with according to 153 alarm processing.

9: Clear multi-turn position and reset multi-turn alarm, open multi-turn absolute function.
It will become 1 when Normal clearance, if it's still 9 after 3seconds, please deal with according to 153 alarm processing. Please remember to do mechanical homing.

Notes: Set to 9 after homing process finished and servo disabled, valid after Effective.

8.10.2 Read Absolute Position

1. Steps:

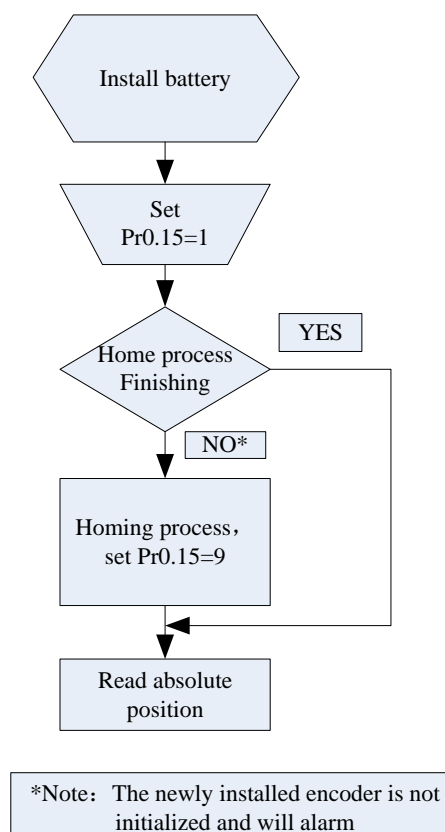

(1) Firstly, select the multi-turns absolute encoder motor, install the battery, and confirm whether the drive version supports multi-turns absolute encoder motor;

(2) Set Pr0.15=1 to open absolute encoder. If it is the first time of installation, the drive will alarm Err153. The reason is that the multi-turn position is invalid due to the newly installed battery of the motor. At this time, it is necessary to return to the home position of the machine and perform the multi-turn position reset operation (see multi-turn position reset).

(3) When the absolute value origin is set and there is No. battery fault, the alarm will be cancelled

(4) Finally, the user can read the absolute position, even if the power off the position will Not lost.

2. Read absolute position

The absolute encoder counting mode is that when the motor rotates clockwise, the number of turns is defined as negative; while motor rotates counterclockwise the number of turns is defined as positive. The maximum rotation number is -32768 to +32767. After the number of turns is out of range, if the number of turns is 32767 counterclockwise, it will reverse to -32768, -32767... ; If the number of turns clockwise -32768, it will reverse to 32767, 32766...

Absolute encoder read mode: read 6064h data object

3. Clear absolute position

Before clear absolute position, the machine needs to return to the home point. After clear absolute position, the absolute position =0, the single-turn position remains unchanged, and the absolute value of the encoder is cleared to alarm

Set Pr0.15=9: multi-turn zero clearing and reset multi-turn alarm, open multi-turn absolute function. It will become 1 when Normal clearance, if it's still 9 after 3seconds, please deal with according to 153 alarm processing. Please remember to do mechanical homing.

8.10.3 Alarm

1. Introductions

The multi-turns absolute encoder alarm function can determine whether the absolute encoder is valid or Not, such as battery under voltage or power failure, encoder fault, etc., users can judge the absolute encoder alarm through bus alarm output, IO alarm output, and drive operation panel alarm. At this time, the controller should stop operation immediately, and the absolute motion operation can only be carried out after the alarm is eliminated

2. Alarm output

Absolute encoder alarm can be displayed by the panel Err153, IO output alarm signal, or read alarm information by communication

3. The drive sends an absolute encoder alarm Err153, the main situation is as follows:

(1) When the absolute encoder is used for the first time, absolute encoder alarm will be generated due to the new battery of the motor. At this time, it is necessary to return to the home point and perform multi-turn zero clearing operation

(2) When the battery under voltage is lower than 3.2v, absolute encoder alarm will be generated by the drive.

At this time, the alarm will be automatically eliminated after the battery is recharged by replacing the battery

(3) When the battery voltage is lower than 2.5v, or the battery has a power failure, the absolute encoder alarm will be generated. Even if the battery is replaced, the alarm cannot be eliminated. At this time, the return to the home point and multi-turn zero clearing operation should be performed

4. Alarm processing flow chart

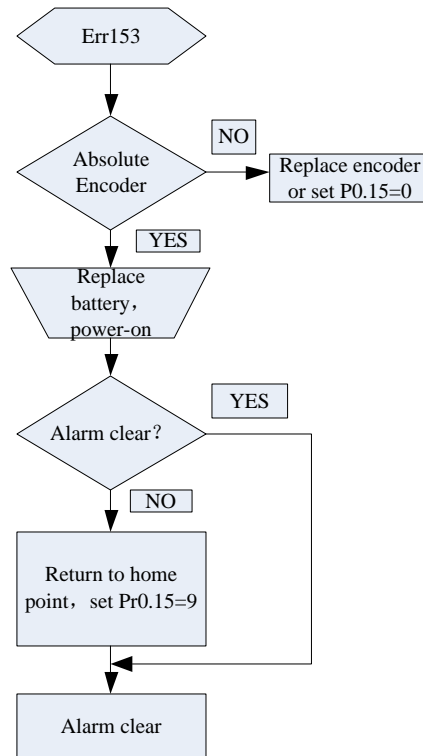

8.11 Other Functions

8.11.1 Zero Speed Output (ZSP)

This function can be configured by IO output function parameters, as described in IO Pr4.10 parameters. When the enabling and time meet the setting conditions, the corresponding output IO port set can output ON

8.11.2 Position Deviation Cleared (CL)

This function can be configured by IO input function parameters, as described in IO Pr4.00 parameters.

Pr4.34	Name	Zero-speed	Mode	P	V	T
	Range	10~20000	Unit	r/min		
	Data length	16bit	Access	R/W		

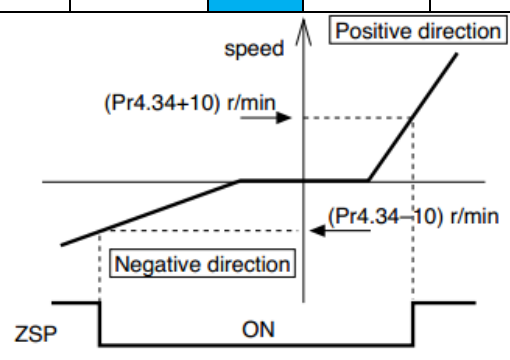
Effective	Immediate		P		
<p>You can set up the timing to feed out the Zero-speed detection output signal (ZSP or TCL) in rotate speed (r/min).</p> <p>The zero-speed detection signal(ZSP) will be fed out when the motor speed falls below the setup of this parameter, Pr4.34</p> <ul style="list-style-type: none"> ● The setup of pr4.34 is valid for both positive and negative direction regardless of the motor rotating direction. ● There is hysteresis of 10[r/min] 					
					

Pr5.17	Name	Counter clear input mode			Mode	P		
	Range	0~4	Unit	—	Default	3		
	Data length	16bit	Access	R/W	Address	0x 0523		
	Effective	Immediate						
Set up the clearing conditions of the counter clear input signal								
Setup Value		Clear Condition						
0/2/4		Invalid						
1		Always clear						
3		Only clear one time						

8.11.3 Position Setup Unit Select

Pr5.20	Name	Position setup unit select			Mode	P		
	Range	0~2	Unit	—	Default	2		
	Data length	16bit	Access	R/W	Address	0x 0529		
	Effective	Immediate						
Specify the unit to determine the range of positioning complete and excessive positional deviation								
Setup Value		Unit						
0		Encoder unit						
1		Command unit						
2		10000pulse/rotation						

Chapter 9 PR-Mode

9.4 Overview of PR-Mode

PR is uniaxial motion control function which is controlled by procedure software. Mainly uniaxial motion command control, save the motion control function of the controller.

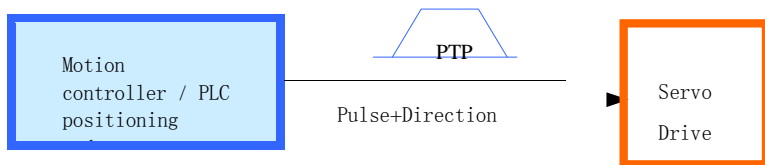

General positioning motion control system

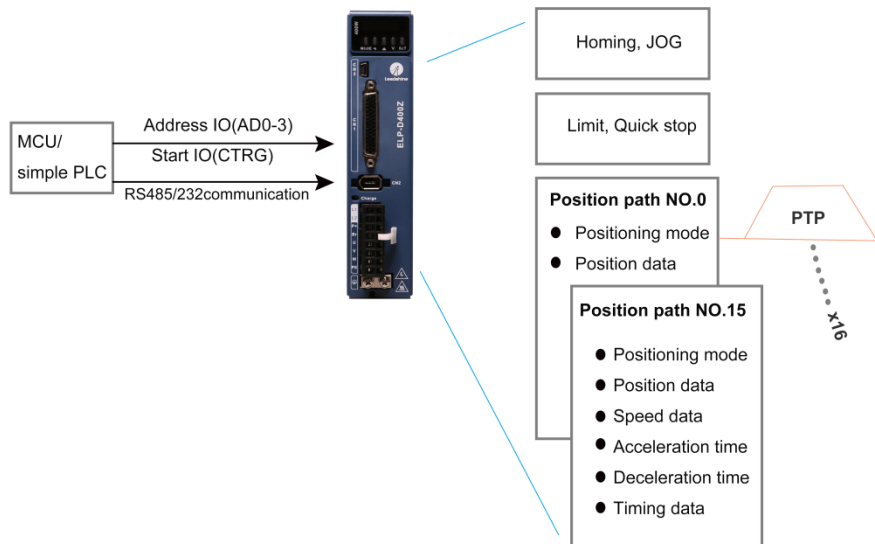

PR-Mode motion control system

9.4.1 Main Function

Main function as below:

PR function	Specification
Homing	Set the homing position by homing process. <ol style="list-style-type: none"> Homing method selectable. Limit switch homing, home switch homing, and manual homing all selectable, Homing direction settable Home deviation position settable. <p>Can be positioned to the specified position after homing.</p> Homing acceleration and deceleration settable <p>Remark: Cannot input external pulse during homing process!</p>

JOG	Trigger positive/negative movement by digital input, for debugging. 1. Positive move, Negative move 2. JOG speed and acceleration selectable
Position limit	Protect machine by position limit. 1. Positive and negative limit switch. 2. Software position limit setting. 3. Position limit deceleration settable. Remark: Software position limit effective after homing process finished.
E-stop	Digital input E-stop signal, stop positioning movement.
Execute movement by digital input	Select 16 motion path by digital input(ADD0~ADD3 allocation to digital input) Execute select motion path by digital input (CTRG allocation to digital input) 1. Motion path can be set as position mode, speed mode and homing mode. 2. Digital input rising edge / double edge.. 3. Support continuous positioning 4. Up to 16 motion path 5. Position, speed, acceleration/deceleration are settable. 6. Pause time settable Remark: Double edge trigger only effective for CTRG !
Execute movement by RS485	Execute movement by RS485 communication.

Remark: (1) For PR-mode, position command adopt unit: 10000pulse/rotation.

(2) PR position control mode, Pr0.01=6.

9.4.2 Programmable Digital Inputs and Outputs in PR-Mode

IO terminal wiring and parameter configuration: Newly added IO of PR on the base of standard IO

Related parameters:

Parameters	Name	Specification
Pr4.00-Pr4.08	SI input selection	Specific of the 9 input terminals' function distribution, refer to functional allocation table.
Pr4.10-Pr4.15	SO output selection	Specific of the 6 output terminals' function distribution, refer to functional allocation table.

IO terminal functional allocation table:

Input			Output		
Signal name	Symbol	set value	signal	Symbol	set value

		Normally open	Normally closed	name		Normally open	Normally closed
Trigger command	CTRG	20h	A0h	Accomplish commands	CMD_OK	20h	A0h
Homing signal	HOME	21h	A1h	Accomplish path	MC_OK	21h	A1h
Forced to stop	STP	22h	A2h	Homing	HOME_OK	22h	A2h
PositiveJOG	JOG+	23h	A3h	Torque limit	TQL	06h	86h
NegativeJOG	JOG-	24h	A4h				
Forward limit	PL	25h	A5h				
Reverse limit	NL	26h	A6h				
Home signal	ORG	27h	A7h				
Path address 0	ADD0	28h	A8h				
Path address 1	ADD1	29h	A9h				
Path address 2	ADD2	2ah	Aah				
Path address 3	ADD3	2bh	Abh				
Torque switch	TC-SEL	09h	89h				

Remark: CMD_OK means PR instruction is sent, maybe motor is not yet in place.

MC_OK means PR instruction is sent and motor is in place.

CTRG, HOME is edge triggering, but effective level need to last more than 1ms.

9.5 PR-Mode Parameters

PR-Mode parameters contain 8th and 9th parameters, 8th parameters are e-stop and control parameter, 9th parameters is store path table.

9.5.1 8th Parameters Specification

Parameters	Name	Definition	Register address
Pr8.00	PR control setting	PR-Mode control function Bit0: 0: CTRG rising edge trigger 1: CTRG double edge trigger Bit1: 0: software limit invalid 1: software limitvalid Bit2: 0: not execute homing after power on	0x6000

		<p>1: execute homing after power on</p> <p>Bit3: 0: Absolute encoder function invalid</p> <p>1: Absolute encoder function valid</p>	
Pr8.01	PR motion path number	Up to 16 paths	0x6001
Pr8.02	Control register	<p>Write 0x1P, P path movement</p> <p>Write 0x20, Homing</p> <p>Write 0x21, set current position as homing position</p> <p>Write 0x40, e-stop</p> <p>Read 0x00P, positioning finished, can receive new data</p> <p>Read 0x10P, In operation</p> <p>Read 0x20P, In positioning</p>	0x6002
Pr8.06	Positive software limit H		0x6006
Pr8.07	Positive software limit L		0x6007
Pr8.08	Negative software limit H		0x6008
Pr8.09	Negative software limit L		0x6009
Pr8.10	Homing method	<p>Homing method</p> <p>Bit0: homing direction</p> <p>=0: Negative direction</p> <p>=1: Positive direction.</p> <p>Bit1: Whether go to the set position after homing</p> <p>=0: no</p> <p>=1: yes.</p> <p>Bit2-7: Homing mode</p> <p>0: homing with limit switch detect</p> <p>1: homing with homing switch detect</p> <p>2: homing with single turn Z signal detect</p> <p>3: homing with torque detect</p> <p>8: set current position as homing position</p> <p>Bit8:</p> <p>0: homing process without Z signal detect</p> <p>1: homing process with Z signal detect</p>	0x600A
Pr8.11	Homing position H		0x600B
Pr8.12	Homing position L		0x600C
Pr8.13	Homing stop positionH		0x600D
Pr8.14	Homing stop position L		0x600E
Pr8.15	Homing high speed		0x600F
Pr8.16	Homing low speed		0x6010
Pr8.17	Homing acceleration		0x6011
Pr8.18	Homing deceleration		0x6012
Pr8.19	Holding time of homing with torque detect		0x6013
Pr8.20	Torque value of homing with torque detect		0x6014
Pr8.21	Overpass distance setting while homing		0x6015

Pr8.22	Deceleration of E-stop while position limit active		0x6016																																																																																					
Pr8.23	Deceleration of E-stop		0x6017																																																																																					
Pr8.26	IO combined trigger mode	0: invalid, CTRG signal trigger 1: valid after homing process finished 2: valid without homing process	0x601A																																																																																					
		When Pr8.26=1 or 2, IO combined triggering takes effect. Trigger the PR path by the combination of ADD0~ADD3.																																																																																						
		<table border="1"> <thead> <tr> <th>ADD3</th> <th>ADD2</th> <th>ADD1</th> <th>ADD0</th> <th>Path</th> </tr> </thead> <tbody> <tr> <td>OFF</td> <td>OFF</td> <td>OFF</td> <td>OFF</td> <td>No action</td> </tr> <tr> <td>OFF</td> <td>OFF</td> <td>OFF</td> <td>ON</td> <td>Path 1</td> </tr> <tr> <td>OFF</td> <td>OFF</td> <td>ON</td> <td>OFF</td> <td>Path 2</td> </tr> <tr> <td>OFF</td> <td>OFF</td> <td>ON</td> <td>ON</td> <td>Path 3</td> </tr> <tr> <td>OFF</td> <td>ON</td> <td>OFF</td> <td>OFF</td> <td>Path 4</td> </tr> <tr> <td>OFF</td> <td>ON</td> <td>OFF</td> <td>ON</td> <td>Path 5</td> </tr> <tr> <td>OFF</td> <td>ON</td> <td>ON</td> <td>OFF</td> <td>Path 6</td> </tr> <tr> <td>OFF</td> <td>ON</td> <td>ON</td> <td>ON</td> <td>Path 7</td> </tr> <tr> <td>ON</td> <td>OFF</td> <td>OFF</td> <td>OFF</td> <td>Path 8</td> </tr> <tr> <td>ON</td> <td>OFF</td> <td>OFF</td> <td>ON</td> <td>Path 9</td> </tr> <tr> <td>ON</td> <td>OFF</td> <td>ON</td> <td>OFF</td> <td>Path 10</td> </tr> <tr> <td>ON</td> <td>OFF</td> <td>ON</td> <td>ON</td> <td>Path 11</td> </tr> <tr> <td>ON</td> <td>ON</td> <td>OFF</td> <td>OFF</td> <td>Path 12</td> </tr> <tr> <td>ON</td> <td>ON</td> <td>OFF</td> <td>ON</td> <td>Path 13</td> </tr> <tr> <td>ON</td> <td>ON</td> <td>ON</td> <td>OFF</td> <td>Path 14</td> </tr> <tr> <td>ON</td> <td>ON</td> <td>ON</td> <td>ON</td> <td>Path 15</td> </tr> </tbody> </table>		ADD3	ADD2	ADD1	ADD0	Path	OFF	OFF	OFF	OFF	No action	OFF	OFF	OFF	ON	Path 1	OFF	OFF	ON	OFF	Path 2	OFF	OFF	ON	ON	Path 3	OFF	ON	OFF	OFF	Path 4	OFF	ON	OFF	ON	Path 5	OFF	ON	ON	OFF	Path 6	OFF	ON	ON	ON	Path 7	ON	OFF	OFF	OFF	Path 8	ON	OFF	OFF	ON	Path 9	ON	OFF	ON	OFF	Path 10	ON	OFF	ON	ON	Path 11	ON	ON	OFF	OFF	Path 12	ON	ON	OFF	ON	Path 13	ON	ON	ON	OFF	Path 14	ON	ON	ON	ON	Path 15
		ADD3		ADD2	ADD1	ADD0	Path																																																																																	
		OFF		OFF	OFF	OFF	No action																																																																																	
		OFF		OFF	OFF	ON	Path 1																																																																																	
		OFF		OFF	ON	OFF	Path 2																																																																																	
		OFF		OFF	ON	ON	Path 3																																																																																	
		OFF		ON	OFF	OFF	Path 4																																																																																	
		OFF		ON	OFF	ON	Path 5																																																																																	
		OFF		ON	ON	OFF	Path 6																																																																																	
		OFF		ON	ON	ON	Path 7																																																																																	
		ON		OFF	OFF	OFF	Path 8																																																																																	
		ON		OFF	OFF	ON	Path 9																																																																																	
		ON		OFF	ON	OFF	Path 10																																																																																	
		ON		OFF	ON	ON	Path 11																																																																																	
ON	ON	OFF	OFF	Path 12																																																																																				
ON	ON	OFF	ON	Path 13																																																																																				
ON	ON	ON	OFF	Path 14																																																																																				
ON	ON	ON	ON	Path 15																																																																																				
Pr8.27	IO combined filtering		0x601B																																																																																					
Pr8.28	Output value of S code		0x601C																																																																																					
Pr8.29	PR alarm	=0x100: Homing overpass limit switch =0x101: Homing process not complete and stop urgently =0x20x: Path X overpass the limit switch	0x601D																																																																																					
Pr8.39	JOG speed		0x6027																																																																																					
Pr8.40	Acceleration of JOG		0x6028																																																																																					
Pr8.41	Deceleration of JOG		0x6029																																																																																					
Pr8.42	Command position H		0x602A																																																																																					
Pr8.43	Command position L		0x602B																																																																																					
Pr8.44	Motor position H		0x602C																																																																																					
Pr8.45	Motor position L		0x602D																																																																																					

9.5.2 9th Parameters Specification

Parameters	Name	Definition	Register address
Pr9.00	Path0 Mode	The motion mode of Path0 motion	0x6200

		<p>Bit0-3: TYPE:</p> <p>0 No Action</p> <p>1 position mode</p> <p>2 velocity mode</p> <p>3 homing mode</p> <p>4 stop</p> <p>Bit4: INS,</p> <p>0 do not interrupt</p> <p>1 interrupt (All interrupt now)</p> <p>Bit5: OVL,</p> <p>0 do not overlap</p> <p>1 overlap</p> <p>Bit6-7:</p> <p>0 absolute position</p> <p>1 relative to command</p> <p>2 relative to motor</p> <p>Bit8-13:</p> <p>0-15 Jump to the corresponding path</p> <p>Bit14: JUMP:</p> <p>0 do not jump</p> <p>1 jump</p>	
Pr9.01	Path0 position H		0x6201
Pr9.02	Path0 position L		0x6202
Pr9.03	Path0 speed	rpm	0x6203
Pr9.04	Path0 acceleration	ms/1000rpm	0x6204
Pr9.05	Path0 deceleration	ms/1000rpm	0x6205
Pr9.06	Path0 Pause time	The pause of path, delay time parameter etc,	0x6206
Pr9.07	Special Parameters	Path 0 is mapped to Pr8.02 parameters	0x6207

9.6 PR-Mode Motion Control

9.6.1 Homing

Homing method include homing with single turn Z signal detect, homing with limit switch detect, homing with homing switch detect, homing with torque detect, set current position as homing position.

Related parameters:

Parameters	Name	Definition	Register address
Pr8.00	Pr control setting	PR-Mode control function Bit0: 0: CTRG rising edge trigger 1: CTRG double edge trigger Bit1: 0: software limit invalid	0x6000

		1: software limit valid Bit2: 0: not execute homing after power on 1: execute homing after power on Bit3: 0: Absolute encoder function invalid 1: Absolute encoder function valid	
Pr8.01	PR motion path number	Up to 16 paths	0x6001
Pr8.02	Control register	Write 0x1P, P path movement Write 0x20, Homing Write 0x21, set current position as homing position Write 0x40, e-stop Read 0x00P, positioning finished, can receive new data Read 0x10P, In operation Read 0x20P, In positioning	0x6002
Pr8.06	Positive software limit H		0x6006
Pr8.07	Positive software limit L		0x6007
Pr8.08	Negative software limit H		0x6008
Pr8.09	Negative software limit L		0x6009
Pr8.10	Homing method	Homing method Bit0: homing direction =0: Negative direction =1: Positive direction. Bit1: Whether go to the set position after homing =0: no =1: yes. Bit2-7: Homing mode 0: homing with limit switch detect 1: homing with homing switch detect 2: homing with single turn Z signal detect 3: homing with torque detect 8: set current position as homing position Bit8: 0: homing process without Z signal detect 1: homing process with Z signal detect	0x600A
Pr8.11	Homing position H		0x600B
Pr8.12	Homing position L		0x600C
Pr8.13	Homing stop position H		0x600D
Pr8.14	Homing stop position L		0x600E
Pr8.15	Homing high speed		0x600F
Pr8.16	Homing low speed		0x6010
Pr8.17	Homing acceleration		0x6011
Pr8.18	Homing deceleration		0x6012
Pr8.19	Holding time of homing with torque detect		0x6013
Pr8.20	Torque value of homing		0x6014

	with torque detect		
Pr8.21	Overpass distance setting while homing		0x6015

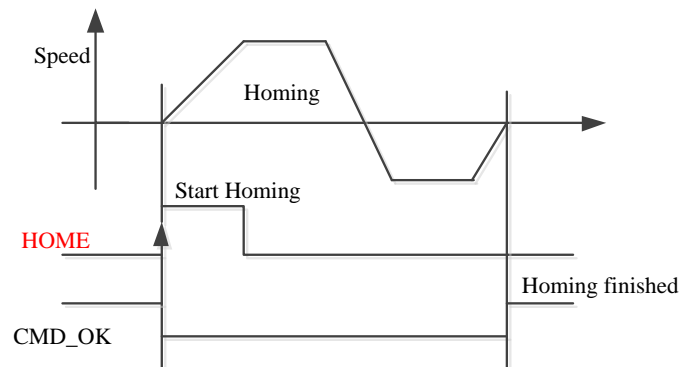

CMD_OK and MC_OK Both of them can be used to represent action is complete, after the signal effective, there will have a delay within 1 ms.

9.6.2 Position Limit and E-Stop

Position limit and E-stop

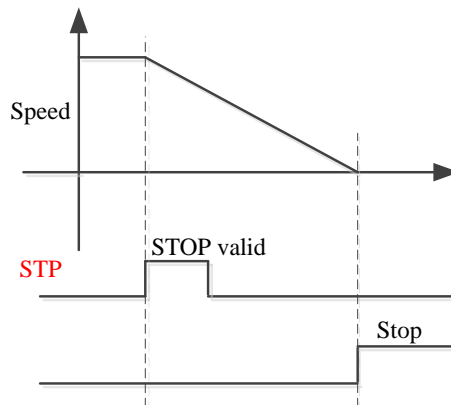

9.6.3 JOG

JOG

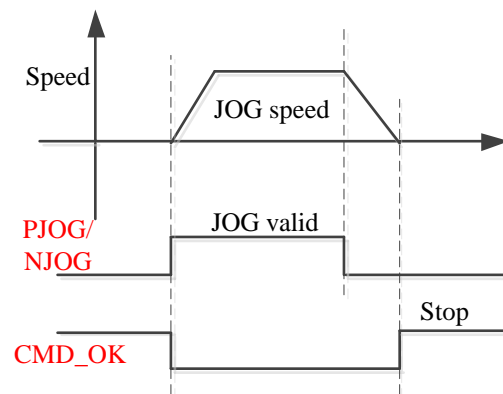

9.6.4 Path Motion

There are three modes of positioning path: Position mode, velocity mode and homing mode.

Related parameters:

Parameters	Name	Definition	Register address
Pr9.00	Path0 Mode	The motion mode of Path0 motion Bit0-3: TYPE: 0 No Action 1 position mode 2 velocity mode 3 homing mode 4 stop Bit4: INS, 0 do not interrupt 1 interrupt (All interrupt now) Bit5: OVL P, 0 do not overlap 1 overlap Bit6-7: 0 absolute position 1 relative to command 2 relative to motor Bit8-13: 0-15 Jump to the corresponding path Bit14: JUMP: 0 do not jump 1 jump	0x6200
Pr9.01	Path0 position H		0x6201
Pr9.02	Path0 position L		0x6202
Pr9.03	Path0 speed	rpm	0x6203

Pr9.04	Path0 acceleration	ms/1000rpm	0x6204
Pr9.05	Path0 deceleration	ms/1000rpm	0x6205
Pr9.06	Path0 Pause time	The pause of path, delay time parameter etc,	0x6206
Pr9.07	Special Parameters	Path 0 is mapped to Pr8.02 parameters	0x6207

9.6.4.1 Single Path Motion

CTRG rising edge /double edge trigger the motion(Pr8.00), take CTRG rising edge signal to trigger path5 as example:

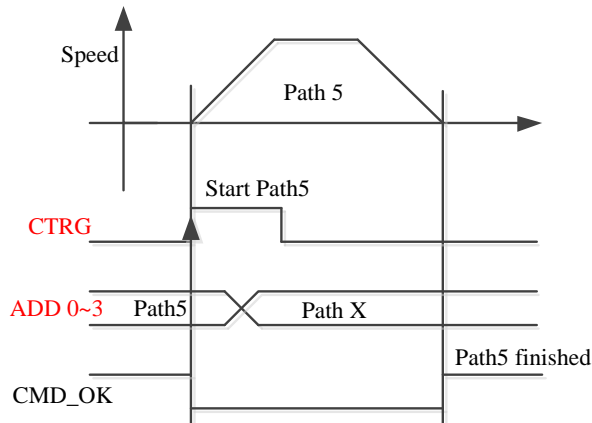

9.6.4.2 Multi Path Interrupt Motion

Interrupt function means a higher path's priority. Interrupt the current valid path, give up the current path and run the new path directly. Similar to the interrupt priority of functions.

Pr9.00 bit4 = 0, interrupt

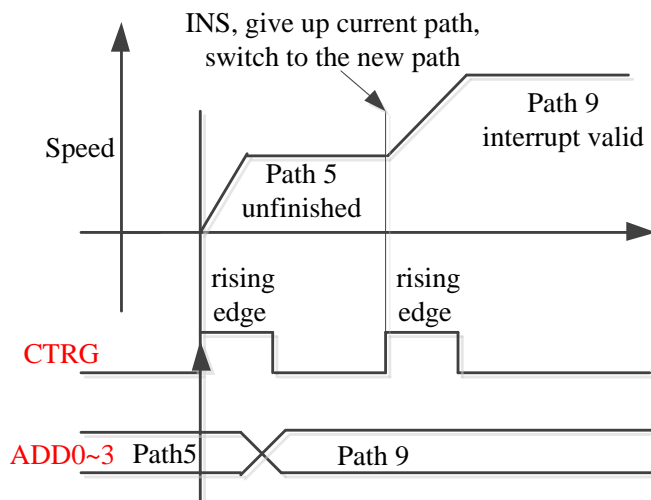

9.6.4.3 Continuous Path Motion without Overlap

After the first path motion finished and pause time delay, start another path motion automatically without trigger signal.

Pr9.00 bit5 = 0, continuous path motion without overlap

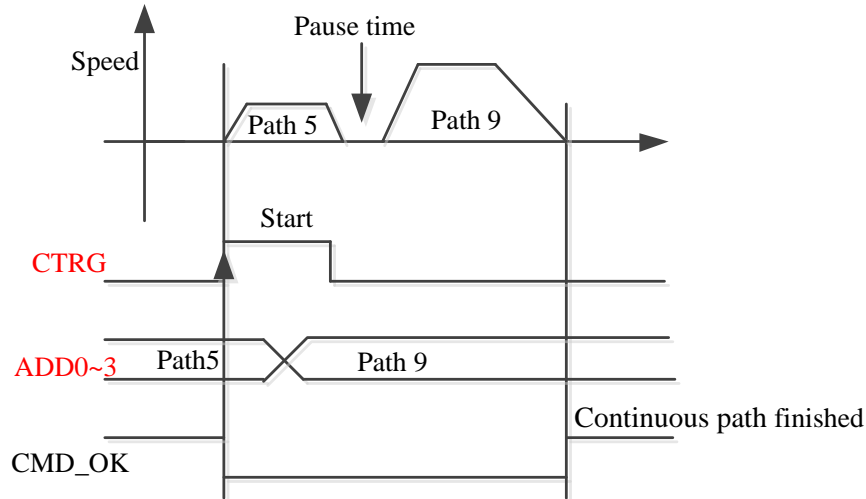

9.6.4.4 Continuous Path Motion with Overlap

During the first path motion in process, start another path motion automatically without trigger signal.

Pr9.00 bit5 = 1, continuous path motion with overlap

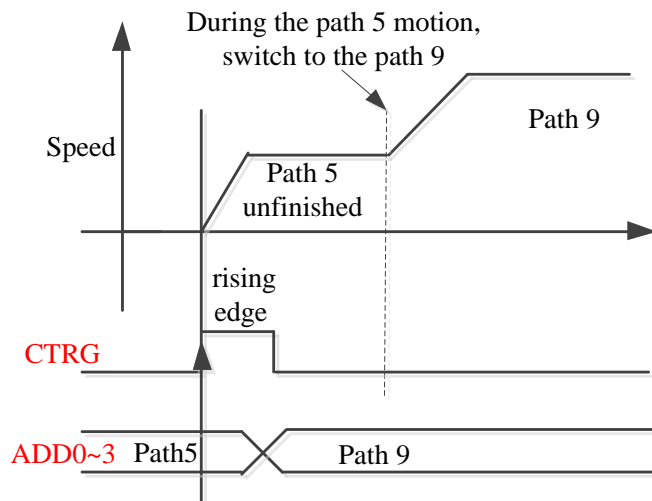

9.7 Execute movement of PR-Mode

9.7.1 Execute Movement by Configuration Software

Configuration software is used for drive parameter setting and save, debugging steps are:

1. Check the wirings.
2. Set the work mode to be PR mode (Pr0.01=6), Internal SERVO-enabled (Pr4.00=83), set the distribution of IO register Pr4.00-Pr4.13) Confirm the running direction and so on.
3. Setting up the PR basic control parameters through upper computer's "PR-Mode" interface. Include: trigger setting, software limit, JOG function, homing function, e-stop function and so on.
4. Setting up the PR positioning path parameters in configuration software " PR-Mode " interface, include:

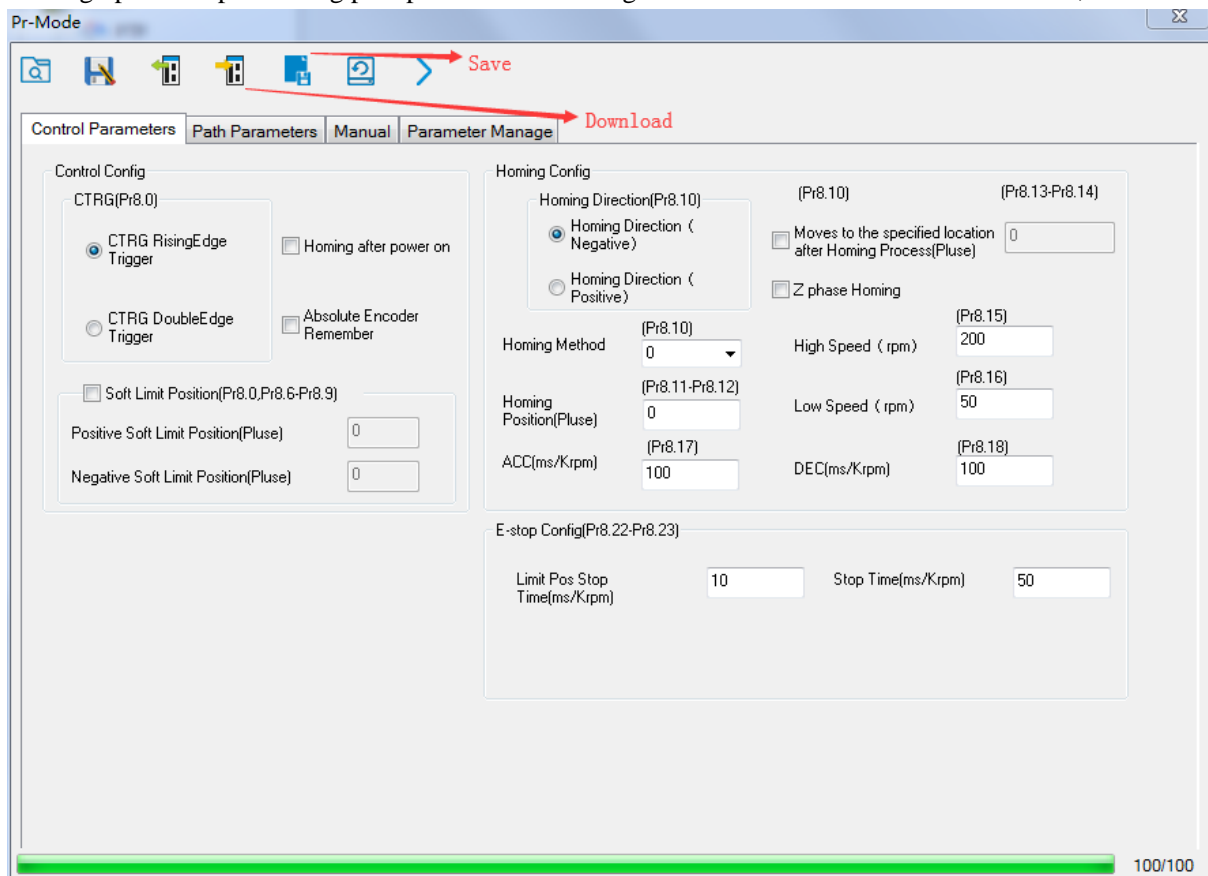

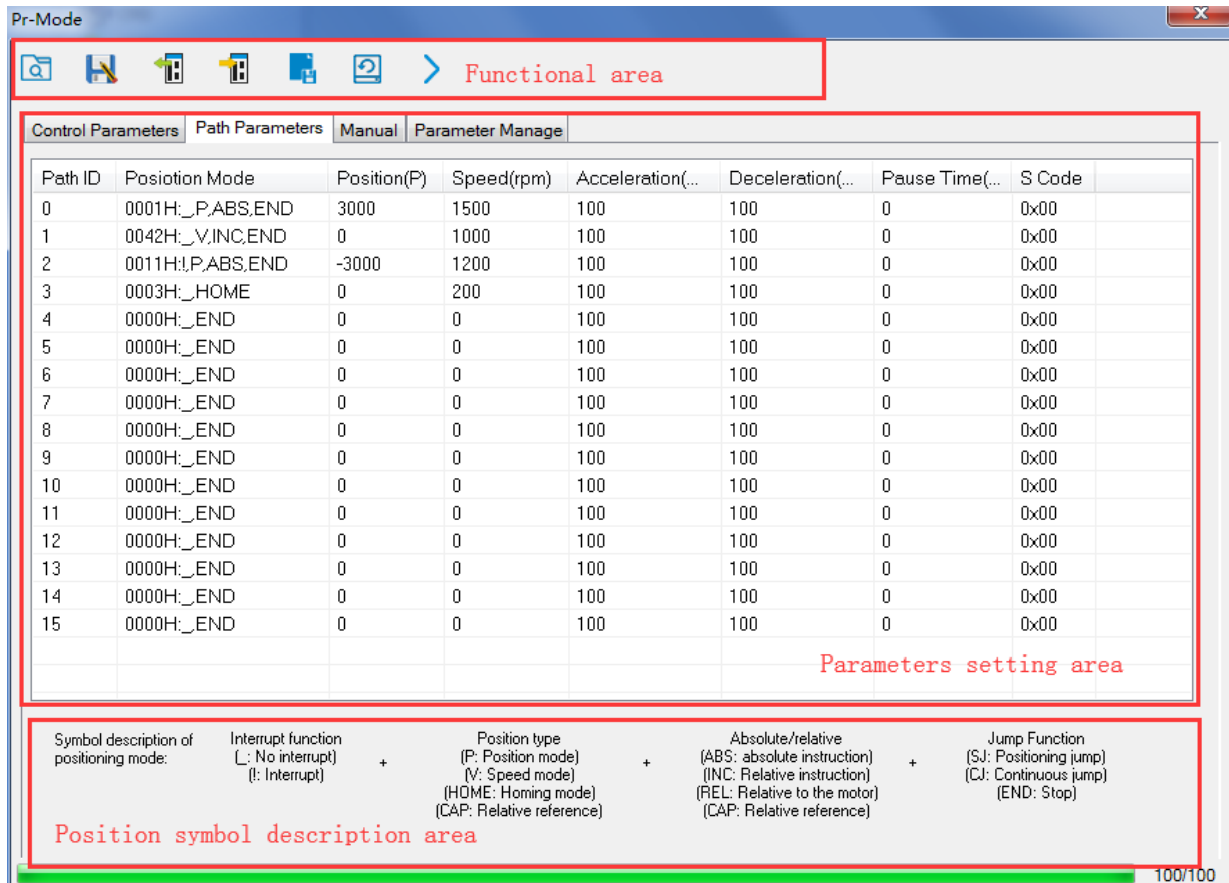

For the convenience of the positioning model expressing, use mnemonic symbol to express, such as:

P , ABS , SJ1 means that path is position addressing, position value is absolute position, jump to No.1 path with delay, and cannot interrupt running.

!V , ABS , SJ1 means that path is speed running, jump to No.1 path with delay, and can interrupt running.

HOME means that path is homing movement.

END means that path is E-stop.

5. Test run

After confirming that the parameters are set correctly, the test begins. The interface is shown below

Click the number marked red in the figure and click start to run according to the speed in the path parameter configuration diagram. Click the corresponding number and click to run at the configured speed. If not, check that the parameters are set correctly

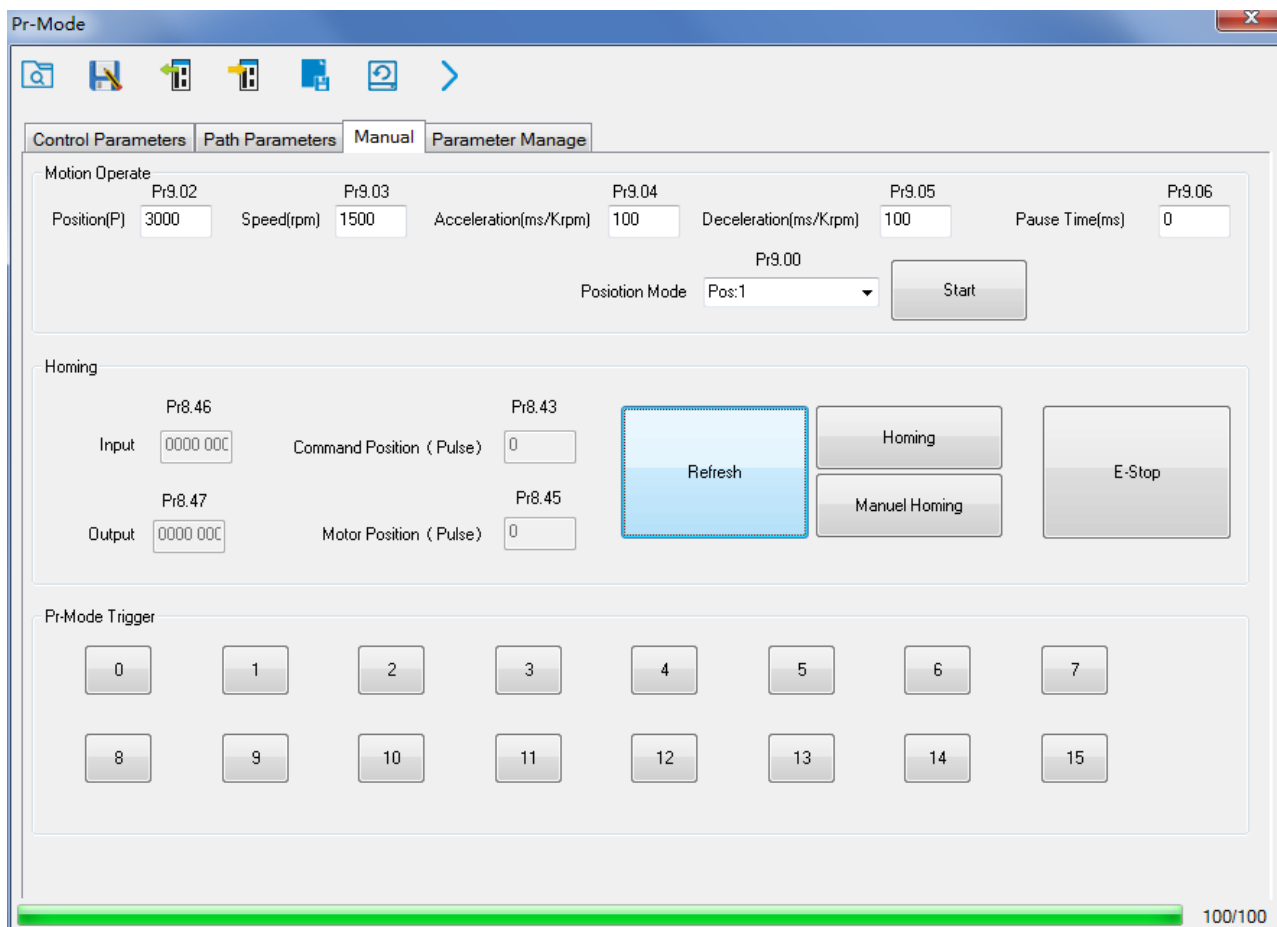

9.7.2 Execute Movement by Digital Signal

PR-Mode motion can be triggered by IO signal.

Parameters	Name	Specification
Pr4.00-Pr4.08	SI input selection	Specific of the 9 input terminals' function distribution, refer to functional allocation table.
Pr4.10-Pr4.15	SO output selection	Specific of the 6 output terminals' function distribution, refer to functional allocation table.

IO terminal functional allocation table:

Input				Output			
Signal name	Symbol	Set value		signal name	Symbol	Set value	
		Normally open	Normally close			Normally open	Normally close
Trigger command	CTRG	20h	A0h	Accomplish commands	CMD_OK	20h	A0h
Homing signal	HOME	21h	A1h	Accomplish path	MC_OK	21h	A1h

Forced to stop	STP	22h	A2h	Accomplish homing	HOME_OK	22h	A2h
PositiveJOG	JOG+	23h	A3h	Torque limit	TQL	06h	86h
NegativeJOG	JOG-	24h	A4h				
Forward limit	PL	25h	A5h				
Reverse limit	NL	26h	A6h				
Home signal	ORG	27h	A7h				
Path address 0	ADD0	28h	A8h				
Path address 1	ADD1	29h	A9h				
Path address 2	ADD2	2ah	Aah				
Path address 3	ADD3	2bh	Abh				
Torque switch	TC-SEL	09h	89h				

IO Trigger

The trigger mode of path motion is divided into edge trigger and IO combination trigger. Determined by control parameter Pr8.26; The edge trigger selects the motion path by the combination of paths, and then triggers the edge event of IO CTRG signal to start a motion. The IO combination trigger means that the combination of IO path select signal is directly used to trigger the motion without IO CTRG signal, the path 0 is invalid. When the IO combination signal turns into a non-zero path, the path will run once triggered after IO filtering. The timing diagram is shown below:

Parameters	Name	Range	Default Value	Definition
Pr8.26	IO combined trigger mode	0~65535	0	0: invalid, CTRG signal trigger 1: valid after homing process finished 2: valid without homing process
Pr8.27	IO combined filtering	0~65535	10	IO combined filtering time

Notes: The path 0 is invalid, so the path 0 cannot be triggered by the IO combined signal, so the IO combined signal will trigger the motion from path 1 to path 15.

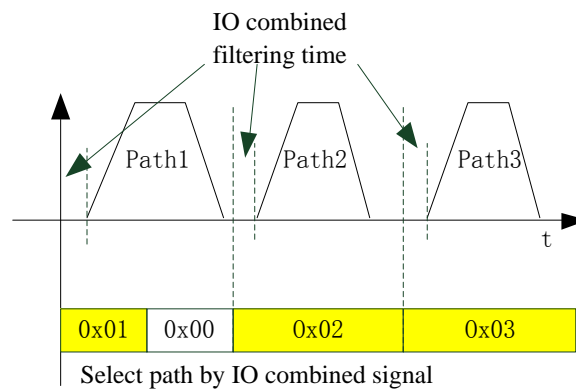

IO combined signal trigger sequence

Notes 1: The path 0 is invalid, so the path 0 cannot be triggered by the IO combined signal. If users want to

trigger incremental position, the IO combined signal should be as follow:

Path X IO combined signal → Path 0 IO combined signal → Path Y IO combined signal, trigger incremental position multiple times by these 3 steps.

Notes 2: If the IO combined trigger mode=2 (Pr8.26=2) , when the drive is powered on , the motion will be triggered while the IO combined signal select path≠0.

9.7.3 Execute Movement by RS485 Communication

Communication control mode can realize same function as IO operation, users can modify parameters and trigger action to run, can control more than one drive by field bus, save the wiring and obtain good flexibility. Communications control includes two modes: Fixed trigger mode and immediately trigger mode.

9.7.3.1 Parameters Setting

Parameters	Name	Specification																												
Pr0.01	Control Mode Setup	Set Pr0.01=6 for PR-Mode																												
Pr4.00	SI1 Input selection	Set 83 for internal Servo-Enable Set 03 for external Servo-Enable (Digital input for Servo-Enable)																												
Pr5.29	Mode setup of RS485 communication	<table border="1"> <thead> <tr> <th>Setup Value</th> <th>Data bit</th> <th>Parity-check</th> <th>Stop bit</th> </tr> </thead> <tbody> <tr> <td>0</td> <td>8</td> <td>Even Parity</td> <td>2</td> </tr> <tr> <td>1</td> <td>8</td> <td>Odd Parity</td> <td>2</td> </tr> <tr> <td>2</td> <td>8</td> <td>Even Parity</td> <td>1</td> </tr> <tr> <td>3</td> <td>8</td> <td>Odd Parity</td> <td>1</td> </tr> <tr> <td>4</td> <td>8</td> <td>None</td> <td>1</td> </tr> <tr> <td>5</td> <td>8</td> <td>None</td> <td>2</td> </tr> </tbody> </table>	Setup Value	Data bit	Parity-check	Stop bit	0	8	Even Parity	2	1	8	Odd Parity	2	2	8	Even Parity	1	3	8	Odd Parity	1	4	8	None	1	5	8	None	2
Setup Value	Data bit	Parity-check	Stop bit																											
0	8	Even Parity	2																											
1	8	Odd Parity	2																											
2	8	Even Parity	1																											
3	8	Odd Parity	1																											
4	8	None	1																											
5	8	None	2																											
Pr5.30	Baud rate setup of RS485 communication	<table border="1"> <thead> <tr> <th>Setup value</th> <th>Baud rate</th> <th>Setup value</th> <th>Baud rate</th> </tr> </thead> <tbody> <tr> <td>0</td> <td>2400bps</td> <td>4</td> <td>38400bps</td> </tr> <tr> <td>1</td> <td>4800bps</td> <td>5</td> <td>57600bps</td> </tr> <tr> <td>2</td> <td>9600bps</td> <td>6</td> <td>115200bps</td> </tr> <tr> <td>3</td> <td>19200bps</td> <td></td> <td></td> </tr> </tbody> </table>	Setup value	Baud rate	Setup value	Baud rate	0	2400bps	4	38400bps	1	4800bps	5	57600bps	2	9600bps	6	115200bps	3	19200bps										
Setup value	Baud rate	Setup value	Baud rate																											
0	2400bps	4	38400bps																											
1	4800bps	5	57600bps																											
2	9600bps	6	115200bps																											
3	19200bps																													
Pr5.31	RS485 slave axis ID	Modbus sub-station address number(Slave ID)																												

Pr8.02	PR trigger	(16bit, 485 address..0x6002) Write 0x1P, P path movement Write 0x20, Homing Write 0x21, set current position as homing position Write 0x40, e-stop Read 0x00P, positioning finished, can receive new data Read 0x10P, In operation Read 0x20P, In positioning
--------	------------	--

9.7.3.2 PR-Mode Parameters Communication Address

8th parameters: $0x6000 + (\text{Parameters NO} - 800)$

The address of Pr8.06: $0x6000 + (806 - 800) = 0x6006$

9th parameters: $0x6200 + (\text{Parameters NO} - 900)$

The address of Pr9.06: $0x6200 + (906 - 900) = 0x6206$

PR-Mode parameters address

RS485 address	Parameter	Name	Specification
0x6000	Pr8.00	PR control setting	HEX
0x6002	Pr8.02	Control register	HEX
0x6006	Pr8.06	Positive software limit H	Pulse
0x6007	Pr8.07	Positive software limit L	Pulse
0x6008	Pr8.08	Negative software limit H	Pulse
0x6009	Pr8.09	Negative software limit L	Pulse
0x600a	Pr8.10	Homing method	HEX
0x600c	Pr8.12	Homing position H	Pulse
0x600d	Pr8.13	Homing stop positionH	Pulse
0x600e	Pr8.14	Homing stop position L	Pulse
0x600f	Pr8.15	Homing high speed	r/min
0x6010	Pr8.16	Homing low speed	r/min
0x6011	Pr8.17	Homing acceleration	ms/Krpm
0x6012	Pr8.18	Homing deceleration	ms/Krpm
0x6016	Pr8.22	Deceleration of E-stop while	r/min
0x6017	Pr8.23	Deceleration of E-stop	r/min
0x602a	Pr8.42	Command positionH	Read only
0x602b	Pr8.43	Command positionL	Read only
0x602c	Pr8.44	Motor position H	Read only
0x602d	Pr8.45	Motor position L	Read only
0x602e	Pr8.46	Input IO status	Read only
0x602f	Pr8.47	Output IO status	Read only
	Pr9.00~Pr9.07	Path 0 parameters	

0x6200	Pr9.00	Path0 Mode	HEX
0x6201	Pr9.01	Path0 position H	Pulse
0x6202	Pr9.02	Path0 position L	Pulse
0x6203	Pr9.03	Path0 speed	r/min
0x6204	Pr9.04	Path0 acceleration	ms/Krpm
0x6205	Pr9.05	Path0 deceleration	ms/Krpm
0x6206	Pr9.06	Path0 Pause time	ms
0x6207	Pr9.07	Special Parameters	
0x6208~0x620f	Pr9.08~Pr9.15	Path 1 parameters	
The same with Pr9.00~Pr9.07			
0x6210~0x6217	Pr9.16~Pr9.23	Path 2 parameters	
The same with Pr9.00~Pr9.07			
0x6218~0x621f	Pr9.24~Pr9.31	Path 3 parameters	
The same with Pr9.00~Pr9.07			
0x6220~0x6227	Pr9.32~Pr9.39	Path 4 parameters	
The same with Pr9.00~Pr9.07			
0x6228~0x622f	Pr9.40~Pr9.47	Path 5 parameters	
The same with Pr9.00~Pr9.07			
0x6230~0x6237	Pr9.48~Pr9.55	Path 6 parameters	
The same with Pr9.00~Pr9.07			
0x6238~0x623f	Pr9.56~Pr9.63	Path 7 parameters	
The same with Pr9.00~Pr9.07			
0x6240~0x6247	Pr9.64~Pr9.71	Path 8 parameters	
The same with Pr9.00~Pr9.07			
0x6248~0x624f	Pr9.72~Pr9.79	Path 9 parameters	
The same with Pr9.00~Pr9.07			
0x6250~0x6257	Pr9.80~Pr9.87	Path 10 parameters	
The same with Pr9.00~Pr9.07			
0x6258~0x625f	Pr9.88~Pr9.95	Path 11 parameters	
The same with Pr9.00~Pr9.07			
0x6260~0x6267	Pr9.96~Pr9.103	Path 12 parameters	
The same with Pr9.00~Pr9.07			
0x6268~0x626f	Pr9.104~Pr9.111	Path 13 parameters	
The same with Pr9.00~Pr9.07			
0x6270~0x6277	Pr9.112~Pr9.119	Path 14 parameters	
The same with Pr9.00~Pr9.07			
0x6278~0x627f	Pr9.120~Pr9.127	Path 15 parameters	
The same with Pr9.00~Pr9.07			

9.7.4 Fixed Trigger Method

Fixed trigger mode: Setup motion parameters. Then, replace CTRG and HOME signal with Pr8.02 (trigger register) to trigger the path. This mode applies to fixed motion and simple operation system.

As below procedure:

1. Firstly, setup homing and path 0~ path 15 which need to run, can transmit parameter configuration temporarily after power on, also can configured to save with upper computer.

2. Enable drive.

3. Implement choice and start of actions by write corresponding instructions into 0x6002 (Pr8.02) .

Write 0x01P, P path motion (write 0x011 to run path 1, write 0x013 to run path 3)

Write 0x020, homing

Write 0x021, set current position as homing position.

Write 0x040, E-stop.

Read 0x000p, means positioning accomplished, can receive new data

Read 0x01P, 0x020, 0x040 means still does not response to instructions.

Read 0x10P, means path is running.

Read 0x200, means instruction accomplished and wait for positioning.

Set path 0 parameters as the table showing, path 1~path15 parameters are the same as path 0

Parameters	Name	Definition	Register address
Pr9.00	Path0 Mode	The motion mode of Path0 motion Bit0-3: TYPE: 0 No Action 1 position mode 2 velocity mode 3 homing mode 4 stop Bit4: INS, 0 do not interrupt 1 interrupt (All interrupt now) Bit5: OVL P, 0 do not overlap 1 overlap Bit6-7: 0 absolute position 1 relative to command 2 relative to motor Bit8-13: 0-15 Jump to the corresponding path Bit14: JUMP: 0 do not jump 1 jump	0x6200
Pr9.01	Path0 position H		0x6201
Pr9.02	Path0 position L		0x6202
Pr9.03	Path0 speed	rpm	0x6203

Pr9.04	Path0 acceleration	ms/1000rpm	0x6204
Pr9.05	Path0 deceleration	ms/1000rpm	0x6205
Pr9.06	Path0 Pause time	The pause of path, delay time parameter etc,	0x6206
Pr9.07	Special Parameters	Path 0 is mapped to Pr8.02 parameters	0x6207

Set path 1~ path15 as same as path 0 .

Implement choice and start of actions by write corresponding instructions into 0x6002 (Pr8.02), to select which path to run.

9.7.5 Immediately Trigger Method

Compared with fixed trigger is limited by 16 path, immediately trigger method is more flexible. It is written to the current path at each time, at the same time trigger the operation of this path. Trigger position, speed, homing by a data frame.

This method adopt path0 to implement, path0 has 8 data in total, the last data Pr9.07 mapped to Pr8.02, write 0x10 to Pr8.02 can trigger path0 motion immediately.

As below procedure:

1. Firstly, configure homing and path which need to run, set these parameters by communication or set these parameters and save with upper computer. (homing must be configured)
2. Enable drive.
3. Trigger fixed path by Pr8.02
4. Or write in immediate data into Pr9.00-9.07, set Pr9.07=0x10, implement immediately running path 0.

For example:

Order	Sending orders (Master->Slave)			Return command (Slave->Master)		
1	ID	Sub-station No.	0~31	ID	Sub-station No.	0~31
2	FC	Function code	0x10	FC	Function code	0x10
3	ADDR	Address	0x62	ADDR	Address	0x62
4			0x00			0x00
5	NUM1	Data quantity Word	0x00	NUM	Actually written data quantity	0x00
6			0x08			0x08
7	NUM2	Data quantity Byte	0x10	CRC	check code	L
						H
8-9	Pr9.00	Mode	XXXX			
10-11	Pr9.01	High position	XXXX			
12-13	Pr9.02	Low position	XXXX			
14-15	Pr9.03	Speed	XXXX			
16-17	Pr9.04	Acceleration	XXXX			
18-19	Pr9.05	Deceleration	XXXX			
20-21	Pr9.06	Delay time	XXXX			
22-23	Pr9.07	Trigger control	0x0010			
24	CRC	Check code	L			
25			H			

Please refer to parameter specification for specific data setting.

9.8 Operation Examples

9.8.1 Execute Movement by Digital Signal

PR-Mode motion can be triggered by IO signal.

- Parameters setting as follows:

Parameters	Name	Specification
Pr0.01	Control Mode Setup	Set Pr0.01=6 for PR-Mode
Pr4.00	SI1 Input selection	Set Pr4.00=83 for internal Servo-Enable Set Pr4.00=03 for external Servo-Enable (Digital input for Servo-Enable)
Pr4.00-Pr4.08	SI input selection	Specific of the 9 input terminals' function distribution, refer to functional allocation table.
Pr4.10-Pr4.15	SO output selection	Specific of the 6 output terminals' function distribution, refer to functional allocation table.

- Setup control parameters, such as: Trigger mode, Homing process, E-stop speed etc. The setting window as follow:

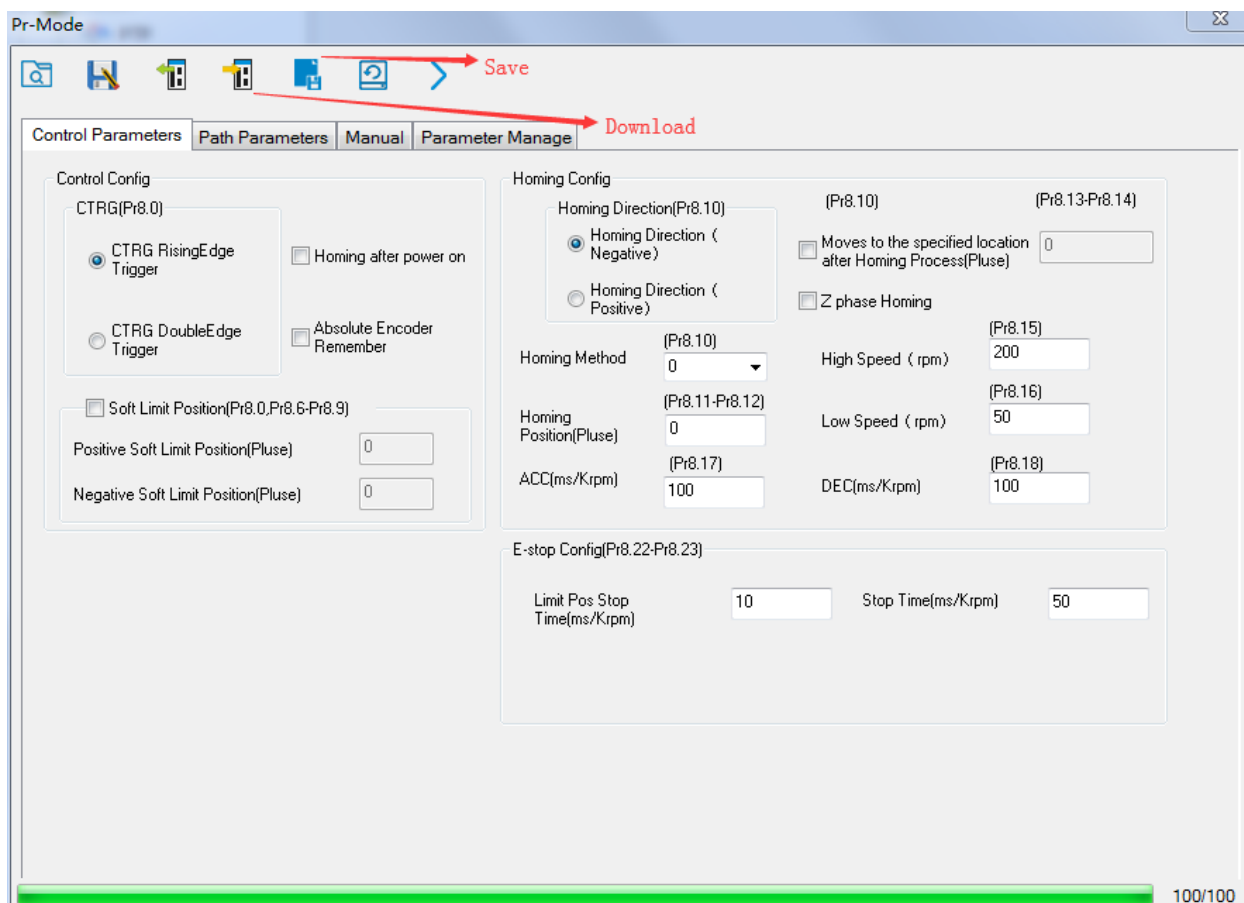

Notes: After the control parameter setting is completed, click the Download button of the toolbar to make the parameters valid. Click Save button to save the parameter to drive permanently.

3. Setup path parameters, such as: Position mode, speed, ACC/DEC, etc.

Functional area: Read file, Upload, Download, Save, etc.

Parameters setting area: Position mode, speed, ACC/DEC, etc.

Position symbol description area: Explains the meaning of the path position symbol.

Notes: After the path parameter setting is completed, click the Download button of the toolbar to make the parameters valid. Click Save button to save the parameter to drive permanently.

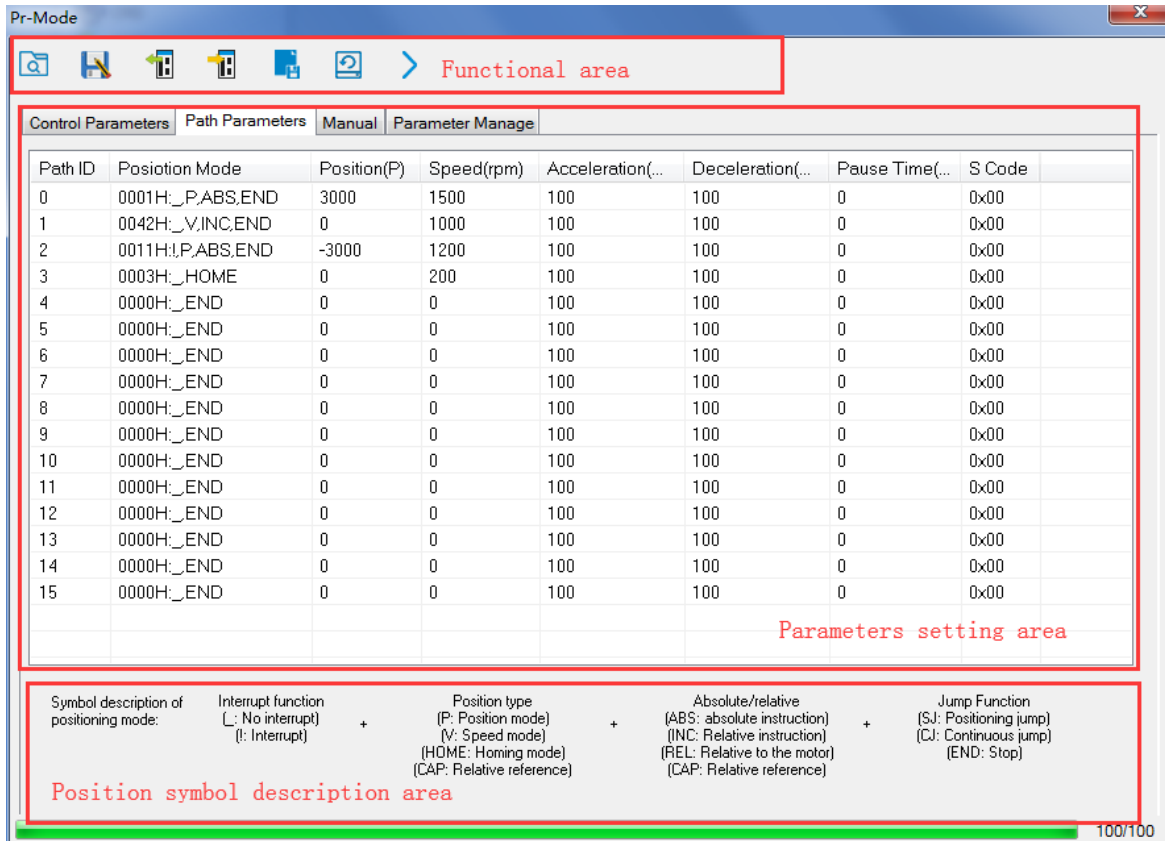

The screenshot shows the 'Pr-Mode' software interface. At the top, there is a toolbar with icons for file operations and a 'Functional area' label. Below the toolbar is a tabbed interface with 'Control Parameters', 'Path Parameters', 'Manual', and 'Parameter Manage'. The 'Path Parameters' tab is active, displaying a table of 16 path parameters. Below the table is a 'Parameters setting area' label. At the bottom, there is a 'Position symbol description area' containing a legend for the path symbols.

Path ID	Position Mode	Position(P)	Speed(rpm)	Acceleration(...)	Deceleration(...)	Pause Time(...)	S Code
0	0001H:_P,ABS,END	3000	1500	100	100	0	0x00
1	0042H:_V,INC,END	0	1000	100	100	0	0x00
2	0011H!:P,ABS,END	-3000	1200	100	100	0	0x00
3	0003H:_HOME	0	200	100	100	0	0x00
4	0000H:_END	0	0	100	100	0	0x00
5	0000H:_END	0	0	100	100	0	0x00
6	0000H:_END	0	0	100	100	0	0x00
7	0000H:_END	0	0	100	100	0	0x00
8	0000H:_END	0	0	100	100	0	0x00
9	0000H:_END	0	0	100	100	0	0x00
10	0000H:_END	0	0	100	100	0	0x00
11	0000H:_END	0	0	100	100	0	0x00
12	0000H:_END	0	0	100	100	0	0x00
13	0000H:_END	0	0	100	100	0	0x00
14	0000H:_END	0	0	100	100	0	0x00
15	0000H:_END	0	0	100	100	0	0x00

Position symbol description area

Symbol description of positioning mode: Interrupt function (L: No interrupt) (!: Interrupt) + Position type (P: Position mode) (V: Speed mode) (HOME: Homing mode) (CAP: Relative reference) + Absolute/relative (ABS: absolute instruction) (INC: Relative instruction) (REL: Relative to the motor) (CAP: Relative reference) + Jump Function (SJ: Positioning jump) (CJ: Continuous jump) (END: Stop)

4. Debug homing process, path trigger motion, input and output, etc. Its debugging interface is shown as follow:

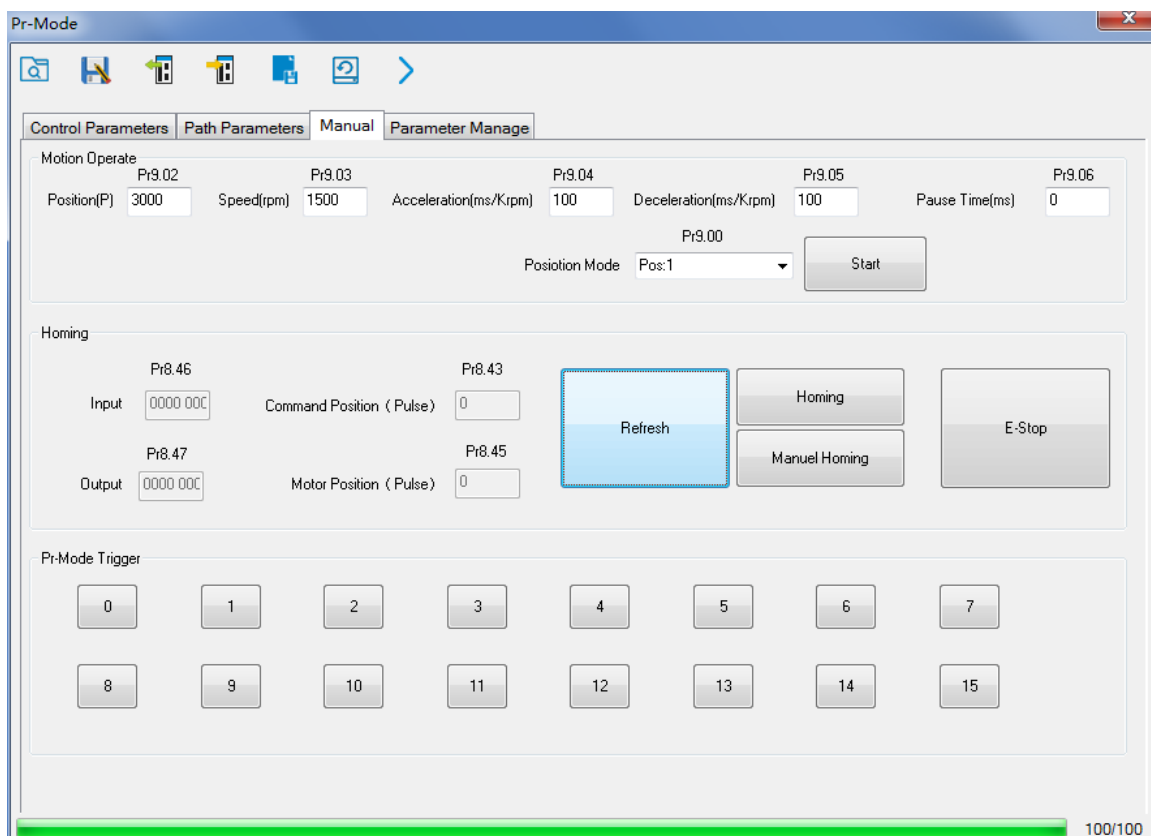

Notes 1: Before using IO CTRG edge signal trigger path motion, select path number by IO combined signal, and then use IO CTRG edge signal to trigger the corresponding path motion

Notes 2: If IO combined trigger mode valid, the IO combined filtering time must be set to ensure that all the IO combined signal changes finished within the filtering time range.

9.8.2 Execute Movement by RS485 Communication

9.8.2.1 Write Single Data 0x06

NO	Send			Receive		
	1	ID	Slave ID	0x01	ID	Slave ID
2	FC	Function code	0x06	FC	Function code	0x06
3	ADDR	Address	H	ADDR	Address	H
4			L			L
5	DATA	Data quantity (Word)	H	DATA	Actually written data quantity	H
6			L			L
7	CRC	Check code	L	CRC	Check code	L
8			H			H

Notes: The number of receive frame is the same as the send frame.

(1) Path 0 (Absolute position mode, 200000pulse, 600rpm, 50ms/1000rpm)

NO	RS485 communication data frame	Details
0	01 06 20 09 00 01 93 C8	Servo enable
1	01 06 62 00 00 01 57 B2	Absolute position mode

2	01 06 62 01 00 03 87 B3	200000pulse, 16 bit H
3	01 06 62 02 0D 40 32 D2	200000pulse, 16 bit L
4	01 06 62 03 02 58 66 E8	600rpm
5	01 06 62 04 00 32 56 66	ACC: 50ms/1000rpm
6	01 06 62 05 00 32 07 A6	DEC: 50ms/1000rpm
7	01 06 60 02 00 10 37 C6	Trigger Path0 motion
8	01 06 60 02 00 40 37 FA	E-stop
9	01 06 20 09 00 00 52 08	Servo disable

(2) Path 0 (Relative position mode, 10000pulse, 600rpm, 50ms/1000rpm)

NO	RS485 communication data frame	Details
0	01 06 20 09 00 01 93 C8	Servo enable
1	01 06 62 00 00 41 56 42	Relative position mode
2	01 06 62 01 00 00 C7 B2	10000pulse, 16 bit H
3	01 06 62 02 27 10 2D 8E	10000pulse, 16 bit L
4	01 06 62 03 02 58 66 E8	600rpm
5	01 06 62 04 00 32 56 66	ACC: 50ms/1000rpm
6	01 06 62 05 00 32 07 A6	DEC: 50ms/1000rpm
7	01 06 60 02 00 10 37 C6	Trigger Path0 motion
8	01 06 60 02 00 40 37 FA	E-stop
9	01 06 20 09 00 00 52 08	Servo disable

(3) Path 0 (Velocity mode, 600rpm, 50ms/1000rpm)

NO	RS485 communication data frame	Details
0	01 06 20 09 00 01 93 C8	Servo enable
1	01 06 62 00 00 02 17 B3	Velocity mode
2	01 06 62 03 02 58 66 E8	600rpm
3	01 06 62 04 00 32 56 66	ACC: 50ms/1000rpm
4	01 06 62 05 00 32 07 A6	DEC: 50ms/1000rpm
5	01 06 60 02 00 10 37 C6	Trigger Path0 motion
6	01 06 60 02 00 40 37 FA	E-stop
7	01 06 20 09 00 00 52 08	Servo disable

(4) Path 1 (Absolute position mode, -200000pulse, 600rpm, 50ms/1000rpm)

NO	RS485 communication data frame	Details
0	01 06 20 09 00 01 93 C8	Servo enable
1	01 06 62 08 00 01 D6 70	Absolute position mode
2	01 06 62 09 FF FC 07 C1	-200000pulse, 16 bit H
3	01 06 62 0A F2 C0 F3 40	-200000pulse, 16 bit L
4	01 06 62 0B 02 58 E7 2A	600rpm
5	01 06 62 0C 00 32 D7 A4	ACC: 50ms/1000rpm
6	01 06 62 0D 00 32 86 64	DEC: 50ms/1000rpm
7	01 06 60 02 00 11 F6 06	Trigger Path1 motion

8	01 06 60 02 00 40 37 FA	E-stop
9	01 06 20 09 00 00 52 08	Servo disable

(5) Path 1 (Velocity mode, 300rpm, 50ms/1000rpm)

NO	RS485 communication data frame	Details
0	01 06 20 09 00 01 93 C8	Servo enable
1	01 06 62 08 00 02 96 71	Velocity mode
2	01 06 62 0B 01 2C E7 FD	300rpm
3	01 06 62 0C 00 32 D7 A4	ACC: 50ms/1000rpm
4	01 06 62 0D 00 32 86 64	DEC: 50ms/1000rpm
5	01 06 60 02 00 11 F6 06	Trigger Path1 motion
6	01 06 60 02 00 40 37 FA	E-stop
7	01 06 20 09 00 00 52 08	Servo disable

(6) Homing

NO	RS485 communication data frame	Details
0	01 06 20 09 00 01 93 C8	Servo enable
1	01 06 60 0A 00 00 B7 C8	Homing Method
2	01 06 60 0F 00 64 A6 22	High speed for homing
3	01 06 60 10 00 1E 16 07	Low speed for homing
4	01 06 60 02 00 20 37 D2	Trigger Homing process
5	01 06 60 02 00 40 37 FA	E-stop
7	01 06 20 09 00 00 52 08	Servo disable

9.8.2.2 Write Multiple Data 0x10

Fixed trigger is limited by 16 segment position, but immediately trigger method is flexible. It is written to the current path at each time, at the same time trigger the operation of this path. Realize position, speed, homing and such actions by a data frame.

This method adopt PR0 to implement, PR0 has 8 data in total, the last data Pr9.07 of it will mapped to Pr8.02, write in 0x10 can trigger Path0 operation immediately, realize data trigger running immediately.

Operating steps:

1. Firstly, configure homing and path which need to run, can power on and send parameter configuration temporarily, also can configure and save with upper computer. (homing must be configured)
2. Enable drive.

NO	RS485 communication data frame	Details
0	01 06 20 09 00 01 93 C8	Servo enable
1	01 06 20 09 00 00 52 08	Servo disable

3. Operate fixed path by Pr8.02
4. write in immediate data by Pr9.00-9.07, and Pr9.07=0x10, implement immediately running path 0.

Demonstrate with immediately trigger method

An example of 485 communication data frame operation is shown below:

Order	Sending orders (Master->Slave)			Return command (Slave->Master)		
	ID	Sub-station No.	0~31	ID	Sub-station No.	0~31
1	ID	Sub-station No.	0~31	ID	Sub-station No.	0~31

2	FC	Function code	0x10	FC	Function code	0x10
3	ADDR	Address	0x62	ADDR	Address	0x62
4			0x00			0x00
5	NUM1	Data quantity Word	0x00	NUM	Actually written data quantity	0x00
6			0x08			0x08
7	NUM2	Data quantity Byte	0x10	CRC	check code	L
						H
8-9	P9.00	Mode	XXXX			
10-11	P9.01	High position	XXXX			
12-13	P9.02	Low position	XXXX			
14-15	P9.03	Speed	XXXX			
16-17	P9.04	Acceleration	XXXX			
18-19	P9.05	Deceleration	XXXX			
20-21	P9.06	Delay time	XXXX			
22-23	P9.07	Trigger control	0x0010			
24	CRC	Check code	L			
25			H			

- Absolute position mode:** 01 10 62 00 00 08 10 00 01 00 01 86 A0 01 F4 00 64 00 64 00 00 00 10 AA BF
- 01 slave ID 01
 - 10 function code, write multi data
 - 62 00 first address mapped to Pr9.00
 - 00 08 8 consecutive operating addresses from 62 00 to 62 07, mapped to Pr9.00~Pr9.07
 - 10 Hexadecimal data of the number of data, 8 register, each address data is divided into high and low bits, $8*2=16$
 - 00 01 data written down to the first addresses of 6200 mapped to Pr9.00.
Motion Mode, absolute position mode
 - 00 01 86 A0 data written down to the second and third addresses of 6201 mapped to Pr9.01; 6202 mapped to Pr9.02.
Hexadecimal data of position=100000plus. All positions in PR mode are in units of 10000P/r, 00 01 86 A0 represents 10 turns of motor rotation.
 - 01 F4 data written down to the 4th addresses of 6203 mapped to Pr9.03
Hexadecimal data of Speed=500r/min
 - 00 64 data written down to the 5th addresses of 6204 mapped to Pr9.04
Hexadecimal data of acceleration time=100ms
 - 00 64 data written down to the 6th addresses of 6205 mapped to Pr9.05
Hexadecimal data of deceleration time=100ms
 - 00 00 data written down to the 7th addresses of 6206 mapped to Pr9.06
Hexadecimal data of the delay time=0ms
 - 00 10 data written down to the 8th addresses of 6207 mapped to Pr9.07, to trigger the action, immediately trigger method (1P, Immediately trigger path P)
 - AA BF the verification code, do not have to directly input, click the corresponding send area verification button automatically generated

The final analysis is as follows: speed is 500r/min, acceleration and deceleration time is 100ms, and the position of absolute positioning is 10 rotations.

01 10 62 00 00 08 10 00 01 00 00 00 00 01 F4 00 64 00 64 00 00 00 10 A0 4A

The final analysis was performed at a speed of 500r/min, acceleration and deceleration time of 100ms, and the position of absolute positioning 0 rotations.

Relative position mode: 01 10 62 00 00 08 10 00 41 00 01 86 A0 01 F4 00 64 00 64 00 00 00 10 EA 8F

- 01 slave ID 01
- 10 function code, write multi data
- 62 00 first address mapped to Pr9.00
- 00 08 8 consecutive operating addresses from 62 00 to 62 07, mapped to Pr9.00~Pr9.07
- 10 Hexadecimal data of the number of data, 8 register, each address data is divided into high and low bits, $8*2=16$
- 00 41 data written down to the first addresses of 6200 mapped to Pr9.00.
Motion Mode, relative position mode
- 00 01 86 A0 data written down to the second and third addresses of 6201 mapped to Pr9.01; 6202 mapped to Pr9.02.
Hexadecimal data of position=100000plus. All positions in PR mode are in units of 10000P/r, 00 01 86 A0 represents 10 turns of motor rotation.
- 01 F4 data written down to the 4th addresses of 6203 mapped to Pr9.03
Hexadecimal data of Speed=500r/min
- 00 64 data written down to the 5th addresses of 6204 mapped to Pr9.04
Hexadecimal data of acceleration time=100ms
- 00 64 data written down to the 6th addresses of 6205 mapped to Pr9.05
Hexadecimal data of deceleration time=100ms
- 00 00 data written down to the 7th addresses of 6206 mapped to Pr9.06
Hexadecimal data of the delay time=0ms
- 00 10 data written down to the 8th addresses of 6207 mapped to Pr9.07, to trigger the action, immediately trigger method (1P, Immediately trigger path P)
- EA 8F the verification code, do not have to directly input, click the corresponding send area verification button automatically generated

The final analysis is as follows: speed is 500r/min, acceleration and deceleration time is 100ms, and the position of relative positioning is 10 rotations.

Homing mode: 01 06 60 02 00 21 F6 12 (Back to origin high-speed, low-speed, and back to zero mode can be set in the eighth set of parameters, using default values this time)

Caution: In Pr mode, the origin induction switch is connected to the drive, which is different from the impulse control. Limited by conditions, only the current position can be demonstrated to the customer: Write 0x021, The current location manually set to zero.

The frame format function is:

- 01 slave ID 01
- 06 function code, write single data

NO	Send		Receive
----	------	--	---------

1	ID	Slave ID	0~31		ID	Slave ID	0~31
2	FC	Function code	0x06		FC	Function code	0x06
3	ADDR	Address	H		ADDR	Address	H
4			L				L
5	DATA	Data quantity (Word)	H		DATA	Actually written data quantity	H
6			L				L
7	CRC	check code	L		CRC	check code	L
8			H				H

60 02 register address, mapped to Pr8.02

00 21 the data write into the register, Write 0x021, The current location manually set to zero.

Write 0x01P, P section positioning

Write 0x020, homing

Write 0x021, set current position as homing point

Write 0x040, e-stop

F6 12 the verification code, do not have to directly input, click the corresponding send area verification button automatically generated

After the current position is set to zero manually, you can click absolute positioning again to send it manually, indicating that the current position is set to zero manually

JOG is IO input, there is no communication control method, you can push users to write relative positioning data in real time, and trigger inching motion immediately instead.

Velocity mode: 0110 62 00 00 08 10 00 02 00 00 00 00 03 E8 00 64 00 64 00 00 00 10 DA 41

01 slave ID 01

10 function code, write multi data

62 00 first address mapped to Pr9.00

00 08 8 consecutive operating addresses from 62 00 to 62 07, mapped to Pr9.00~Pr9.07

10 Hexadecimal data of the number of data, 8 register, each address data is divided into high and low bits, $8*2=16$

00 02 data written down to the first addresses of 6200 mapped to Pr9.00, speed mode

00 00 00 00 data written down to the second and third addresses of 6201 mapped to Pr9.01; 6202 mapped to Pr9.02.Hexadecimal data of position=0plus. All positions in PR mode are in units of 10000P/r, , 00 00 00 00 represents 0 turns of motor rotation in Speed mode

03 E8 data written down to the fourth addresses of 6203 mapped to Pr9.03
Hexadecimal data of Speed=1000r/min

00 64 data written down to the five addresses of 6204 mapped to Pr9.04
Hexadecimal data of acceleration time=100ms

00 64 data written down to the six addresses of 6205 mapped to Pr9.05
Hexadecimal data of deceleration time=100ms

00 00 data written down to the seven addresses of 6206 mapped to Pr9.06
Hexadecimal data of the delay time=0ms

00 10 data written down to the eight addresses of 6207 mapped to Pr9.07 , to trigger the action,
Immediately trigger method (1P, Immediately trigger path-P, The sample Pr9.00~9.07 is the

positioning related data of path-0)

DA 41 the verification code, do not have to directly input, click the corresponding send area verification button automatically generated

The final analysis is as follows: speed=1000r/min, acceleration and deceleration time is 100ms, velocity mode

E-stop: 01 06 60 02 00 40 37 FA

Servo enable: 01 06 20 09 00 01 93 C8

Servo disable: 01 06 20 09 00 00 52 08

Chapter 10 Order Guidance

10.1 Capacity Selection

To determine the capacity of servo system, we must consider the inertia of load, torque of load, the positioning accuracy, the requirement of the highest speed; consider the selection according to the following steps:

1) Calculate Inertia of Load and Torque

You can refer to relative information to calculate inertia of load, torque of load, acceleration/deceleration torque as the next step basis.

2) Identify Mechanical Gear Ratio

According to the maximum speed and the highest speed of the motor ,you can calculate the maximum of mechanical reduction ratio, by using it and minimum of motor turning unit ,to calculate if they can meet the requirements of the smallest position unit or Not. If the positional precision is high, you can increase the mechanical reduction ratio or select motor with higher capacity.

3) Calculate Inertia and Torque

Convert mechanical reduction ratio of the load inertia and load torque to the motor shaft, while the result shall be Not 5 times more than motor inertia. If the requirements can't be matched, you can increase the mechanical reduction ratio (the actual maximum speed reducing) or select larger capacity motor.

10.2 Electronic Gear Ratio

In position control mode, the actual speed = command pulse velocity \times G \times mechanical reduction ratio.

In position control mode, the actual load minimum displacement = minimum command pulse travel \times G \times mechanical reduction ratio.

【Note】If the electronic gear ratio of G is Not 1, gear ratio division may have the remainder, then there will be position deviation existed, the maximum deviation is the minimum of rotation (minimum resolution).

Appendix Modbus Communication

The Modbus products of ELP series are based on serial communication bus with Modbus-RTU. Since Modbus is a master/slave protocol, that means only one node is a master and the others are slave node. ELP AC servo uses the standard RS-485 physical layer, up to 31 servo drives can be connected to one master station.

A.1 Wiring (CN4&CN5)

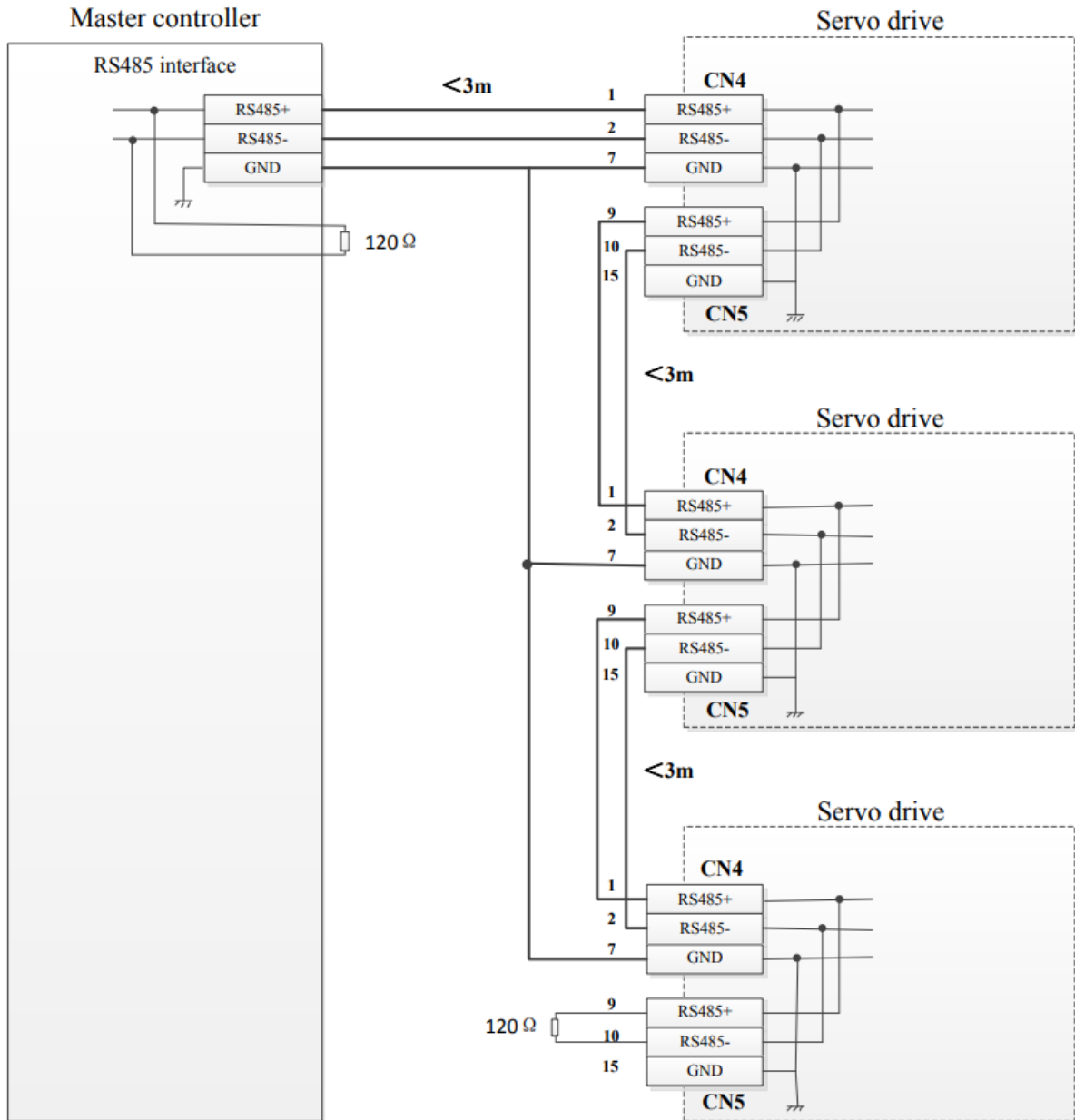
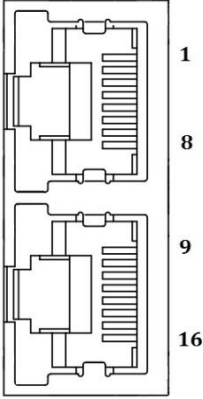

Figure: Multi-drive network connection

Pin layout of connector

Port	RJ45	Pin	Signal
CN4 CN5		1 , 9	RDO+(RS485+)
		2 , 10	RDO-(RS485-)
		3 , 11	
		4 , 12	
		5 , 13	
		6 , 14	
		7 , 15	GND
		8 , 16	/
			PE

Note:

- (1) The shorter the connection between each node is the better. The recommend connection should no more than 3m;
- (2) Connect one terminal resistor to each end of the node. The recommended resistance value is 120 ohms;
- (3) Shielded twisted pair is recommended for RS485 communication wirings;
- (4) Connect GND is essential for communication;
- (5) When using the shield wire, the two ends of the shield should connect PE, not GND, otherwise the port will be damaged;
- (6) In order to reduce interference, RS485 communication cables should installed separately from other cables;

A.2 Communication Parameters Setting

Communication specifications

Protocol	Modbus-RTU
Physical layer	RS485(1:N, Max 31 axis)
Baud rate	2400, 4800, 9600, 19200, 38400, 57600, 115200 bps
Data	8bit
Parity	None, even, odd
Start bit	1bit
Stop bit	1, 2bit

Pr5.29 *	Name	Modbus communication setting			Mode	P	V	T
	Range	0~255	Unit	—	Default	5		
	Data length	16bit	Access	R/W	Address	053BH		
	Effective	Power-on again						

Setup Value	Data bit	Parity-check	Stop bit
0	8	Even Parity	2
1	8	Odd Parity	2
2	8	Even Parity	1
3	8	Odd Parity	1
4	8	None	1
5	8	None	2

Pr5.30 *	Name	Baud rate setup of Modbus communication			Mode	P	V	T
	Range	0~6	Unit	—	Default	2		
	Data length	16bit	Access	R/W	Address	053DH		
	Effective	Power-on again						

Set up the communication baud rate of RS485.

Setup value	Baud rate	Setup value	Baud rate
0	2400bps	4	38400bps
1	4800bps	5	57600bps
2	9600bps	6	115200bps
3	19200bps		

Pr5.31 *	Name	slave axis ID			Mode	P	V	T
	Range	1~31	Unit	—	Default	1		
	Data length	16bit	Access	R/W	Address	053FH		
	Effective	Power-on again						

During communication with the host (e.g. PC) to control multiple drives, the ID being accessed by the host should be unique identified.

Note: when using RS232/RS485, the maximum valid value is 31.

A.3 Modbus Transmission Protocol

A.3.1 Message Types

Communications are configured as the single master and multiple slaves method. The drive operates as a slave.

The messages sent/received between the master and drive are classified into two types below:

- Send: Messages transferred from the master to the drive.
- Receive: Messages transferred from the drive to the master.

A.3.2 Function Codes (FC)

The three types of FC below are supported:

Category	FC	Function
Data manipulation	03h (3)	Read out various register
	06h (6)	Write in single register
	10h (16)	Write in various register

- **FC 03h(Read out various register)**

The function code of read out various register is 0x03. Now take slave ID 1, read 2 register as an example: (H is 8bit high for 16bit, L is 8bit low for 16bit)

NO	Send frame			Receive frame		
	1	ID	Slave ID	0x01	ID	Slave ID
2	FC	Function code	0x03	FC	Function code	0x03
3	ADDR	Address	H	NUM	Data quantity (Byte)	0x00(H)
4			L			0x04(L)
5	NUM	Data quantity (Word)	0x00(H)	DATA1	Data1	H
6			0x02(L)			L
7	CRC	Check code	L	DATA2	Data2	H
8			H			L
9				CRC	Check code	L
10						H

Notes: The number of receive data is twice the number of send data quantity.

$$1\text{word}=2\text{bytes}=16\text{bits}$$

The communication data is shown as below:

[Send frame] 01 03 00 04 00 02 85 CA

[Receive frame] 01 03 04 00 00 00 02 7B F2

Send frame: The sent frame represents that the master reads the data from slave ID 1, the starting address is 0x0004, the length is 2 Word (16bit). The CRC check code is 0xCA85.

Receive frame: The receive frame represents that the receive data is 4 byte (8bit) and the data is 00 00 00 02. The CRC check code is 0xF27B.

- **FC 06h(Write in single register)**

The function code of write in single register is 0x06. Now take slave ID 1, write 1 register as an example: (H is 8bit high for 16bit; L is 8bit low for 16bit)

NO	Send frame			Receive frame		
	1	ID	Slave ID	0x01	ID	Slave ID
2	FC	Function code	0x06	FC	Function code	0x06
3	ADDR	Address	H	ADDR	Address	H
4			L			L
5	DATA	Data quantity (Word)	H	DATA	Actually written data quantity	H
6			L			L

7	CRC	Check code	L	CRC	Check code	L
8			H			H

Notes: The number of receive frame is the same as the send frame.

1word=2bytes=16bits

The communication data is shown as below:

[Send frame] 01 06 00 04 00 02 49 CA

[Receive frame] 01 06 00 04 00 02 49 CA

Send: The send frame represents that the master write the data into slave ID 1, the starting address is 0x0004, the length is 2 Word (16bit). The data is 0x0002. The CRC check code is 0xCA49.

Receive: The receive frame represents that write data into slave ID 1 finished successfully.

● **FC 10h(Write in various register)**

The function code of write various register is 0x10. In this case, 16 bits of multiple register are written.

Now take slave ID 1, write 2 register as an example: (H is 8bit high for 16bit; L is 8bit low for 16bit)

NO	Send frame			Receive frame		
1	ID	Slave ID	0x01	ID	Slave ID	0x01
2	FC	Function code	0x10	FC	Function code	0x10
3	ADDR	Address	H	ADDR	Address	H
4			L			L
5	NUM1	Data quantity (Word)	0x00 (H)	NUM	Actually written data quantity	0x00 (H)
6			0x02 (L)			0x02 (L)
7	NUM2	Data quantity (Byte)	0x04 (2* NUM1)	CRC	Check code	L
8	DATA1	DATA1	H			H
9			L			
10	DATA2	DATA2	H			
11			L			
12	CRC	Check code	L			
13			H			

The communication data is shown as below:

[Send frame] 01 10 00 04 00 02 04 01 00 00 00 F3 A0

[Receive frame] 01 10 00 04 00 02 00 09

Send frame: The send frame represents that the master write the data into slave ID 1, the starting address is 0x0004, the length is 2 Word (16bit). The data is 0x01000 and 0x0000. The CRC check code is 0xA0F3.

Receive frame: The receive frame represents that write data into slave ID 1 finished successfully.

A.3.3 Error Response

The drive return an error response if it has not succeeded the process specified by a sent frame. The message frame is as follows:

NO	Error response frame data (Slave-->Master)		
1	ID	Slave ID	1~31

2	FC	Function code	(0x03/0x06/0x10)+0x80
3	Error code	Error code	0x01/0x02/0x03/0x08
4	CRC	Check code	L
5			H

● **Function code(FC) filed**

Error responses from slaves are returned as one is set on the MSB of the FC specified by the send frame.

Function code (Send frame)	Function code (Error response)
0x01	0x81
0x02	0x82
0x03	0x83
0x08	0x88

The error code and its meaning are as follows:

Error code	Meaning
0x01	Incorrect FC (An incorrect FC is specified.)
0x02	Incorrect address (An incorrect address is specified)
0x03	Incorrect data (An abnormal value is specified in the information field.) such as write data exceeding the limit
0x08	CRC check error

The communication data is shown as below:

[Send] 01 11 00 04 00 02 04 01 00 00 00 F3 A0

[Receive] 01 91 08 4C 56

Receive: CRC check error in the send data frame sent by the master station

[Send] 01 11 00 04 00 02 04 01 00 00 00 A2 65

[Receive] 01 91 01 8C 50

Receive: Function code error in the send data frame sent by the master station

A.4 Communication Problems and Solutions

A.4.1 Troubleshoot Steps

1. Whether the communication parameters are set correctly (Slave ID No. repetition, baud rate is set the same, data format is consistent).
2. Whether the terminal resistance connection is correct?
3. Whether the wiring is standard for anti-interference?
4. PE connection between ground and ground wire.
5. Whether the communication lines are installed separately from other wirings.

A.4.2 Frequently Asked Questions

1. Terminal resistance

The correct connection of terminal resistance is shown in the above figure, terminal resistors need to be connected to the first and last section of the bus, recommended 120 Ohm resistor.

You can measure the resistance value at both ends of the RS485 with a multimeter, the normal value is approximately equal to 60 ohms. If it is much less than 60 ohms, the terminal resistance value is probably wrong. If it is equal to 0 ohms, the bus is short-circuited. If it is much greater than 60 ohms, it is possible that some node bus ports are damaged.

2. Wiring error

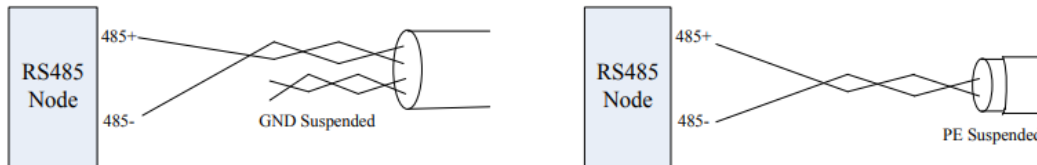

Firstly, confirm that the signal line of RS485 is connected correctly. Secondly, confirm whether the communication reference ground is connected correctly. If the node has no communication reference ground, it will be suspended, as shown in figure above. The shielding PE is connected the same way.

3. Signal interference

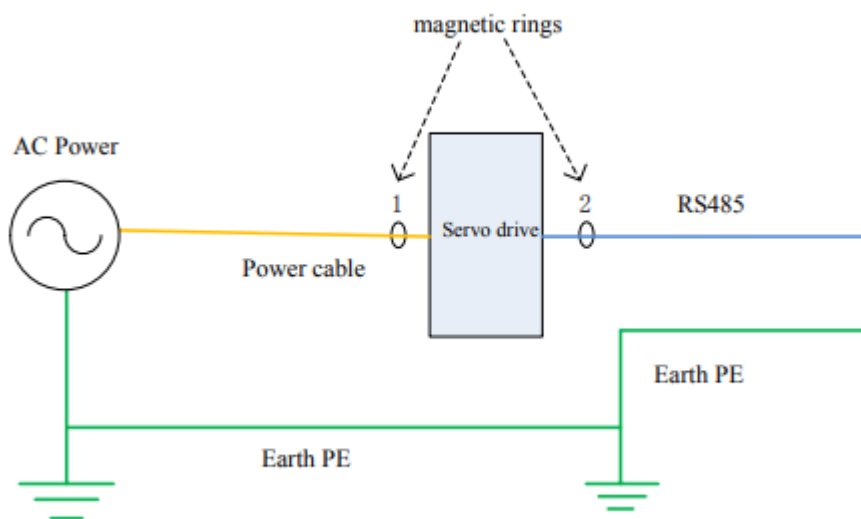

When there is an external interference signal in communication, magnetic rings can be placed at 1 and 2 in above figure to suppress the incoming external interference signal into the bus.

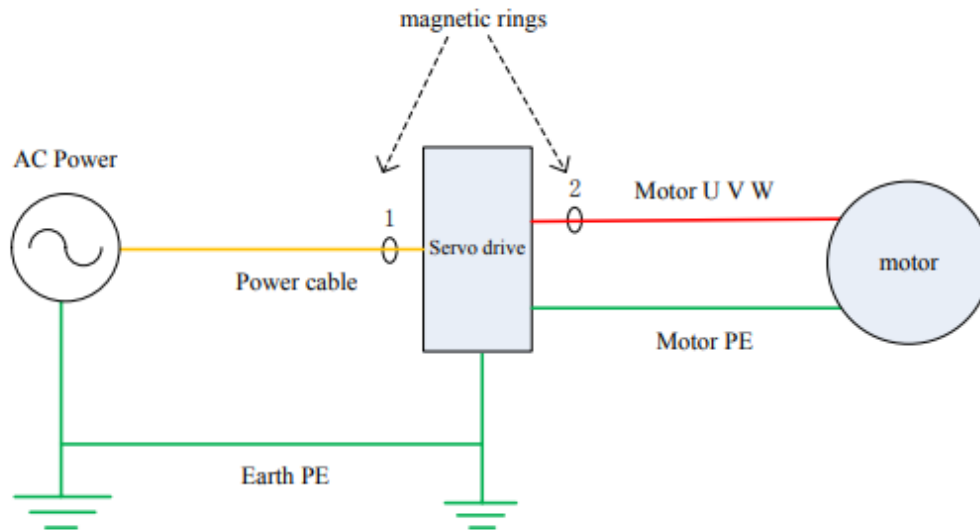

When there is an internal interference signal in communication, magnetic rings can be placed at 1 and 2 in above figure to suppress the incoming internal interference signal into the bus. Loop the UVW line around the magnetic ring three times. Be careful not to connect PE to the magnetic ring.

Contact Us

China Headquarters

Address: 15-20/F, Block B, Nanshan I Valley, No.3185, Shahe West Road, Nanshan District, Shenzhen, Guangdong, 518055, China

Technical Support

Tel: 86-755-2641-8774 (for Asia, Australia, Africa areas)

86-755-2665-5136 (for America areas)

86-755-8654-2465 (for Europe areas)

Email: tech@leadshine.com

Sales Hot Line

Tel: 86-755-2641-7674 (for Asia, Australia, Africa areas)

86-755-2640-9254 (for Europe areas)

86-755-2641-7617 (for America areas)

Email: sales@leadshine.com