

Company Profile

Founded in 1997 by Warren Li, a MIT PhD graduate and former USA professor, Leadshine Technology Co., Ltd. is a leading technology company dedicated to design, manufacture, market, and support reliable and affordable motion control products based on the latest control technologies. Leadshine offers a full complement of products including motion controllers, control systems, integrated servos, servo drives & motors, easy servo drives & motors (closed loop steppers), integrated easy servo motors, integrated steppers, stepper drives & motors. Today, Leadshine is one of the largest motion control companies in the world to provide solutions and quality products to tens of industries, and thousands of OEM clients in Asia, Europe, North & South America, Australia, and Africa.

R&D

Led by Dr. Li, a PhD majored in robotics & servo controls from MIT, Leadshine has one of the strongest R&D teams in the motion control industry. The team consists of more than 100 R&D engineers and all of them are highly educated with most of them carry PhD & Master degrees in controls, electrical & electronics engineering, mechanical engineering, mechatronics, computer engineering, and computer science. Their strong background and experience allow Leadshine capable of designing superior quality products based the latest technology in the most efficient way.

Product Quality

Leadshine operates manufacturing facilities which are superiorly equipped, professionally staffed, and ISO-9001 certified. That allows Leadshine to provide highly reliable quality motion control products OEM clients in the shortest time.

Leadshine's products have proven records of being successfully adopted in thousands of applications such as CNC routers, mills, plasmas, lathes, laser cutters/engravers/markers, inkjet printers, plotters, electronics equipments, medical equipments, semiconductor assembly & inspection machines, electronics machines, packaging equipments, textile machines, robotics, pick-and-place devices, etc. In most cases, Leadshine's standard "off-the-shelf" products are able to satisfy the motion control needs for most applications. For many OEM applications with special requirements, Leadshine also offers customized products with optimized performance.

Support and Service

Leadshine believes the key to be a successful motion product supplier is the commitment to fully understanding our customer's applications and working closely with our OEM clients. In many cases, Leadshine engineers can participate in the whole process of client product development, including initial application evaluation, product selection, design help & suggestion. Our expertise and experience allow us to help OEM clients to produce competitive high quality machines in their industries.



Pulse Control Stepper Drives



- EM-S---Enhanced Version
- DM-E---Cost-effective Version

EM-S Series---Enhanced Performance

As chips and software are constantly updated and optimized, Leadshine made the new EM-S series stepper drives based on 20 years accumulation of application and production experiences. They not only retain DM series' features such as reliability, low noise, low heat, and low vibration, but also add ten new features such as alarm, brake, smoothing time, etc. They can drive step motors with NEMA 8/11/14/17/23/24/34.

Features

- ▶ Torque increased by 10%-25%
- ▶ Step & DIR or CW & CCW control
- ▶ Alarm and Brake outputs
- ▶ 200KHz (500KHz optional) max frequency
- ▶ 5V or 24V signal voltage optional
- ▶ Soft-start with no "jump"
- ▶ Over-voltage, over-current and motor cable error protections

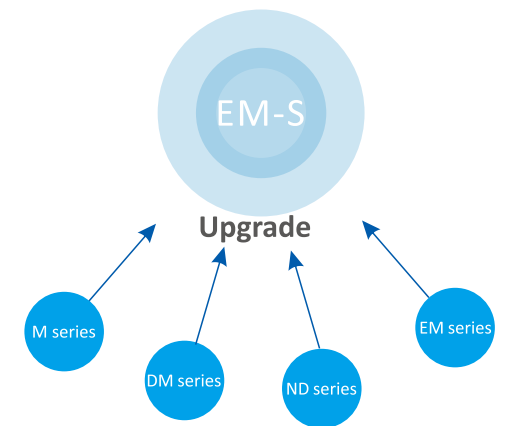

Torque comparison (same condition)

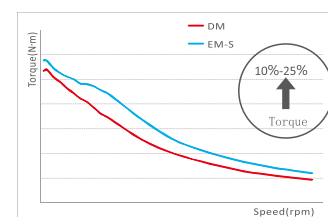

Pulse Smoothing Filter

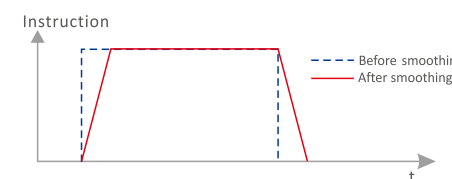

Alarm and Brake Outputs

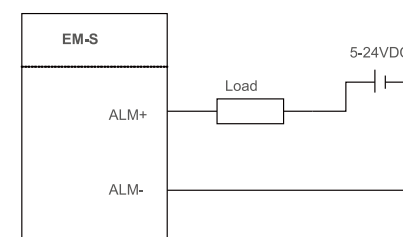

Features of Second DIP Switch

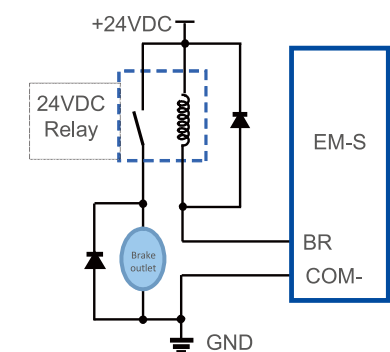
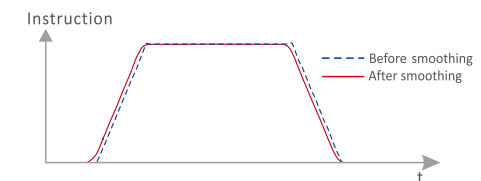
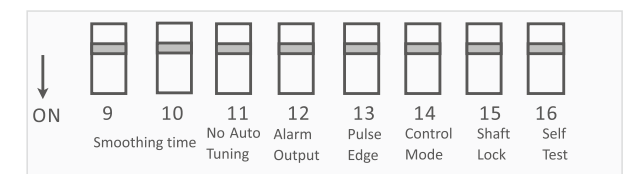

EM-S Series Electrical Specifications

Items	EM415S		EM422S		EM542S		EM556S		EM870S		EM882S	
	Min	Max	Min	Max	Min	Max	Min	Max	Min	Max	Min	Max
Output Current (A)	0.3	1.5	0.3	22	0.5	4.2	0.5	4.2	0.5	7.0	0.5	8.2
Power Voltage (VDC)	12	40	12	40	20	50	20	50	20	80	20	80
Max Input Frequency (KHz)	-	70	-	70	-	200	-	200 or 500*	-	200	-	200 or 500*
Logical Current (mA)	7	16	7	16	7	16	7	16	7	16	7	16
Logical Voltage (VDC)	0	5	0	5	0	5 or 24	0	5 or 24	0	5 or 24	0	5
Min Pulse Width (us)	7.5		7.5		2.5		2.5 or 1		2.5		2.5 or 1	
Matched Motors Size	NEMA8/11/14/17		NEMA17		NEMA17/23		NEMA23/24		NEMA23/24/34		NEMA34	

Note: (*) The drive with 500KHz is another model.

EM-S Series Connector and Mechanical

